

A close-up photograph of an American flag, showing the blue field with white stars and the red and white stripes, draped over the right side of the page.

Flags Flagpoles Accessories

2024 CATALOG





Quality • Customer Service • American Craftsmanship



ALL OF OUR U.S. FLAGS ARE PROUDLY MADE IN AMERICA!



| | |
|---|----------------|
| U.S. FLAGS..... | 2-15 |
| Outdoor..... | 2-7 |
| Outdoor Sets..... | 8-9 |
| Indoor & Sets..... | 10-11 |
| Mounted..... | 12-13 |
| Fans, Decorations & Bunting..... | 14-15 |
| FLAG TYPES, MATERIALS AND ADD-ONS..... | 16 |
| STATE & TERRITORY FLAGS..... | 17-23 |
| FLAGS OF THE WORLD..... | 24-44 |
| RELIGIOUS FLAGS & SETS..... | 45-46 |
| INDOOR & PARADE ACCESSORIES..... | 47-56 |
| Ornaments..... | 47-49 |
| Floor Stands & Flagpoles..... | 50-53 |
| Accessories & Table Bases..... | 54-56 |
| HISTORICAL FLAGS OF THE U.S..... | 57-60 |
| MILITARY AND CIVILIAN SERVICE..... | 61-67 |
| Military..... | 62-65 |
| Civilian Service..... | 66 |
| Memorial Markers & Cases..... | 67 |
| NAUTICAL FLAGS..... | 68-70 |
| SPECIALTY FLAGS..... | 71-76 |
| Celebration & Specialty..... | 71-72 |
| Message..... | 73-74 |
| Racing & Sports..... | 75-76 |
| ATTENTION FLAGS..... | 77-78 |
| CUSTOM FLAGS & BANNERS..... | 79-81 |
| BRACKETS, HOLDERS & ACCESSORIES..... | 82-88 |
| OUTDOOR FLAGPOLES..... | 89-120 |
| OUTDOOR FLAGPOLE ACCESSORIES..... | 121-162 |
| Ornaments..... | 121-122 |
| Trucks & Accessories..... | 123-127 |
| Cleats, Halyard, Snaps..... | 128-133 |
| Internal Halyard Parts..... | 134-140 |
| Flash Collars..... | 141-142 |
| Sleeves, Lights & Misc..... | 143-145 |
| FLAG ETIQUETTE..... | 146-147 |
| NOTES..... | 148-149 |
| Lifetime Warranty..... | 148 |
| Terms & Conditions..... | 149 |



Page 144



Page 71



Page 92

POLY-MAX™ U.S. FLAGS

Our Poly-Max Flags are crafted using 2-ply 100% polyester bunting. The open weave construction reduces wind resistance, increasing flag life. Poly-Max material is extremely durable and ideal for commercial applications and high wind areas. Finished with white poly-cotton header. See [page 5](#) for additional flag specifications.



3' x 5' Poly-Max Flag



| MODEL | ITEM # | SIZE | 1-5 | 6-11 | 12+ | LBS. | QTY/Case |
|-------|--------|-------------|-----------|-----------|-----------|------|----------|
| PF5 | 010045 | 3' x 5' | \$66.20 | \$57.40 | \$54.70 | .95 | 25 |
| PF6 | 010046 | 4' x 6' | 92.70 | 81.00 | 76.70 | 1.4 | 15 |
| PF8 | 010047 | 5' x 8' | 146.60 | 126.60 | 119.40 | 2.2 | 10 |
| PF9 | 010048 | 5' x 9-1/2' | 172.00 | 157.00 | 145.00 | 2.8 | 10 |
| PF10 | 010049 | 6' x 10' | 222.00 | 193.00 | 179.00 | 3.2 | 6 |
| PF12 | 010050 | 8' x 12' | 324.00 | 318.00 | 303.00 | 5.1 | 3 |
| PF15 | 010051 | 10' x 15' | 496.00 | 492.00 | 466.00 | 7.6 | 2 |
| PF19 | 010052 | 10' x 19' | 583.00 | 569.00 | 538.00 | 9.0 | 2 |
| PF18 | 010053 | 12' x 18' | 677.00 | 663.00 | 633.00 | 11 | 1 |
| PF25 | 010054 | 15' x 25' | 1,210.00 | 1,180.00 | 1,150.00 | 18 | 1 |
| PF30 | 010055 | 20' x 30' | 1,860.00 | 1,830.00 | 1,750.00 | 32 | 1 |
| PF38 | 010056 | 20' x 38' | 2,110.00 | 2,080.00 | 2,020.00 | 38 | 1 |
| PF40 | 010057 | 25' x 40' | 2,830.00 | 2,770.00 | 2,740.00 | 50 | 1 |
| PF50 | 010058 | 30' x 50' | 4,280.00 | 4,180.00 | 4,030.00 | 82 | 1 |
| PF60 | 010059 | 30' x 60' | 5,000.00 | 4,790.00 | 4,530.00 | 92 | 1 |
| PF70 | 010292 | 40' x 70' | 12,590.00 | 12,270.00 | 11,900.00 | 143 | 1 |
| PF75 | 010294 | 40' x 75' | 13,290.00 | 12,940.00 | 12,620.00 | 153 | 1 |
| PF80* | 010298 | 50' x 80' | 13,840.00 | 13,500.00 | 13,160.00 | 204 | 1 |

*The PF80 is not intended to be used on a flagpole. This size in polyester would be for display purposes only.

WITH VERTICAL STITCHING & REINFORCED CORNERS

Includes ADDITIONAL zigzag stitching reinforcement: 4 vertical rows on fly end & zigzag stitching on fly end corners (see illustration on [page 4](#)).

| MODEL | ITEM # | SIZE | 1-5 | 6-11 | 12+ | LBS. | QTY/Case |
|---------|--------|-------------|-----------|-----------|-----------|------|----------|
| PF5-VS | 010061 | 3' x 5' | \$91.20 | \$82.40 | \$79.70 | .95 | 25 |
| PF6-VS | 010062 | 4' x 6' | 120.20 | 108.50 | 104.20 | 1.4 | 15 |
| PF8-VS | 010063 | 5' x 8' | 178.60 | 158.60 | 151.40 | 2.2 | 10 |
| PF9-VS | 010064 | 5' x 9-1/2' | 204.00 | 189.00 | 177.00 | 2.8 | 10 |
| PF10-VS | 010065 | 6' x 10' | 263.00 | 233.00 | 220.00 | 3.2 | 6 |
| PF12-VS | 010066 | 8' x 12' | 376.00 | 370.00 | 354.00 | 5.1 | 3 |
| PF15-VS | 010067 | 10' x 15' | 571.00 | 567.00 | 541.00 | 7.6 | 2 |
| PF19-VS | 010068 | 10' x 19' | 658.00 | 644.00 | 613.00 | 9.0 | 2 |
| PF18-VS | 010069 | 12' x 18' | 762.00 | 748.00 | 718.00 | 11 | 1 |
| PF25-VS | 010070 | 15' x 25' | 1,300.00 | 1,280.00 | 1,240.00 | 18 | 1 |
| PF30-VS | 010071 | 20' x 30' | 1,980.00 | 1,960.00 | 1,870.00 | 32 | 1 |
| PF38-VS | 010072 | 20' x 38' | 2,230.00 | 2,200.00 | 2,140.00 | 38 | 1 |
| PF40-VS | 010073 | 25' x 40' | 2,980.00 | 2,920.00 | 2,890.00 | 50 | 1 |
| PF50-VS | 010074 | 30' x 50' | 4,470.00 | 4,360.00 | 4,210.00 | 82 | 1 |
| PF60-VS | 010075 | 30' x 60' | 5,180.00 | 4,970.00 | 4,720.00 | 92 | 1 |
| PF70-VS | 010293 | 40' x 70' | 12,980.00 | 12,660.00 | 12,290.00 | 143 | 1 |
| PF75-VS | 010295 | 40' x 75' | 13,680.00 | 13,330.00 | 13,010.00 | 153 | 1 |
| PF80-VS | 010301 | 50' x 80' | 14,330.00 | 13,990.00 | 13,650.00 | 204 | 1 |

*Individual U.S. flag can be purchased with any commercial grade flagpole listed on [pages 100-118](#).

ENDURA-NYLON™ U.S. FLAGS

Our Endura-Nylon flags are crafted using aniline-dyed 100% heavyweight 200-denier nylon bunting. Endura-Nylon material is fast drying, treated to resist fading and flies in the slightest breeze. Finished with white poly-cotton header. See [page 5](#) for additional flag specifications.



| MODEL | ITEM # | SIZE | 1-5 | 6-11 | 12+ | LBS. | QTY/Case |
|-------|--------|-------------|-----------|-----------|-----------|------|----------|
| NF5 | 010005 | 3' x 5' | \$53.70 | \$48.20 | \$43.60 | .60 | 40 |
| NF6 | 010006 | 4' x 6' | 66.00 | 61.50 | 57.00 | .85 | 25 |
| NF8 | 010007 | 5' x 8' | 103.40 | 95.90 | 88.20 | 1.3 | 20 |
| NF9 | 010008 | 5' x 9-1/2' | 131.00 | 109.80 | 104.90 | 1.5 | 15 |
| NF10 | 010009 | 6' x 10' | 145.00 | 140.00 | 129.00 | 1.9 | 12 |
| NF12 | 010010 | 8' x 12' | 269.00 | 261.00 | 239.00 | 3.1 | 8 |
| NF15 | 010011 | 10' x 15' | 393.00 | 390.00 | 374.00 | 4.4 | 5 |
| NF19 | 010012 | 10' x 19' | 441.00 | 436.00 | 421.00 | 5.5 | 3 |
| NF18 | 010013 | 12' x 18' | 526.00 | 524.00 | 510.00 | 6.5 | 3 |
| NF25 | 010014 | 15' x 25' | 930.00 | 910.00 | 850.00 | 11 | 2 |
| NF30 | 010015 | 20' x 30' | 1,250.00 | 1,190.00 | 1,080.00 | 17 | 1 |
| NF38 | 010016 | 20' x 38' | 1,450.00 | 1,390.00 | 1,250.00 | 20 | 1 |
| NF40 | 010017 | 25' x 40' | 2,030.00 | 2,020.00 | 2,010.00 | 34 | 1 |
| NF50 | 010018 | 30' x 50' | 2,850.00 | 2,840.00 | 2,690.00 | 44 | 1 |
| NF60 | 010019 | 30' x 60' | 3,380.00 | 3,280.00 | 3,050.00 | 54 | 1 |
| NF80 | 010297 | 50' x 80' | 12,080.00 | 11,420.00 | 10,270.00 | 119 | 1 |

3' x 5' Endura-Nylon Flag



3' X 5' ENDURA-NYLON II U.S. OUTDOOR FLAGS

WITH EMBROIDERED STARS, SEWN STRIPES AND CHAIN-STITCHING

Identical to Endura-Nylon Flag Item #010005, except the stripes are chain-stitched instead of lock-stitched.

Case Pack Orders Only*

| ITEM # | 12+ | LBS. | QTY/Case |
|--------|---------|------|----------|
| 010262 | \$34.50 | .60 | 40 |

WITH VERTICAL STITCHING & REINFORCED CORNERS

Includes ADDITIONAL zigzag stitching reinforcement: 4 vertical rows on fly end & zigzag stitching on fly end corners (see illustration on [page 4](#)).

| MODEL | ITEM # | SIZE | 1-5 | 6-11 | 12+ | LBS. | QTY/Case |
|---------|--------|-------------|-----------|-----------|-----------|------|----------|
| NF5-VS | 010025 | 3' x 5' | \$78.70 | \$73.20 | \$68.60 | .60 | 40 |
| NF6-VS | 010026 | 4' x 6' | 93.50 | 89.00 | 84.50 | .85 | 25 |
| NF8-VS | 010027 | 5' x 8' | 135.40 | 127.90 | 120.20 | 1.3 | 20 |
| NF9-VS | 010028 | 5' x 9-1/2' | 163.00 | 141.80 | 136.90 | 1.5 | 15 |
| NF10-VS | 010029 | 6' x 10' | 186.00 | 181.00 | 169.00 | 1.9 | 12 |
| NF12-VS | 010030 | 8' x 12' | 320.00 | 312.00 | 290.00 | 3.1 | 8 |
| NF15-VS | 010031 | 10' x 15' | 468.00 | 465.00 | 449.00 | 4.4 | 5 |
| NF19-VS | 010032 | 10' x 19' | 516.00 | 511.00 | 496.00 | 5.5 | 3 |
| NF18-VS | 010033 | 12' x 18' | 611.00 | 609.00 | 595.00 | 6.5 | 3 |
| NF25-VS | 010034 | 15' x 25' | 1,030.00 | 1,000.00 | 950.00 | 11 | 2 |
| NF30-VS | 010035 | 20' x 30' | 1,370.00 | 1,320.00 | 1,210.00 | 17 | 1 |
| NF38-VS | 010036 | 20' x 38' | 1,580.00 | 1,510.00 | 1,370.00 | 20 | 1 |
| NF40-VS | 010037 | 25' x 40' | 2,180.00 | 2,170.00 | 2,160.00 | 34 | 1 |
| NF50-VS | 010038 | 30' x 50' | 3,040.00 | 3,030.00 | 2,870.00 | 44 | 1 |
| NF60-VS | 010039 | 30' x 60' | 3,560.00 | 3,460.00 | 3,230.00 | 54 | 1 |
| NF80-VS | 010305 | 50' x 80' | 12,570.00 | 11,910.00 | 10,760.00 | 119 | 1 |

*Individual U.S. flag can be purchased with any commercial grade flagpole listed on [pages 100-118](#).



VERTICAL STITCHING & REINFORCED CORNERS

Can be added to any flag in this catalog.

| SIZE | PRICE | SIZE | PRICE | SIZE | PRICE |
|-------------|---------|-----------|---------|-----------|----------|
| 3' x 5' | \$25.00 | 10' x 15' | \$75.00 | 25' x 40' | \$147.00 |
| 4' x 6' | 27.50 | 10' x 19' | 75.00 | 30' x 50' | 183.00 |
| 5' x 8' | 32.00 | 12' x 18' | 85.00 | 30' x 60' | 183.00 |
| 5' x 9-1/2' | 32.00 | 15' x 25' | 98.00 | 40' x 70' | 393.00 |
| 6' x 10' | 40.50 | 20' x 30' | 123.00 | 40' x 75' | 393.00 |
| 8' x 12' | 51.50 | 20' x 38' | 123.00 | 50' x 80' | 490.00 |

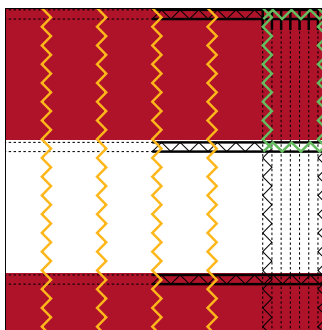

VERTICAL STITCHING & REINFORCED CORNERS (SHOWN ON A 25' X 40' OR LARGER FLAG).

Yellow represents the extra vertical stitching and green represents the reinforced corners.

U.S. FLAG FEATURES

STARS

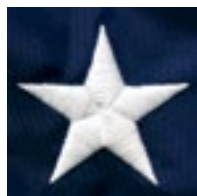

EMBROIDERED STARS

12' x 18' and smaller flags come standard with embroidered white stars.



APPLIQUED STARS

15' x 25' and larger flags have opaque white nylon stars with zigzag stitching throughout.

HEADER FEATURES

HEADERS

All headers are made with a heavy-duty, white cotton-polyester blend army duck cloth.



ROPE THIMBLE

8' x 12' and larger flags include plated steel rope thimbles. Thimbles are attached to white rope using a triple crimped rope sleeve. The length of the rope is sewn into the header to stabilize its position and prevent bunching.



8' x 12' to 15' x 25'

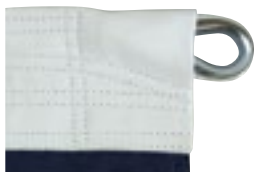

20' x 30' & larger

GROMMET REINFORCEMENT

8' x 12' and larger flags include a heavy-duty plastic reinforcement sleeve at each grommet location.



8' x 12' to 15' x 25'



20' x 30' & larger

GROMMETS

All grommets are solid brass. Grommets are spaced evenly throughout the length of the header. 12" x 18" flags have #1 grommets and 16" x 24" and larger flags have #2 grommets.



#1 Flat Rimmed



#2 Rolled Rimmed with tooth washer

CORNER PATCHES

10' x 15' and larger flags include a 2-ply corner patch sewn into each header corner.



Top Corner Patch



Bottom Corner Patch

All of our Poly-Max Flags and Endura-Nylon Flags on [pages 2-3](#) are identical to the sewing specifications above.

U.S. FLAG FEATURES

FLY STITCHING REINFORCEMENTS

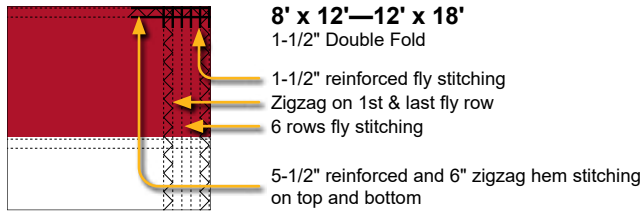
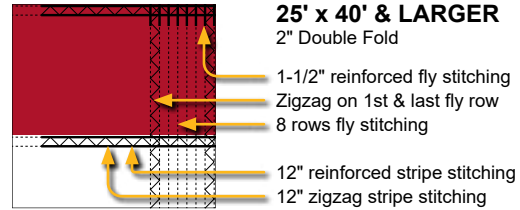
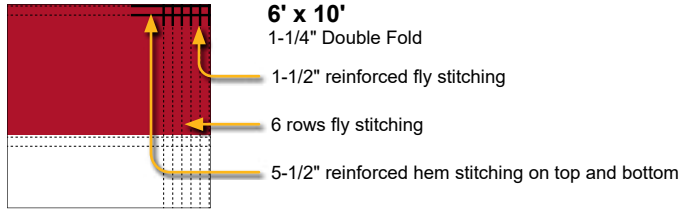
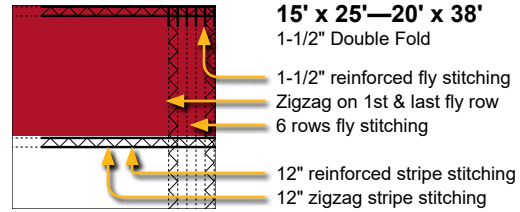
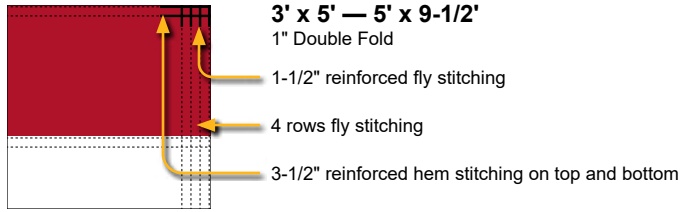

U.S. FLAG SPECIFICATIONS

| FLAG SIZE | HEADER WIDTH | Fly End Lock Stitching | NO. OF THIMBLES | NO. OF GROMMETS | GROMMET REINFORCEMENT | CORNER PATCHES | Zig Zag Patch on each fly end corner | STARS |
|-------------|--------------|------------------------|-----------------|-----------------|-----------------------|----------------|--------------------------------------|-------------|
| 3' x 5' | 1-1/2" | 4 rows | — | 2 | — | — | — | Embroidered |
| 4' x 6' | 1-1/2" | 4 rows | — | 2 | — | — | — | Embroidered |
| 5' x 8' | 1-1/2" | 4 rows | — | 2 | — | — | — | Embroidered |
| 5' x 9-1/2' | 1-1/2" | 4 rows | — | 2 | — | — | — | Embroidered |
| 6' x 10' | 2" | 6 rows | — | 2 | — | — | — | Embroidered |
| 8' x 12' | 2" | 6 rows | 2 | 1 | Yes | — | Yes | Embroidered |
| 10' x 15' | 2" | 6 rows | 2 | 1 | Yes | Yes | Yes | Embroidered |
| 10' x 19' | 2" | 6 rows | 2 | 1 | Yes | Yes | Yes | Embroidered |
| 12' x 18' | 2" | 6 rows | 2 | 1 | Yes | Yes | Yes | Embroidered |
| 15' x 25' | 2" | 6 rows | 2 | 3 | Yes | Yes | Yes | Applied |
| 20' x 30' | 3" doubled | 6 rows | 2 | 3 | Yes | Yes | Yes | Applied |
| 20' x 38' | 3" doubled | 6 rows | 2 | 3 | Yes | Yes | Yes | Applied |
| 25' x 40' | 3" doubled | 8 rows | 2 | 5 | Yes | Yes | Yes | Applied |
| 30' x 50' | 3" doubled | 8 rows | 2 | 7 | Yes | Yes | Yes | Applied |
| 30' x 60' | 3" doubled | 8 rows | 2 | 7 | Yes | Yes | Yes | Applied |
| 40' x 70' | 3" doubled | 8 rows | 2 | 9 | Yes | Yes | Yes | Applied |
| 40' x 75' | 3" doubled | 8 rows | 2 | 9 | Yes | Yes | Yes | Applied |
| 50' x 80' | 3" doubled | 8 rows | 2 | 11 | Yes | Yes | Yes | Applied |

We recommend that all grommets installed in the larger flags be used to secure the flag to the halyard.

All of our Poly-Max Flags and Endura-Nylon Flags on [pages 2-3](#) are identical to the sewing specifications above.



ENDURA-NYLON U.S. OUTDOOR BANNER FLAGS
EMBROIDERED STARS AND SEWN STRIPES

These flags can replace any decorative flag or banner. Finished with white pole sleeve and leather tab.

| ITEM # | SIZE | 1-5 | 6-11 | 12-35 | 36+ | LBS. |
|--------|---------|---------|---------|---------|---------|------|
| 010041 | 3' x 5' | \$60.80 | \$55.30 | \$49.20 | \$45.70 | .60 |



ENDURA-TEX™ COTTON U.S. OUTDOOR FLAGS
EMBROIDERED STARS AND SEWN STRIPES

Our Endura-Tex™ U.S. Flags are carefully manufactured using traditional heavyweight 2x2 ply mercerized cotton bunting. Extra rugged weave actually exceeds U.S. Government specifications and the most modern dyeing techniques ensure brilliant colors that are fast to sun and rain.

Case Pack Orders Only

| MODEL | ITEM # | SIZE | 1-5 | 6-11 | 12+ | QTY/Case | LBS. |
|-------|--------|-------------|-----|----------|---------|----------|------|
| CF5 | 010078 | 3' x 5' | — | — | \$53.90 | 25 | .85 |
| CF9 | 010081 | 5' x 9-1/2' | — | \$146.00 | 143.00 | — | 2.3 |



FLY ENDS

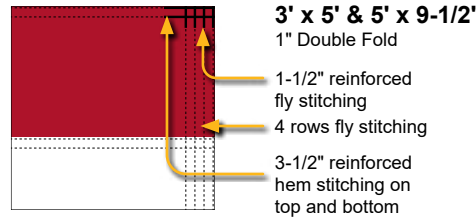

HEADERS

HEADER: 1-1/2" heavy-duty, bright white cotton polyester blend army duck cloth.

GROMMETS: Two solid brass #2 rolled rimmed with tooth washer grommets.





SUN-BRITE™ NYLON U.S. FLAGS

These flags are ideal for residential or commercial applications. Sun-Brite™ Flags are fully printed on SolarMax nylon using our aniline dyeing process.

| ITEM # | SIZE | 1-5 | 6-11 | 12-35 | 36+ | LBS. |
|--------|-----------|---------|---------|---------|---------|------|
| 010093 | 12" x 18" | \$15.50 | \$14.60 | \$14.20 | \$12.60 | .07 |
| 010096 | 2' x 3' | 38.00 | 37.10 | 36.60 | 36.10 | .21 |
| 010259 | 4' x 6' | 84.00 | — | — | — | .70 |
| 010260 | 5' x 8' | 121.00 | — | — | — | 1.0 |

FLY ENDS

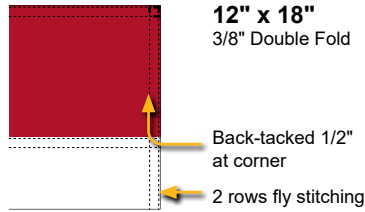
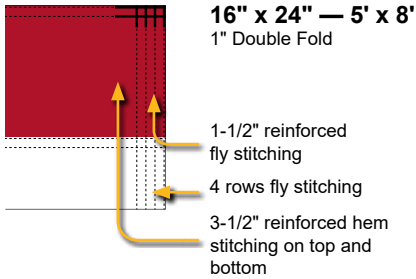

HEADERS



12" x 18"
HEADER: 1" heavy-duty, bright white cotton polyester blend army duck cloth.
GROMMETS: Two solid brass #1 flat rimmed grommets.



16" x 24" — 5' x 8'
HEADER: 1-1/2" heavy-duty, bright white cotton polyester blend army duck cloth.
GROMMETS: Two solid brass #2 rolled rimmed with tooth washer grommets.



ENDURA-PC™ U.S. OUTDOOR FLAG

This fully printed poly-cotton flag has the look and feel of a cotton flag with the advantages of a polyester flag. Double-stitched fly ends and canvas header with brass grommets.

| ITEM # | SIZE | 1-23 | 24-71 | 72-143 | 144+ | LBS. |
|--------|---------|---------|---------|---------|---------|------|
| 010125 | 3' x 5' | \$23.00 | \$17.00 | \$16.30 | \$15.70 | .40 |



ALL OF OUR U.S. FLAGS ARE PROUDLY MADE IN AMERICA!



Economy Endura-Nylon Set (010152) pictured

ECONOMY FLAG SET PARTS



STANDARD FLAG SET PARTS



DELUXE FLAG SET PARTS



3' X 5' U.S. OUTDOOR FLAG SETS

| TYPE | POLE SIZE | POLE MATERIAL | PLASTIC EAGLE | STAMPED STEEL BRACKET | FLAG MOUNTINGS |
|----------|----------------------|-----------------|---------------|-----------------------|---------------------|
| ECONOMY | 6' x 3/4" 3-PIECE | SILVER STEEL | GOLD | SILVER | NYLON FLAG TIES |
| STANDARD | 6' x 3/4" 3-PIECE | SILVER ALUMINUM | GOLD | SILVER | EZ-MOUNT FLAG RINGS |
| DELUXE | 6' x 3/4" 3-PIECE | GOLD ALUMINUM | BRASS PLATED | GOLD | EZ-MOUNT FLAG RINGS |

In addition to the above, each flag set includes a flag, mounting screws and flag etiquette booklet.

3' X 5' ENDURA-PC™ U.S. OUTDOOR FLAG SETS

See [Page 7](#) For Flag Description

| ITEM # | HARDWARE | 1-23 | 24-71 | 72-143 | 144+ | LBS. |
|--------|----------|---------|---------|---------|---------|------|
| 010152 | ECONOMY | \$27.00 | \$25.50 | \$24.00 | \$23.00 | 1.8 |
| 010153 | STANDARD | 33.50 | 32.50 | 30.50 | 29.50 | 1.6 |

MOUNTING SETS ONLY

No Flag • Individually Poly-Bagged

| ITEM # | HARDWARE | 1-23 | 24-71 | 72-143 | 144+ | LBS. |
|--------|----------|---------|---------|---------|---------|------|
| 010160 | ECONOMY | \$13.60 | \$12.70 | \$12.10 | \$11.40 | 1.0 |
| 010162 | DELUXE | 25.00 | 24.50 | 24.00 | 23.50 | .90 |

REPLACEMENT PARTS FOR FLAG SETS

PLASTIC SLIP FIT EAGLES

See [pg. 47](#) for more Slip Fit Eagles

| FOR POLE | HT. | WING SPAN | LBS. | BRASS PLATED | | GOLD GILT | |
|---------------|--------|-----------|------|--------------|--------|-----------|--------|
| | | | | ITEM # | PRICE | ITEM # | PRICE |
| 3/4" ALUMINUM | 3-1/4" | 4-1/4" | .05 | 050031 | \$5.02 | — | — |
| 3/4" STEEL | 3-1/4" | 4-1/4" | .05 | 050032 | 5.02 | 050035 | \$1.78 |

STAMPED STEEL BRACKETS

See [pg. 85](#) for more Stamped Steel Brackets

| ITEM # | COLOR | FOR POLE DIA. | 1-71 | 72-143 | 144+ | LBS. |
|--------|--------|---------------|--------|--------|--------|------|
| 310058 | SILVER | 1" | \$8.20 | \$6.50 | \$6.20 | .40 |
| 310061 | GOLD | 3/4" | 5.28 | 4.26 | 4.08 | .20 |
| 310062 | GOLD | 1" | 10.30 | 8.50 | 7.90 | .40 |

CLEAR PLASTIC EZ-MOUNT FLAG RINGS

See [pg. 87](#) for more EZ-Mount Flag Rings • Priced Per Ring

| ITEM # | MODEL | FOR POLE DIA. | 1-71 | 72-143 | 144+ | LBS. |
|--------|-------|---------------|--------|--------|--------|------|
| 310104 | EZ-34 | 3/4" | \$1.56 | \$1.32 | \$1.24 | .02 |
| 310106 | EZ-1 | 1" | 1.56 | 1.32 | 1.24 | .02 |

NYLON FLAG TIES

See [pg. 87](#) for more Nylon Flag Ties

| ITEM # | MODEL | MAX. POLE DIA. | 1-71 | 72-143 | 144+ | LBS. |
|--------|-------|----------------|--------|--------|--------|------|
| 310110 | NFT4 | 3/4" | \$0.50 | \$0.38 | \$0.30 | .001 |
| 310111 | NFT8 | 2" | 1.00 | 0.84 | 0.66 | .004 |

REGAL FLAG SETS

WITH YOUR CHOICE OF 6' WHITE OR BLACK FIBERGLASS POLE



- NeverFurl Flag Unfurler ([pg.88](#))
- Solid Brass Acorn Ornament ([pg.49](#))
- Solid Brass Mounting Bracket w/Mounting Screws ([pg.85](#))
- 6' Fiberglass Pole ([pg.90](#))



SPINNING POLE FLAG SETS

WITH YOUR CHOICE OF 6' SILVER OR WHITE ALUMINUM POLE



- ★ Flag made in USA
- ★ Pole keeps flag unfurled
- ★ Bracket adjusts to 13 different positions including vertical and horizontal

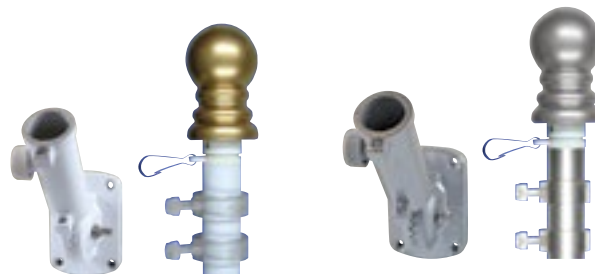

COMPLETE SETS WITH 6' POLE & 3' X 5' NYLON U.S. FLAG

| ITEM # | POLE | 1-11 | 12-23 | 24+ | LBS. |
|--------|------------|----------|----------|----------|------|
| 010256 | 3/4" BLACK | \$138.50 | \$130.00 | \$127.00 | 4.3 |
| 010275 | 1" WHITE | 163.00 | 157.00 | 151.00 | 4.7 |
| 010277 | 1" BLACK | 163.00 | 157.00 | 151.00 | 4.7 |

COMPLETE SETS WITH 6' POLE - NO FLAG

| ITEM # | POLE | 1-11 | 12-23 | 24+ | LBS. |
|--------|------------|----------|---------|---------|------|
| 010257 | 3/4" BLACK | \$101.00 | \$90.50 | \$87.50 | 3.6 |
| 010276 | 1" WHITE | 122.00 | 114.00 | 109.00 | 4.1 |
| 010278 | 1" BLACK | 122.00 | 114.00 | 109.00 | 4.1 |



- 3' x 5' Endura-Nylon II U.S. Outdoor Flag ([pg.3](#))
- 6' Aluminum Anti-Furl Rotating Pole with Ball Ornament and EZ-Mount Flag Rings ([pg.89](#))
- Aluminum Ultimate Adjustable Bracket w/Mounting Screws ([pg.84](#))

| ITEM # | FINISH | 1-11 | 12-23 | 24+ | LBS. |
|--------|---------------------------|---------|---------|---------|------|
| 010334 | SILVER POLE / SILVER BALL | \$91.50 | \$87.50 | \$82.00 | 3.8 |
| 010335 | WHITE POLE / GOLD BALL | 89.00 | 84.50 | 80.00 | 3.8 |



DELUXE U.S. NYLON INDOOR/PARADE FLAG SETS

All sets include a brass plated metal eagle ornament, a gold cord & tassel, a 2-piece pole with brass screw joint and a gold anodized Endura floor stand.

All Complete Sets also include a U.S. Nylon Flag with embroidered stars and sewn stripes, pole hem, leather tabs and gold fringe.



Perched Eagle



Flying Eagle

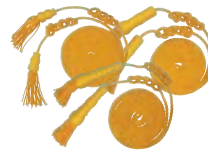

Cord & Tassel

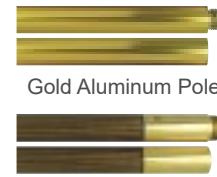

Gold Aluminum Pole



Oak Pole



Endura™ Stand

WITH GOLD ALUMINUM POLES

| ITEM # | MODEL | TYPE | FLAG SIZE | POLE SIZE | EAGLE TYPE | EAGLE HT. | EAGLE WING SPAN | STAND DIA. | PRICE | LBS. |
|--------|----------|-------------------|-----------|--------------|------------|-----------|-----------------|------------|-----------------|------|
| 010166 | FA-301 | COMPLETE SET | 3' x 5' | 8' x 1-1/8" | PERCHED | 6-3/4" | 7-1/2" | 12" | \$310.00 | 20 |
| 010302 | FA-301MS | MOUNTING SET ONLY | — | 8' x 1-1/8" | PERCHED | 6-3/4" | 7-1/2" | 12" | 228.00 | 19 |
| 010168 | FA-46 | COMPLETE SET | 4' x 6' | 9' x 1-1/8" | PERCHED | 6-3/4" | 7-1/2" | 12" | 360.00 | 22 |
| 010169 | FA-303 | COMPLETE SET | 5' x 8' | 11' x 1-1/8" | PERCHED | 6-3/4" | 7-1/2" | 12" | 450.00 | 22 |

WITH OAK POLES

| ITEM # | MODEL | TYPE | FLAG SIZE | POLE SIZE | EAGLE TYPE | EAGLE HT. | EAGLE WING SPAN | STAND DIA. | PRICE | LBS. |
|--------|----------|-------------------|-----------|-------------|------------|-----------|-----------------|------------|-----------------|------|
| 010170 | F-300 | COMPLETE SET | 2' x 3' | 7' x 15/16" | PERCHED | 5" | 5" | 9" | \$236.00 | 13 |
| 010172 | FW-301 | COMPLETE SET | 3' x 5' | 8' x 1-1/8" | PERCHED | 6-3/4" | 7-1/2" | 12" | 320.00 | 22 |
| 010303 | FW-301MS | MOUNTING SET ONLY | — | 8' x 1-1/8" | PERCHED | 6-3/4" | 7-1/2" | 12" | 231.00 | 21 |
| 010174 | FW-46 | COMPLETE SET | 4' x 6' | 9' x 1-1/8" | PERCHED | 6-3/4" | 7-1/2" | 12" | 350.00 | 23 |



FREEDOM FLAG SET

- Hi-Impact, Shiny Gold Plated ABS Styrene Perched Eagle Ornament
- 3' x 5' Nylon U.S. Flag with Embroidered Stars, Sewn Stripes, Pole Hem and Gold Fringe
- Gold Cord & Tassel
- 8' x 1-1/4" Oak Pole with Precision Machined Brass Screw Joint
- 12" Diameter Shiny Gold Plated Plastic Regent Floor Stand



Gold Perched Eagle



Cord & Tassel



Oak Pole



Regent Stand

| ITEM # | MODEL | EAGLE HT. | WING SPAN | 1-5 | 6+ | LBS. |
|--------|--------|-----------|-----------|-----------------|-----------------|------|
| 010289 | FFS-35 | 7" | 7-1/2" | \$287.00 | \$273.00 | 15 |

U.S. NYLON INDOOR/PARADE FLAGS

Complete with embroidered stars and sewn stripes, pole hem and leather tabs.

WITH GOLD FRINGE

| ITEM # | MODEL | SIZE | PRICE | LBS. |
|--------|-------|---------|----------------|------|
| 010175 | FN-5 | 2' x 3' | \$76.00 | .45 |
| 010177 | FN-3 | 3' x 5' | 89.40 | .80 |
| 010179 | FN-46 | 4' x 6' | 131.30 | 1.1 |
| 010180 | FN-7 | 5' x 8' | 204.00 | 1.7 |

WITHOUT FRINGE

| ITEM # | MODEL | SIZE | PRICE | LBS. |
|--------|--------|---------|----------------|------|
| 010181 | FNH-5 | 2' x 3' | \$59.80 | .35 |
| 010183 | FNH-3 | 3' x 5' | 66.00 | .65 |
| 010185 | FNH-46 | 4' x 6' | 85.50 | .90 |
| 010186 | FNH-7 | 5' x 8' | 170.00 | 1.3 |

Sets sold on this page are not intended for outdoor display.

INDOOR/PARADE MOUNTING SET

Comes complete with a brass plated eagle ornament (5" high with 5" wing span), gold cord & tassel, EZ-Mount flag rings, 2-piece 8' x 1" gold anodized aluminum pole with top adapter, and 12" diameter gold Viscount floor stand.



Perched Eagle



Cord & Tassel



EZ-Mount
Flag Rings



Gold Aluminum Pole
w/Ornament Adapter



Viscount Stand

COMPLETE SET

| ITEM # | PRICE | LBS. |
|--------|-----------------|------|
| 010270 | \$183.00 | 5.9 |

POLE ONLY

| ITEM # | 1-11 | 12+ | LBS. |
|--------|----------------|----------------|------|
| 050534 | \$62.50 | \$60.50 | 1.2 |

Pole includes 2 EZ-Mount flag rings

FLAG SPREADER

For 1" to 1-1/4" Outside Diameter Poles



The Spreader has a vinyl coated bracket pole attachment and sure-grip flag clips that hold the flag securely in place.

| ITEM # | 1-5 | 6+ | LBS. |
|--------|----------------|----------------|------|
| 050542 | \$33.50 | \$30.00 | .45 |

INDOOR MOUNTING SETS

- 8' x 1-1/4" Oak Pole with Precision Machined Brass Screw Joint
- 12" diameter Shiny Gold Plated Plastic Regent Floor Stand
- Gold Cord & Tassel
- Choice of either a shiny gold plated ABS styrene eagle or spear ornament



| ITEM # | DESCRIPTION | PRICE | LBS. |
|--------|-------------|-----------------|------|
| 050549 | w/EAGLE | \$216.00 | 14 |
| 050550 | w/SPEAR | 213.00 | 14 |

INDOOR FLAG SET BOX

This option is provided to accommodate shipping of either one or two complete sets. Please add the pricing at right to any flag set that has a 7' or 8' pole and we will pre-package your set(s) to ship as one unit. For added protection, accessories are boxed or wrapped individually in heavy-duty Kraft shipping paper before packaged in the Flag Set Box.



| ITEM # | DESCRIPTION | PRICE | LBS. |
|--------|-----------------------------|----------------|------|
| 010283 | WILL HOLD ONE COMPLETE SET | \$34.90 | 6.0 |
| 010284 | WILL HOLD TWO COMPLETE SETS | 34.90 | 6.0 |

Sets sold on this page are not intended for outdoor display.

ENDURA-GLOSS™ U.S. MOUNTED FLAGS

Beautifully printed on silk-like material, these flags offer the highest quality in a hand-held, desk or classroom flag. Hem stitched on all four sides for longer lasting beauty. Comes complete with a gold spear.



| ITEM # | FLAG SIZE | STAFF SIZE | STAFF MATERIAL | STAFF COLOR | 1-143 | 144+ | LBS. |
|--------|-----------|------------|----------------|-------------|--------|--------|------|
| 010196 | 8" x 12" | 1/4" x 18" | WOOD | BLACK | \$4.82 | \$4.60 | .05 |

LIGHTWEIGHT POLY-COTTON U.S. MOUNTED FLAGS

Printed on soft poly-cotton sheeting and hemmed on all four sides. All sizes come complete with a gold spear.

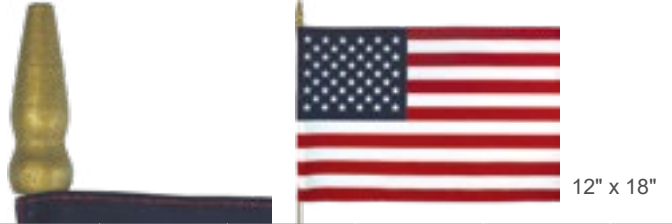

| ITEM # | FLAG SIZE | STAFF SIZE | STAFF MATERIAL | STAFF COLOR | 1-11 | 12-143 | 144-1439 | 1440+ | LBS. |
|--------|-----------|-------------|----------------|-------------|--------|--------|----------|--------|------|
| 010230 | 8" x 12" | 5/16" x 24" | WOOD | NATURAL | \$2.20 | \$2.12 | \$2.08 | \$2.02 | .07 |
| 010231 | 12" x 18" | 3/8" x 30" | WOOD | NATURAL | 3.70 | 3.56 | 3.44 | 3.18 | .13 |

PLASTIC U.S. MOUNTED FLAGS

3-1/2 mil virgin plastic. Mounted with a pole sleeve. Comes complete with a gold spear.



| ITEM # | FLAG SIZE | STAFF SIZE | STAFF MATERIAL | STAFF COLOR | 1-11 | 12-143 | 144-1439 | 1440+ | LBS. |
|--------|-----------|-------------|----------------|-------------|--------|--------|----------|--------|------|
| 010247 | 4" x 6" | 3/16" x 10" | PLASTIC | GOLD | \$0.68 | \$0.60 | \$0.54 | \$0.50 | .02 |



8" x 12"
#010286

NO-FRAY POLY-COTTON FLAGS W/ GOLD SPEARS

| ITEM # | FLAG SIZE | STAFF SIZE | STAFF MATERIAL | STAFF COLOR | 1-11 | 12-143 | 144-1439 | 1440+ | LBS. |
|--------|-----------|-------------|----------------|-------------|--------|--------|----------|--------|------|
| 010205 | 4" x 6" | 3/16" x 10" | WOOD | NATURAL | \$0.74 | \$0.70 | \$0.66 | \$0.62 | .02 |
| 010286 | 8" x 12" | 5/16" x 24" | WOOD | NATURAL | 1.64 | 1.58 | 1.46 | 1.32 | .05 |
| 010207 | 8" x 12" | 1/4" x 24" | WOOD | NATURAL | 1.60 | 1.54 | 1.42 | 1.28 | .05 |
| 010208 | 12" x 18" | 5/16" x 30" | WOOD | NATURAL | 2.52 | 2.34 | 2.22 | 2.10 | .10 |



4" x 6"

NO-FRAY POLY-COTTON FLAGSW/ GOLD BALLS

| ITEM # | FLAG SIZE | STAFF SIZE | STAFF MATERIAL | STAFF COLOR | 1-11 | 12-143 | 144-1439 | 1440+ | LBS. |
|--------|-----------|-------------|----------------|-------------|--------|--------|----------|--------|------|
| 010213 | 4" x 6" | 3/16" x 10" | WOOD | NATURAL | \$0.82 | \$0.80 | \$0.74 | \$0.72 | .02 |



4" x 6"

NO-FRAY POLY-COTTON FLAGS NO TIP

| ITEM # | FLAG SIZE | STAFF SIZE | STAFF MATERIAL | STAFF COLOR | 1-11 | 12-143 | 144-1439 | 1440+ | LBS. |
|--------|-----------|-------------|----------------|-------------|--------|--------|----------|--------|------|
| 010221 | 4" x 6" | 3/16" x 10" | WOOD | NATURAL | \$0.58 | \$0.52 | \$0.50 | \$0.46 | .02 |
| 010223 | 8" x 12" | 5/16" x 24" | WOOD | NATURAL | 1.62 | 1.58 | 1.38 | 1.24 | .05 |
| 010224 | 12" x 18" | 5/16" x 30" | WOOD | NATURAL | 2.44 | 2.26 | 2.12 | 1.98 | .10 |



ENDURA-GLOSS™ U.S. CLASSROOM BANNERS

These banners offer the highest quality in a classroom banner. Carefully hem-stitched on all four sides for longer lasting beauty. Mounted on black wood staff with gold spears. Comes with gold hanging cord and tassels.

| FLAG SIZE | STAFF SIZE | NO FRINGE | | | LBS. |
|-----------|------------|-----------|---------|---------|------|
| | | ITEM # | 1-11 | 12+ | |
| 12" x 18" | 1/4" x 12" | 010189 | \$14.10 | \$13.40 | .06 |



U.S. AUTO WINDOW FLAG

Comes complete with 11-1/2" x 14" U.S. polyester flag. Complete set supplied with 1-piece plastic bracket. Bracket only is a 2-piece plastic bracket. Custom flag designs are also available.

| ITEM # | DESCRIPTION | 1-23 | 24-71 | 72-143 | 144+ | LBS. |
|--------|----------------------|---------|---------|---------|---------|------|
| 010252 | COMPLETE SET | \$20.60 | \$20.30 | \$18.80 | \$18.00 | .30 |
| 010253 | 2-PIECE BRACKET ONLY | 10.50 | 9.60 | 8.80 | 8.40 | .25 |



COTTON PLEATED FANS - FULLY PRINTED

| SIZE | NO STARS - FULLY PRINTED | | | | WITH STARS - FULLY PRINTED | | | |
|-----------|--------------------------|---------|---------|------|----------------------------|---------|---------|------|
| | ITEM # | 1-11 | 12+ | LBS. | ITEM # | 1-11 | 12+ | LBS. |
| 18" x 36" | — | — | — | — | 160064 | \$22.10 | \$19.10 | .30 |
| 3' x 6' | 160007 | \$46.80 | \$37.90 | .75 | 160009 | 46.80 | 37.90 | .80 |



NYLON PLEATED FANS - FULLY SEWN, NO STARS

| SIZE | MODEL | ITEM # | 1-11 | 12+ | LBS. |
|-----------|--------|--------|---------|---------|------|
| 16" x 32" | — | 160011 | \$38.90 | \$36.20 | .30 |
| 27" x 54" | NFAN-1 | 160012 | 56.10 | 51.40 | .60 |
| 3' x 6' | NFAN-2 | 160013 | 64.00 | 59.10 | .80 |
| 4' x 8' | NFAN-3 | 160014 | 93.20 | 87.40 | 1.8 |
| 5' x 10' | NFAN-4 | 160015 | 144.80 | 132.90 | 3.2 |



3' X 3' PLEATED HALF FANS - FULLY SEWN, NO STARS

| ITEM # | MATERIAL | 1-11 | 12+ | LBS. |
|--------|----------|---------|---------|------|
| 160025 | NYLON | \$66.80 | \$62.30 | .95 |



POLY-COTTON ILLUSION FANS

Uniquely printed giving the effect of a traditional fully pleated fan.

| ITEM # | SIZE | 1-71 | 72+ | LBS. |
|--------|-----------|---------|---------|------|
| 160063 | 18" x 36" | \$15.70 | \$12.80 | .20 |
| 160001 | 3' x 6' | 31.00 | 28.20 | .40 |



ENDURA-POLY™ PLEATED FANS - FULLY PRINTED

| STYLE | ITEM # | SIZE | 1-11 | 12+ | LBS. |
|-----------|--------|---------|---------|---------|------|
| Americana | 160004 | 3' x 6' | \$40.80 | \$37.70 | .55 |

Americana

All fans come with Canvas Header & Brass Grommets



NYLON U.S. PULLDOWNS

EMBROIDERED STARS - SEWN STRIPES

With Canvas Header & Brass Grommets

| ITEM # | SIZE | 1-11 | 12+ | LBS. |
|--------|-----------|---------|---------|------|
| 160045 | 20" x 8' | \$34.10 | \$31.40 | .55 |
| 160046 | 20" x 10' | 37.80 | 35.10 | .60 |
| 160047 | 20" x 12' | 41.20 | 38.20 | .65 |

20" x 8' Shown



18" X 48" U.S. ECONOMY PULLDOWNS

FULLY PRINTED

With Canvas Header & Brass Grommets

| POLY-COTTON | ITEM # | 1-11 | 12+ | LBS. |
|-------------|--------|---------|---------|------|
| | 160054 | \$25.60 | \$22.60 | .20 |

FLAG PATTERN BUNTING

Cotton, hemmed on all four sides.

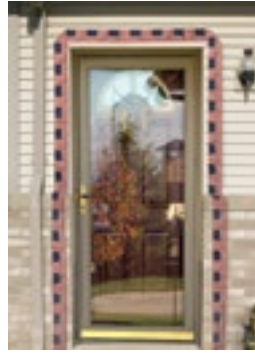

| ITEM # | PATTERN | SIZE | 1-11 | 12+ | LBS. |
|--------|-----------|-----------|---------|---------|------|
| 160066 | 8" x 12" | 8" x 24' | \$26.40 | \$24.80 | .84 |
| 160067 | 12" x 18" | 12" x 25' | 34.10 | 30.80 | 1.2 |



160058



160059



160068

COTTON RED, WHITE & BLUE BUNTING

| ITEM # | DESCRIPTION | STRIPES | STARS | WIDTH | LBS. | PER 5 YARDS* | |
|--------|---------------|---------|-------|-------|------|--------------|-----------|
| | | | | | | 5-65 YARDS | 70+ YARDS |
| 160058 | FULLY PRINTED | 5 | — | 36" | .20 | \$9.60 | \$8.10 |
| 160059 | FULLY PRINTED | 5 | YES | 36" | .20 | 9.60 | 8.10 |
| 160068 | FULLY PRINTED | 5 | YES | 18" | .10 | 5.60 | 4.80 |

* You may receive a seam



160060

NYLON RED, WHITE & BLUE BUNTING

| ITEM # | DESCRIPTION | STRIPES | STARS | WIDTH | LBS. | PER 5 YARDS* | |
|--------|-------------|---------|-------|-------|------|--------------|-----------|
| | | | | | | 5-65 YARDS | 70+ YARDS |
| 160060 | FULLY SEWN | 5 | — | 36" | .25 | \$15.50 | \$13.10 |

* You may receive a seam

MOUNTED FLAGS



4" x 6" Mounted E-Gloss



8" x 12" Mounted E-Gloss



4" x 6" Mounted Cotton No-Fray



4" x 6" Mounted Plastic



12" x 18" E-Poly on Natural Staff with Gold Spear



4" x 6" Fringed

ENDURA-GLOSS™

- Brilliantly printed on silk-like material.
- Hemmed on all four sides.
- 4" x 6" flags mounted on 3/16" x 10" black plastic staff with gold spear; 8" x 12" flags mounted on 1/4" x 18" black wood staff with gold spear.
- Highest quality mounted flag.
- **Ideal for desktop display.**

COTTON NO-FRAY

- Made of special no-fray material that doesn't require hemming.
- Mounted on 3/16" x 10" natural wood staff with no tip.
- **Ideal for larger promotions and giveaways.**

PLASTIC

- Made of 3-1/2 mil virgin plastic.
- Mounted with a pole sleeve on a 3/16" x 10" gold plastic staff with gold spear.

ENDURA-POLY™

- Printed on lightweight polyester.
- Hemmed on all four sides.
- State flags mounted on 5/16" x 30" natural wood staff with gold spear. Territory and World flags mounted on 1/4" x 24" natural wood staff with gold spear.
- **Most popular economy choice.**

MOUNTED FLAG FRINGE ADD-ON

Add the pricing below to any mounted flag (excluding plastic) to determine the cost of a fringed mounted flag.

| FLAG SIZE | FRINGE WIDTH | PRICE |
|-----------|--------------|---------------|
| 4" x 6" | 1/2" | \$3.50 |
| 8" x 12" | 1/2" | 6.50 |
| 12" x 18" | 2" | 7.50 |
| 16" x 24" | 2" | 9.50 |
| 24" x 36" | 2" | 14.00 |

OUTDOOR FLAGS



3' x 5' Outdoor Poly-Max



3' x 5' Outdoor Nylon



3' x 5' Outdoor Endura-Poly

POLY-MAX™

- Made of 2-ply 100% polyester bunting.
- Open weave construction reduces wind resistance, increasing flag life.
- Extremely durable.
- Finished with white header and brass grommets.
- **Ideal for commercial applications and high wind areas.**

ENDURA-NYLON™

- Made of 100% heavyweight, 200-denier nylon bunting.
- Aniline-dyed for brilliant, fast colors.
- Treated to resist fading.
- Fast drying.
- State, Territory and World flags constructed to precise specifications.
- Finished with white header and brass grommets.
- **Flies in the slightest breeze.**

ENDURA-POLY™

- Printed on lightweight polyester.
- Finished with white header and brass grommets.
- **Most popular economy choice.**

INDOOR / PARADE FLAGS

POLE HEM OR POLE HEM & FRINGE ADD-ON

Add the pricing below to any outdoor flag to determine the price for an indoor/parade flag. All pole hems include a leather tab for mounting flag on a pole. Fringe is 2" wide.



3' x 5' Indoor w/Pole Hem



3' x 5' Indoor w/Pole Hem & Fringe

| FLAG SIZE | POLE HEM ONLY |
|-----------|----------------|
| 2' x 3' | \$16.50 |
| 3' x 5' | 21.00 |
| 4' x 6' | 23.00 |
| 5' x 8' | 28.50 |
| 6' x 10' | 38.00 |

| FLAG SIZE | POLE HEM & FRINGE |
|-----------|-------------------|
| 2' x 3' | \$33.00 |
| 3' x 5' | 42.00 |
| 4' x 6' | 46.00 |
| 5' x 8' | 59.00 |
| 6' x 10' | 77.00 |

COMPLETE 50 STATE FLAG SETS



OUTDOOR FLAGS

| ITEM # | SIZE | MATERIAL | PRICE | LBS. |
|--------|----------|----------|------------|------|
| 022048 | 2' x 3' | NYLON | \$1,440.00 | 13 |
| 022054 | 3' x 5' | NYLON | 2,290.00 | 24 |
| 022060 | 4' x 6' | NYLON | 4,300.00 | 36 |
| 022066 | 5' x 8' | NYLON | 6,310.00 | 52 |
| 022072 | 6' x 10' | NYLON | 10,250.00 | 86 |
| 022075 | 8' x 12' | NYLON | 19,000.00 | 147 |

INDOOR & PARADE FLAGS W/ POLE HEM

| ITEM # | SIZE | MATERIAL | PRICE | LBS. |
|--------|----------|----------|------------|------|
| 022049 | 2' x 3' | NYLON | \$2,260.00 | 11 |
| 022055 | 3' x 5' | NYLON | 3,340.00 | 21 |
| 022061 | 4' x 6' | NYLON | 5,450.00 | 33 |
| 022067 | 5' x 8' | NYLON | 7,740.00 | 47 |
| 022073 | 6' x 10' | NYLON | 12,150.00 | 79 |

INDOOR & PARADE FLAGS W/ POLE HEM & FRINGE

| ITEM # | SIZE | MATERIAL | PRICE | LBS. |
|--------|----------|----------|------------|------|
| 022050 | 2' x 3' | NYLON | \$3,090.00 | 16 |
| 022056 | 3' x 5' | NYLON | 4,390.00 | 39 |
| 022062 | 4' x 6' | NYLON | 6,600.00 | 48 |
| 022068 | 5' x 8' | NYLON | 9,260.00 | 62 |
| 022074 | 6' x 10' | NYLON | 14,100.00 | 97 |

4" x 6" MOUNTED E-GLOSS FLAGS



- Brilliantly printed on silk-like material.
- Hemmed on all four sides.
- Flags mounted on a 3/16" x 10" black plastic staff with gold spear.
- Highest quality mounted flag.
- **Ideal for desktop display.**

| SIZE | 1-11 DOZEN* | 12+ DOZEN* | LBS. |
|---------|-------------|------------|------|
| 4" x 6" | \$31.20 | \$28.08 | .36 |

*SOLD BY THE DOZEN

| STATE | ITEM # |
|-------------|--------|
| ALASKA | 020037 |
| CALIFORNIA | 020148 |
| CONNECTICUT | 020222 |
| FLORIDA | 020296 |
| HAWAII | 020370 |
| IDAHO | 020407 |
| INDIANA | 020481 |
| IOWA | 020518 |
| KANSAS | 020555 |

| STATE | ITEM # |
|---------------|--------|
| MASSACHUSETTS | 020740 |
| MICHIGAN | 020777 |
| MONTANA | 020925 |
| NEBRASKA | 020962 |
| NORTH DAKOTA | 021221 |
| RHODE ISLAND | 021406 |
| SOUTH DAKOTA | 021480 |
| VERMONT | 021633 |

Quantity discounts apply to the same flag & size.



| SPECS | | ALABAMA (A) | | ALASKA (A) | | ARIZONA (E) | | ARKANSAS (A) | | CALIFORNIA (A) | |
|-----------|----------|-------------|------|------------|------|-------------|------|--------------|------|----------------|------|
| SIZE | STYLE | ITEM # | LBS. | ITEM # | LBS. | ITEM # | LBS. | ITEM # | LBS. | ITEM # | LBS. |
| 12" x 18" | NYLON | 020004 | .10 | — | — | — | — | 020115 | .10 | — | — |
| 2' x 3' | NYLON | 020005 | .25 | 020042 | .25 | 020079 | .25 | 020116 | .25 | 020153 | .25 |
| 3' x 5' | NYLON | 020007 | .45 | 020044 | .45 | 020081 | .45 | 020118 | .45 | 020155 | .45 |
| 4' x 6' | NYLON | 020009 | .70 | 020046 | .70 | 020083 | .70 | 020120 | .70 | 020157 | .70 |
| 5' x 8' | NYLON | 020011 | 1.0 | 020048 | 1.0 | 020085 | 1.0 | 020122 | 1.0 | 020159 | 1.0 |
| 6' x 10' | NYLON | 020013 | 1.6 | 020050 | 1.8 | 020087 | 1.8 | 020124 | 1.7 | 020161 | 1.6 |
| 8' x 12' | NYLON | 020014 | 2.9 | 020051 | 3.0 | 020088 | 2.6 | 020125 | 2.9 | 020162 | 3.0 |
| 10' x 15' | NYLON | 022113 | 5.8 | 022114 | 4.8 | 022115 | 4.4 | 022116 | 4.7 | 022117 | 4.7 |
| 12' x 18' | NYLON | 020010 | 6.5 | 020052 | 6.8 | 020089 | 5.9 | 020126 | 6.6 | 020163 | 6.7 |
| 3' x 5' | POLY-MAX | 022197 | .65 | 022198 | .65 | 022199 | .65 | 022200 | .65 | 022201 | .65 |
| 4' x 6' | POLY-MAX | 022249 | .95 | 022250 | .95 | 022251 | .95 | 022252 | .95 | 022253 | .95 |
| 5' x 8' | POLY-MAX | 022301 | 3.2 | 022302 | 1.5 | 022303 | 1.5 | 022304 | 1.5 | 022305 | 1.5 |



| SPECS | | COLORADO (A) | | CONNECTICUT (C) | | DELAWARE (D) | | FLORIDA (D) | | GEORGIA (A) | |
|-----------|----------|--------------|------|-----------------|------|--------------|------|-------------|------|-------------|------|
| SIZE | STYLE | ITEM # | LBS. | ITEM # | LBS. | ITEM # | LBS. | ITEM # | LBS. | ITEM # | LBS. |
| 12" x 18" | NYLON | — | — | 020226 | .10 | 020263 | .10 | 020300 | .10 | 022173 | .10 |
| 2' x 3' | NYLON | 020190 | .25 | 020227 | .25 | 020264 | .25 | 020301 | .25 | 022174 | .25 |
| 3' x 5' | NYLON | 020192 | .45 | 020229 | .45 | 020266 | .45 | 020303 | .45 | 022176 | .45 |
| 4' x 6' | NYLON | 020194 | .70 | 020231 | .70 | 020268 | .70 | 020305 | .70 | 022177 | .70 |
| 5' x 8' | NYLON | 020196 | 1.0 | 020233 | 1.0 | 020270 | 1.0 | 020307 | 1.0 | 022178 | 1.0 |
| 6' x 10' | NYLON | 020198 | 2.7 | 020235 | 1.7 | 020272 | 1.7 | 020309 | 1.8 | 022179 | 1.7 |
| 8' x 12' | NYLON | 020199 | 4.1 | 020236 | 2.9 | 020273 | 2.9 | 020310 | 3.0 | 022180 | 2.9 |
| 10' x 15' | NYLON | 022118 | 5.8 | 022119 | 4.7 | 022120 | 4.6 | 022121 | 4.7 | 022196 | 4.4 |
| 12' x 18' | NYLON | 020200 | 9.2 | 020237 | 6.6 | 020274 | 6.5 | 020311 | 6.7 | — | — |
| 3' x 5' | POLY-MAX | 022202 | .65 | 022203 | .65 | 022204 | .65 | 022205 | .65 | 022206 | .65 |
| 4' x 6' | POLY-MAX | 022254 | .95 | 022255 | .95 | 022256 | .95 | 022257 | .95 | 022258 | .95 |
| 5' x 8' | POLY-MAX | 022306 | 1.5 | 022307 | 1.5 | 022308 | 1.5 | 022309 | 1.5 | 022310 | 1.5 |

STATE OUTDOOR FLAG PRICE CLASSIFICATIONS

| SIZE | STYLE | (A) STATES | | (B) OR, WA | | (C) STATES | | (D) STATES | | (E) STATES | |
|-----------|----------|------------|---------|------------|---------|------------|---------|------------|---------|------------|---------|
| | | 1-11 | 12+ | 1-11 | 12+ | 1-11 | 12+ | 1-11 | 12+ | 1-11 | 12+ |
| 12" x 18" | NYLON | \$14.50 | \$13.10 | \$14.50 | \$13.10 | \$14.50 | \$13.10 | \$14.50 | \$13.10 | \$14.50 | \$13.10 |
| 2' x 3' | NYLON | 31.50 | 28.30 | 47.10 | 42.40 | 31.50 | 28.30 | 31.50 | 28.30 | 31.50 | 28.30 |
| 3' x 5' | NYLON | 49.10 | 44.40 | 83.10 | 74.70 | 49.10 | 44.40 | 49.10 | 44.40 | 49.10 | 44.40 |
| 4' x 6' | NYLON | 82.00 | 79.00 | 118.00 | 112.50 | 89.50 | 85.00 | 97.50 | 92.50 | 97.50 | 92.50 |
| 5' x 8' | NYLON | 116.00 | 110.00 | 176.00 | 167.00 | 130.50 | 124.00 | 151.00 | 142.50 | 151.00 | 142.50 |
| 6' x 10' | NYLON | 208.00 | 186.00 | 271.00 | 246.00 | 219.00 | 196.00 | 243.00 | 219.00 | 389.00 | 351.00 |
| 8' x 12' | NYLON | 414.00 | 374.00 | 438.00 | 400.00 | 420.00 | 381.00 | 424.00 | 383.00 | 584.00 | 527.00 |
| 10' x 15' | NYLON | 515.00 | 489.00 | 612.00 | 580.00 | 529.00 | 504.00 | 607.00 | 568.00 | 680.00 | 637.00 |
| 12' x 18' | NYLON | 625.00 | 593.00 | 813.00 | 773.00 | 625.00 | 593.00 | 813.00 | 773.00 | 1252.00 | 1192.00 |
| 3' x 5' | POLY-MAX | 89.20 | 86.20 | 198.50 | 179.90 | 98.40 | 95.40 | 102.10 | 99.30 | 102.10 | 99.30 |
| 4' x 6' | POLY-MAX | 132.00 | 128.00 | 270.50 | 264.00 | 139.50 | 137.00 | 142.50 | 138.50 | 142.50 | 138.50 |
| 5' x 8' | POLY-MAX | 204.50 | 200.50 | 388.50 | 381.50 | 208.50 | 204.50 | 213.50 | 208.50 | 213.50 | 208.50 |



Quantity discounts apply to the same flag & size.

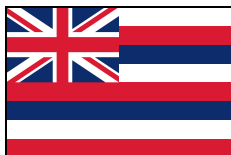

| HAWAII (A) | | | | IDAHO (D) | | ILLINOIS (D) | | INDIANA (A) | | IOWA (A) | |
|------------|----------|--------|------|-----------|------|--------------|------|-------------|------|----------|------|
| SIZE | STYLE | ITEM # | LBS. | ITEM # | LBS. | ITEM # | LBS. | ITEM # | LBS. | ITEM # | LBS. |
| 12" x 18" | NYLON | 020374 | .10 | 020411 | .10 | 020448 | .10 | 020485 | .10 | 020522 | .10 |
| 2' x 3' | NYLON | 020375 | .25 | 020412 | .25 | 020449 | .25 | 020486 | .25 | 020523 | .25 |
| 3' x 5' | NYLON | 020377 | .45 | 020414 | .45 | 020451 | .45 | 020488 | .45 | 020525 | .45 |
| 4' x 6' | NYLON | 020379 | .70 | 020416 | .70 | 020453 | .70 | 020490 | .70 | 020527 | .70 |
| 5' x 8' | NYLON | 020381 | 1.0 | 020418 | 1.0 | 020455 | 1.0 | 020492 | 1.0 | 020529 | 1.0 |
| 6' x 10' | NYLON | 020383 | 1.8 | 020420 | 1.7 | 020457 | 1.7 | 020494 | 1.6 | 020531 | 1.7 |
| 8' x 12' | NYLON | 020384 | 3.1 | 020421 | 2.7 | 020458 | 2.7 | 020495 | 2.8 | 020532 | 2.7 |
| 10' x 15' | NYLON | 022123 | 4.9 | 022124 | 4.5 | 022125 | 4.4 | 022126 | 4.5 | 022127 | 4.4 |
| 12' x 18' | NYLON | 020385 | 7.0 | 020422 | 6.1 | 020459 | 6.0 | 020496 | 6.2 | 020533 | 6.0 |
| 3' x 5' | POLY-MAX | 022207 | .65 | 022208 | .65 | 022209 | .65 | 022210 | .65 | 022211 | .65 |
| 4' x 6' | POLY-MAX | 022259 | .95 | 022260 | .95 | 022261 | .95 | 022262 | .95 | 022263 | .95 |
| 5' x 8' | POLY-MAX | 022311 | 1.5 | 022312 | 1.5 | 022313 | 1.5 | 022314 | 1.5 | 022315 | 1.5 |



| KANSAS (D) | | | | KENTUCKY (D) | | LOUISIANA (C) | | MAINE (D) | | MARYLAND (C) | |
|------------|----------|--------|------|--------------|------|---------------|------|-----------|------|--------------|------|
| SIZE | STYLE | ITEM # | LBS. | ITEM # | LBS. | ITEM # | LBS. | ITEM # | LBS. | ITEM # | LBS. |
| 12" x 18" | NYLON | 020559 | .10 | 020596 | .10 | 020633 | .10 | — | — | — | — |
| 2' x 3' | NYLON | 020560 | .25 | 020597 | .25 | 022424 | .25 | 020671 | .25 | 020708 | .25 |
| 3' x 5' | NYLON | 020562 | .45 | 020599 | .45 | 020636 | .45 | 020673 | .45 | 020710 | .45 |
| 4' x 6' | NYLON | 020564 | .70 | 020601 | .70 | 020638 | .70 | 020675 | .70 | 020712 | .70 |
| 5' x 8' | NYLON | 020566 | 1.0 | 020603 | 1.0 | 020640 | 1.0 | 020677 | 1.0 | 020714 | 1.0 |
| 6' x 10' | NYLON | 020568 | 1.7 | 020605 | 1.7 | 020642 | 1.7 | 020679 | 1.7 | 020716 | 1.8 |
| 8' x 12' | NYLON | 020569 | 3.1 | 020606 | 2.9 | 020643 | 3.0 | 020680 | 2.9 | 020717 | 3.0 |
| 10' x 15' | NYLON | 022128 | 4.8 | 022129 | 4.7 | 022130 | 4.7 | 022131 | 4.7 | — | — |
| 12' x 18' | NYLON | 020570 | 6.9 | 020607 | 6.6 | 020644 | 6.7 | 020681 | 6.6 | — | — |
| 3' x 5' | POLY-MAX | 022212 | .65 | 022213 | .65 | 022214 | .65 | 022215 | .65 | 022216 | .65 |
| 4' x 6' | POLY-MAX | 022264 | .95 | 022265 | .95 | 022266 | .95 | 022267 | .95 | 022268 | .95 |
| 5' x 8' | POLY-MAX | 022316 | 1.5 | 022317 | 1.5 | 022318 | 1.5 | 022319 | 1.5 | 022320 | 1.5 |



| MASSACHUSETTS (A) | | | | MICHIGAN (D) | | MINNESOTA (C) | | MISSISSIPPI (C) | | MISSOURI (C) | |
|-------------------|----------|--------|------|--------------|------|---------------|------|-----------------|------|--------------|------|
| SIZE | STYLE | ITEM # | LBS. | ITEM # | LBS. | ITEM # | LBS. | ITEM # | LBS. | ITEM # | LBS. |
| 12" x 18" | NYLON | 020744 | .10 | 020781 | .10 | 020818 | .10 | 020855 | .10 | 020892 | .10 |
| 2' x 3' | NYLON | 020745 | .25 | 020782 | .25 | 020819 | .25 | 020856 | .25 | 020893 | .25 |
| 3' x 5' | NYLON | 020747 | .45 | 020784 | .45 | 020821 | .45 | 020858 | .45 | 020895 | .45 |
| 4' x 6' | NYLON | 020749 | .70 | 020786 | .70 | 020823 | .70 | 020860 | .70 | 020897 | .70 |
| 5' x 8' | NYLON | 020751 | 1.0 | 020788 | 1.0 | 020825 | 1.0 | 020862 | 1.0 | 020899 | 1.0 |
| 6' x 10' | NYLON | 020753 | 1.7 | 020790 | 1.6 | 020827 | 1.6 | 020864 | 1.7 | 020901 | 1.7 |
| 8' x 12' | NYLON | 020754 | 2.9 | 020791 | 2.9 | 020828 | 2.9 | 020865 | 3.8 | 020902 | 3.0 |
| 10' x 15' | NYLON | 022132 | 4.7 | 022133 | 4.7 | 022134 | 4.7 | 022135 | 5.6 | 022136 | 4.7 |
| 12' x 18' | NYLON | 020755 | 6.6 | 020792 | 6.6 | 020829 | 6.6 | — | — | 020903 | 6.7 |
| 3' x 5' | POLY-MAX | 022217 | .65 | 022218 | .65 | 022219 | .65 | 022220 | .65 | 022221 | .65 |
| 4' x 6' | POLY-MAX | 022269 | .95 | 022270 | .95 | 022271 | .95 | 022272 | .95 | 022273 | .95 |
| 5' x 8' | POLY-MAX | 022321 | 1.5 | 022322 | 1.5 | 022323 | 1.5 | 022324 | 1.5 | 022325 | 1.5 |

Quantity discounts apply to the same flag & size.

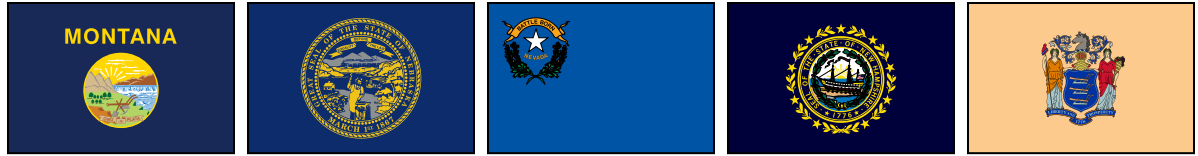

| SPECS | | MONTANA (D) | | NEBRASKA (A) | | NEVADA (A) | | NEW HAMPSHIRE (D) | | NEW JERSEY (D) | |
|-----------|----------|-------------|------|--------------|------|------------|------|-------------------|------|----------------|------|
| SIZE | STYLE | ITEM # | LBS. | ITEM # | LBS. | ITEM # | LBS. | ITEM # | LBS. | ITEM # | LBS. |
| 12" x 18" | NYLON | 020929 | .10 | 020966 | .10 | 021003 | .10 | 021040 | .10 | 021077 | .10 |
| 2' x 3' | NYLON | 020930 | .25 | 020967 | .25 | 021004 | .25 | 021041 | .25 | 021078 | .25 |
| 3' x 5' | NYLON | 020932 | .45 | 020969 | .45 | 021006 | .45 | 021043 | .45 | 021080 | .45 |
| 4' x 6' | NYLON | 020934 | .70 | 020971 | .70 | 021008 | .70 | 021045 | .70 | 021082 | .70 |
| 5' x 8' | NYLON | 020936 | 1.0 | 020973 | 1.0 | 021010 | 1.0 | 021047 | 1.0 | 021084 | 1.0 |
| 6' x 10' | NYLON | 020938 | 1.9 | 020975 | 1.8 | 021012 | 1.7 | 021049 | 1.5 | 021086 | 1.7 |
| 8' x 12' | NYLON | 020939 | 3.2 | 020976 | 3.2 | 021013 | 2.9 | 021050 | 3.0 | 021087 | 3.0 |
| 10' x 15' | NYLON | 022137 | 5.0 | 022138 | 5.0 | 022139 | 4.6 | 022140 | 4.7 | 022141 | 4.7 |
| 12' x 18' | NYLON | 020940 | 7.2 | 020977 | 7.2 | 021014 | 6.5 | 021051 | 6.7 | 021088 | 6.7 |
| 3' x 5' | POLY-MAX | 022222 | .65 | 022223 | .65 | 022224 | .65 | 022225 | .65 | 022226 | .65 |
| 4' x 6' | POLY-MAX | 022274 | .95 | 022275 | .95 | 022276 | .95 | 022277 | .95 | 022278 | .95 |
| 5' x 8' | POLY-MAX | 022326 | 1.5 | 022327 | 1.5 | 022328 | 1.5 | 022329 | 1.5 | 022330 | 1.5 |



| SPECS | | NEW MEXICO (A) | | NEW YORK (D) | | NORTH CAROLINA (A) | | NORTH DAKOTA (C) | | OHIO (A) | |
|-----------|----------|----------------|------|--------------|------|--------------------|------|------------------|------|----------|------|
| SIZE | STYLE | ITEM # | LBS. | ITEM # | LBS. | ITEM # | LBS. | ITEM # | LBS. | ITEM # | LBS. |
| 12" x 18" | NYLON | 021114 | .10 | 021151 | .10 | 021188 | .10 | — | — | 021262 | .10 |
| 2' x 3' | NYLON | 021115 | .25 | 021152 | .25 | 021189 | .25 | 021226 | .25 | 021263 | .25 |
| 3' x 5' | NYLON | 021117 | .45 | 021154 | .45 | 021191 | .45 | 021228 | .45 | 021265 | .45 |
| 4' x 6' | NYLON | 021119 | .70 | 021156 | .70 | 021193 | .70 | 021230 | .70 | 021267 | .70 |
| 5' x 8' | NYLON | 021121 | 1.0 | 021158 | 1.0 | 021195 | 1.0 | 021232 | 1.0 | 021269 | 1.0 |
| 6' x 10' | NYLON | 021123 | 1.8 | 021160 | 1.8 | 021197 | 1.5 | 021234 | 1.8 | 021271 | 1.8 |
| 8' x 12' | NYLON | 021124 | 3.1 | 021161 | 2.9 | 021198 | 2.7 | 021235 | 2.7 | 021272 | 2.7 |
| 10' x 15' | NYLON | 022142 | 4.9 | 022143 | 4.7 | 022144 | 4.5 | 022145 | 4.4 | 022146 | 4.4 |
| 12' x 18' | NYLON | 021125 | 7.0 | 021162 | 6.6 | 021199 | 6.1 | 021236 | 6.0 | — | — |
| 3' x 5' | POLY-MAX | 022227 | .65 | 022228 | .65 | 022229 | .65 | 022230 | .65 | 022231 | .65 |
| 4' x 6' | POLY-MAX | 022279 | .95 | 022280 | .95 | 022281 | .95 | 022282 | .95 | 022283 | .95 |
| 5' x 8' | POLY-MAX | 022331 | 1.5 | 022332 | 1.5 | 022333 | 1.5 | 022334 | 1.5 | 022335 | 1.5 |

STATE OUTDOOR FLAG PRICE CLASSIFICATIONS

| SIZE | STYLE | (A) STATES | | (B) OR, WA | | (C) STATES | | (D) STATES | | (E) STATES | |
|-----------|----------|------------|---------|------------|---------|------------|---------|------------|---------|------------|---------|
| | | 1-11 | 12+ | 1-11 | 12+ | 1-11 | 12+ | 1-11 | 12+ | 1-11 | 12+ |
| 12" x 18" | NYLON | \$14.50 | \$13.10 | \$14.50 | \$13.10 | \$14.50 | \$13.10 | \$14.50 | \$13.10 | \$14.50 | \$13.10 |
| 2' x 3' | NYLON | 31.50 | 28.30 | 47.10 | 42.40 | 31.50 | 28.30 | 31.50 | 28.30 | 31.50 | 28.30 |
| 3' x 5' | NYLON | 49.10 | 44.40 | 83.10 | 74.70 | 49.10 | 44.40 | 49.10 | 44.40 | 49.10 | 44.40 |
| 4' x 6' | NYLON | 82.00 | 79.00 | 118.00 | 112.50 | 89.50 | 85.00 | 97.50 | 92.50 | 97.50 | 92.50 |
| 5' x 8' | NYLON | 116.00 | 110.00 | 176.00 | 167.00 | 130.50 | 124.00 | 151.00 | 142.50 | 151.00 | 142.50 |
| 6' x 10' | NYLON | 208.00 | 186.00 | 271.00 | 246.00 | 219.00 | 196.00 | 243.00 | 219.00 | 389.00 | 351.00 |
| 8' x 12' | NYLON | 414.00 | 374.00 | 438.00 | 400.00 | 420.00 | 381.00 | 424.00 | 383.00 | 584.00 | 527.00 |
| 10' x 15' | NYLON | 515.00 | 489.00 | 612.00 | 580.00 | 529.00 | 504.00 | 607.00 | 568.00 | 680.00 | 637.00 |
| 12' x 18' | NYLON | 625.00 | 593.00 | 813.00 | 773.00 | 625.00 | 593.00 | 813.00 | 773.00 | 1252.00 | 1192.00 |
| 3' x 5' | POLY-MAX | 89.20 | 86.20 | 198.50 | 179.90 | 98.40 | 95.40 | 102.10 | 99.30 | 102.10 | 99.30 |
| 4' x 6' | POLY-MAX | 132.00 | 128.00 | 270.50 | 264.00 | 139.50 | 137.00 | 142.50 | 138.50 | 142.50 | 138.50 |
| 5' x 8' | POLY-MAX | 204.50 | 200.50 | 388.50 | 381.50 | 208.50 | 204.50 | 213.50 | 208.50 | 213.50 | 208.50 |



Quantity discounts apply to the same flag & size.



| OKLAHOMA (C) | | | | OREGON (B) | | PENNSYLVANIA (D) | | RHODE ISLAND (A) | | SOUTH CAROLINA (A) | |
|--------------|----------|--------|------|------------|------|------------------|------|------------------|------|--------------------|------|
| SIZE | STYLE | ITEM # | LBS. | ITEM # | LBS. | ITEM # | LBS. | ITEM # | LBS. | ITEM # | LBS. |
| 12" x 18" | NYLON | 021299 | .10 | — | — | 021373 | .10 | 021410 | .10 | 021447 | .10 |
| 2' x 3' | NYLON | 021300 | .25 | 021337 | .30 | 021374 | .25 | 021411 | .25 | 021448 | .25 |
| 3' x 5' | NYLON | 021302 | .45 | 021339 | .60 | 021376 | .45 | 021413 | .45 | 021450 | .45 |
| 4' x 6' | NYLON | 021304 | .70 | 021341 | 1.0 | 021378 | .70 | 021415 | .70 | 021452 | .70 |
| 5' x 8' | NYLON | 021306 | 1.0 | 021343 | 1.4 | 021380 | 1.0 | 021417 | 1.0 | 021454 | 1.0 |
| 6' x 10' | NYLON | 021308 | 1.6 | 021345 | 2.1 | 021382 | 1.7 | 021419 | 1.7 | 021456 | 1.7 |
| 8' x 12' | NYLON | 021309 | 3.0 | 021346 | 3.2 | 021383 | 2.6 | 021420 | 2.9 | 021457 | 2.8 |
| 10' x 15' | NYLON | 022147 | 4.8 | 022148 | 4.9 | 022149 | 4.4 | 022150 | 4.7 | 022151 | 4.6 |
| 12' x 18' | NYLON | 021310 | 6.8 | 021347 | 7.1 | 021384 | 5.9 | 021421 | 6.6 | 021458 | 6.3 |
| 3' x 5' | POLY-MAX | 022232 | .65 | 022233 | .95 | 022234 | .65 | 022235 | .65 | 022236 | .65 |
| 4' x 6' | POLY-MAX | 022284 | .95 | 022285 | 1.4 | 022286 | .95 | 022287 | .95 | 022288 | .95 |
| 5' x 8' | POLY-MAX | 022336 | 1.5 | 022337 | 2.3 | 022338 | 1.5 | 022339 | 1.5 | 022340 | 1.5 |

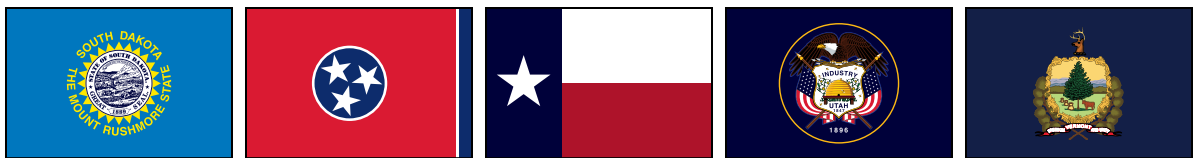

| SOUTH DAKOTA (C) | | | | TENNESSEE (A) | | TEXAS (TX) | | UTAH* (D) | | VERMONT (D) | |
|------------------|----------|--------|------|---------------|------|-------------------------------|--------|-----------|--------|-------------|------|
| SIZE | STYLE | ITEM # | LBS. | ITEM # | LBS. | ITEM # | LBS. | ITEM # | LBS. | ITEM # | LBS. |
| 12" x 18" | NYLON | 021484 | .10 | 021521 | .10 | SEE NEXT PAGE FOR TEXAS FLAGS | — | — | — | 021637 | .10 |
| 2' x 3' | NYLON | 021485 | .25 | 021522 | .25 | | 021601 | .25 | 021638 | .25 | |
| 3' x 5' | NYLON | 021487 | .45 | 021524 | .45 | | 021603 | .45 | 021640 | .45 | |
| 4' x 6' | NYLON | 021489 | .70 | 021526 | .70 | | 021605 | .70 | 021642 | .70 | |
| 5' x 8' | NYLON | 021491 | 1.0 | 021528 | 1.0 | | 021607 | 1.0 | 021644 | 1.0 | |
| 6' x 10' | NYLON | 021493 | 1.7 | 021530 | 2.3 | | 021609 | 1.7 | 021646 | 1.8 | |
| 8' x 12' | NYLON | 021494 | 2.9 | 021531 | 3.0 | | 021610 | 2.7 | 021647 | 2.9 | |
| 10' x 15' | NYLON | 022152 | 4.6 | 022153 | 4.8 | | 022155 | 4.4 | 022156 | 4.7 | |
| 12' x 18' | NYLON | 021495 | 6.5 | 021532 | 6.8 | | 021611 | 6.0 | 021648 | 6.6 | |
| 3' x 5' | POLY-MAX | 022237 | .65 | 022238 | .65 | | 022240 | .65 | 022241 | .65 | |
| 4' x 6' | POLY-MAX | 022289 | .95 | 022290 | .95 | | 022292 | .95 | 022293 | .95 | |
| 5' x 8' | POLY-MAX | 022341 | 1.5 | 022342 | 1.5 | | 022344 | 1.5 | 022345 | 1.5 | |

* 2023 Utah flag design is available. Email sales at sales@ederflag.com or call 1-800-558-6044 for ordering information.



| VIRGINIA (D) | | | | WASHINGTON (B) | | WEST VIRGINIA (D) | | WISCONSIN (D) | | WYOMING (A) | |
|--------------|----------|--------|------|----------------|------|-------------------|------|---------------|------|-------------|------|
| SIZE | STYLE | ITEM # | LBS. | ITEM # | LBS. | ITEM # | LBS. | ITEM # | LBS. | ITEM # | LBS. |
| 12" x 18" | NYLON | 021674 | .10 | — | — | 021748 | .10 | 021785 | .10 | 021822 | .10 |
| 2' x 3' | NYLON | 021675 | .25 | 021712 | .30 | 021749 | .25 | 021786 | .25 | 021823 | .25 |
| 3' x 5' | NYLON | 021677 | .45 | 021714 | .55 | 021751 | .45 | 021788 | .45 | 021825 | .45 |
| 4' x 6' | NYLON | 021679 | .70 | 021716 | .80 | 021753 | .70 | 021790 | .70 | 021827 | .70 |
| 5' x 8' | NYLON | 021681 | 1.0 | 021718 | 1.3 | 021755 | 1.0 | 021792 | 1.0 | 021829 | 1.0 |
| 6' x 10' | NYLON | 021683 | 1.6 | 021720 | 1.9 | 021757 | 1.7 | 021794 | 1.7 | 021831 | 1.7 |
| 8' x 12' | NYLON | 021684 | 2.8 | 021721 | 3.5 | 021758 | 3.2 | 021795 | 3.2 | 021832 | 3.0 |
| 10' x 15' | NYLON | 022157 | 4.5 | 022158 | 5.3 | 022159 | 4.9 | 022077 | 4.5 | 022160 | 4.9 |
| 12' x 18' | NYLON | 021685 | 6.2 | 021722 | 7.9 | 021759 | 7.1 | 021796 | 7.1 | 021833 | 6.8 |
| 3' x 5' | POLY-MAX | 022242 | .65 | 022243 | .95 | 022244 | .65 | 022245 | .65 | 022246 | .65 |
| 4' x 6' | POLY-MAX | 022294 | .95 | 022295 | 1.4 | 022296 | .95 | 022297 | .95 | 022298 | .95 |
| 5' x 8' | POLY-MAX | 022346 | 1.5 | 022347 | 2.3 | 022348 | 1.5 | 022349 | 1.5 | 022350 | 1.5 |

Quantity discounts apply to the same flag & size.

TEXAS FLAGS

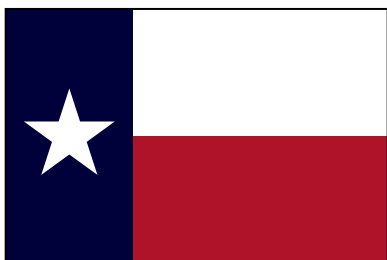

MOUNTED

| ITEM # | SIZE | MATERIAL | 1-143 | 144+ | LBS. |
|--------|-----------|----------|--------|--------|------|
| 021554 | 4" x 6" | PLASTIC | \$0.58 | \$0.50 | .02 |
| 021556 | 8" x 12" | PLASTIC | 1.22 | 1.14 | .05 |
| 021558 | 12" x 18" | PLASTIC | 2.26 | 1.88 | .10 |

♦SOLD BY THE DOZEN

FULLY PRINTED OUTDOOR

| ITEM # | SIZE | MATERIAL | 1-11 | 12+ | LBS. |
|--------|-----------|-------------|---------|---------|------|
| 021561 | 12" x 18" | NYLON | \$14.50 | \$13.10 | .10 |
| 021564 | 3' x 5' | NYLON | 49.20 | 44.40 | .45 |
| 021563 | 3' x 5' | POLY-COTTON | 23.50 | 21.50 | .35 |

FULLY SEWN OUTDOOR NYLON

| ITEM # | SIZE | 1-11 | 12+ | LBS. |
|--------|-----------|----------|----------|------|
| 021562 | 2' x 3' | \$23.90 | \$21.10 | .35 |
| 021565 | 3' x 5' | 37.70 | 34.50 | .75 |
| 021567 | 4' x 6' | 51.50 | 49.50 | 1.1 |
| 021569 | 5' x 8' | 73.50 | 71.00 | 1.8 |
| 021571 | 6' x 10' | 166.00 | 159.00 | 2.1 |
| 021572 | 8' x 12' | 248.00 | 241.00 | 3.0 |
| 022076 | 10' x 15' | 318.00 | 304.00 | 4.4 |
| 022418 | 10' x 19' | 379.00 | 375.00 | 5.5 |
| 021573 | 12' x 18' | 432.00 | 422.00 | 6.5 |
| 022356 | 15' x 25' | 652.00 | 618.00 | 11 |
| 022415 | 20' x 30' | 912.00 | 856.00 | 17 |
| 022357 | 20' x 38' | 1,250.00 | 1,183.00 | 20 |
| 022420 | 30' x 50' | 2,400.00 | 2,380.00 | 43 |
| 022422 | 30' x 60' | 2,990.00 | 2,830.00 | 52 |

FULLY SEWN OUTDOOR POLY-MAX

| ITEM # | SIZE | 1-11 | 12+ | LBS. |
|--------|-----------|----------|----------|------|
| 022417 | 2' x 3' | \$42.40 | \$39.40 | .50 |
| 022239 | 3' x 5' | 54.00 | 52.60 | .75 |
| 022291 | 4' x 6' | 76.00 | 73.00 | .95 |
| 022343 | 5' x 8' | 97.50 | 95.50 | 1.7 |
| 022358 | 6' x 10' | 208.00 | 205.00 | 3.2 |
| 022359 | 8' x 12' | 284.00 | 282.00 | 5.1 |
| 022360 | 10' x 15' | 397.00 | 394.00 | 8.0 |
| 022419 | 10' x 19' | 516.00 | 493.00 | 9.0 |
| 022361 | 12' x 18' | 650.00 | 623.00 | 11 |
| 022362 | 15' x 25' | 910.00 | 880.00 | 18 |
| 022416 | 20' x 30' | 1,510.00 | 1,470.00 | 34 |
| 022363 | 20' x 38' | 1,690.00 | 1,660.00 | 38 |
| 022421 | 30' x 50' | 2,950.00 | 2,890.00 | 85 |
| 022423 | 30' x 60' | 3,620.00 | 3,590.00 | 103 |

TERRITORY 4" x 6" MOUNTED E-GLOSS FLAGS



- Brilliantly printed on silk-like material.
- Hemmed on all four sides.
- Flags mounted on a 3/16" x 10" black plastic staff with gold spear.
- Highest quality mounted flag.
- **Ideal for desktop display.**

| TERRITORY | ITEM # |
|-------------------|--------|
| AMERICAN SAMOA | 021855 |
| NORTHERN MARIANAS | 022022 |

| SIZE | 1-11 DOZEN* | 12+ DOZEN* | LBS. |
|---------|-------------|------------|------|
| 4" x 6" | \$31.20 | \$28.08 | .36 |

♦SOLD BY THE DOZEN

Quantity discounts apply to the same flag & size.

TERRITORY OUTDOOR NYLON FLAGS



| SPECS | | AMERICAN SAMOA (C) | | DISTRICT OF COLUMBIA (A) | | GUAM (D) | |
|-----------|----------|--------------------|------|--------------------------|------|----------|------|
| SIZE | STYLE | ITEM # | LBS. | ITEM # | LBS. | ITEM # | LBS. |
| 12" x 18" | NYLON | — | — | 021882 | .10 | 021918 | .10 |
| 2' x 3' | NYLON | — | — | 021883 | .25 | 021919 | .25 |
| 3' x 5' | NYLON | 021857 | .45 | 021885 | .45 | 021921 | .45 |
| 4' x 6' | NYLON | 021859 | .70 | 021887 | .70 | 021923 | .70 |
| 5' x 8' | NYLON | 021861 | 1.0 | 021889 | 1.0 | 021925 | 1.0 |
| 6' x 10' | NYLON | — | — | 021891 | 1.8 | 021927 | 1.8 |
| 8' x 12' | NYLON | — | — | 021892 | 3.1 | 021928 | 2.9 |
| 10' x 15' | NYLON | — | — | 022161 | 4.8 | — | — |
| 3' x 5' | POLY-MAX | — | — | 022247 | .65 | — | — |
| 4' x 6' | POLY-MAX | — | — | 022299 | .95 | — | — |
| 5' x 8' | POLY-MAX | — | — | 022351 | 1.5 | — | — |
| 3' x 5' | E-POLY | — | — | — | — | — | — |



| SPECS | | NORTHERN MARIANAS (D) | | PUERTO RICO (A) | | VIRGIN ISLANDS (B) | |
|-----------|----------|-----------------------|------|-----------------|------|--------------------|------|
| SIZE | STYLE | ITEM # | LBS. | ITEM # | LBS. | ITEM # | LBS. |
| 12" x 18" | NYLON | — | — | 021954 | .10 | — | — |
| 2' x 3' | NYLON | — | — | 021955 | .25 | 021991 | .25 |
| 3' x 5' | NYLON | 022024 | .45 | 021957 | .45 | 021993 | .45 |
| 4' x 6' | NYLON | 022026 | .70 | 021959 | .70 | 021995 | .70 |
| 5' x 8' | NYLON | 035829 | 1.0 | 021961 | 1.0 | 021997 | 1.0 |
| 6' x 10' | NYLON | — | — | 021963 | 1.7 | 021999 | 1.8 |
| 8' x 12' | NYLON | — | — | 021964 | 3.2 | 022000 | 2.7 |
| 10' x 15' | NYLON | — | — | 022163 | 4.9 | — | — |
| 3' x 5' | POLY-MAX | — | — | 022248 | .65 | — | — |
| 4' x 6' | POLY-MAX | — | — | 022300 | .95 | — | — |
| 5' x 8' | POLY-MAX | — | — | 022352 | 1.5 | — | — |
| 3' x 5' | E-POLY | — | — | 021956 | .35 | — | — |

| TERRITORY OUTDOOR FLAG PRICE CLASSIFICATIONS | | | | | | | | | |
|--|----------|----------------|---------|----------|---------|----------|--------|----------------|---------|
| SIZE | STYLE | (A) D.C., P.R. | | (B) V.I. | | (C) A.S. | | (D) GUAM, N.M. | |
| | | 1-11 | 12+ | 1-11 | 12+ | 1-11 | 12+ | 1-11 | 12+ |
| 12" x 18" | NYLON | \$14.50 | \$13.10 | \$14.50 | \$13.10 | — | — | \$14.50 | \$13.10 |
| 2' x 3' | NYLON | 31.50 | 28.30 | 31.50 | 28.30 | — | — | 64.20 | 57.80 |
| 3' x 5' | NYLON | 57.20 | 51.50 | 57.20 | 51.50 | 57.20 | 51.50 | 57.20 | 51.50 |
| 4' x 6' | NYLON | 82.00 | 79.00 | 97.50 | 92.50 | 97.50 | 92.50 | 97.50 | 92.50 |
| 5' x 8' | NYLON | 116.00 | 110.00 | 116.00 | 110.00 | 142.50 | 129.00 | 186.00 | 168.00 |
| 6' x 10' | NYLON | 208.00 | 186.00 | 215.00 | 193.00 | — | — | 243.00 | 219.00 |
| 8' x 12' | NYLON | 414.00 | 374.00 | 414.00 | 374.00 | — | — | 424.00 | 383.00 |
| 10' x 15' | NYLON | 515.00 | 489.00 | — | — | — | — | — | — |
| 3' x 5' | POLY-MAX | 85.90 | 83.00 | — | — | — | — | — | — |
| 4' x 6' | POLY-MAX | 127.00 | 123.00 | — | — | — | — | — | — |
| 5' x 8' | POLY-MAX | 166.00 | 162.00 | — | — | — | — | — | — |
| 3' x 5' | E-POLY | 30.00 | 26.50 | — | — | — | — | — | — |

Quantity discounts apply to the same flag & size.

COMPLETE WORLD ORGANIZATION FLAG SETS



35 MEMBER COMPLETE O.A.S. SETS



OUTDOOR FLAGS

| ITEM # | SIZE | MATERIAL | DESCRIPTION | PRICE | LBS. |
|--------|---------|----------|-------------|-------------------|------|
| 034648 | 2' x 3' | NYLON | OUTDOOR | \$1,460.00 | 8.8 |
| 034654 | 3' x 5' | NYLON | OUTDOOR | 2,160.00 | 16 |
| 034657 | 4' x 6' | NYLON | OUTDOOR | 3,090.00 | 25 |
| 034660 | 5' x 8' | NYLON | OUTDOOR | 4,540.00 | 32 |

INDOOR / PARADE FLAGS W/POLE HEM

| ITEM # | SIZE | MATERIAL | DESCRIPTION | PRICE | LBS. |
|--------|---------|----------|-------------|-------------------|------|
| 034649 | 2' x 3' | NYLON | w/POLE HEM | \$2,050.00 | 7.1 |
| 034655 | 3' x 5' | NYLON | w/POLE HEM | 2,890.00 | 15 |
| 034658 | 4' x 6' | NYLON | w/POLE HEM | 3,900.00 | 23 |
| 034661 | 5' x 8' | NYLON | w/POLE HEM | 5,590.00 | 29 |

INDOOR / PARADE FLAGS W/POLE HEM & FRINGE

| ITEM # | SIZE | MATERIAL | DESCRIPTION | PRICE | LBS. |
|--------|---------|----------|-------------|-------------------|------|
| 034650 | 2' x 3' | NYLON | w/PH & FR | \$2,630.00 | 11 |
| 034656 | 3' x 5' | NYLON | w/PH & FR | 3,630.00 | 22 |
| 034659 | 4' x 6' | NYLON | w/PH & FR | 4,730.00 | 34 |
| 034662 | 5' x 8' | NYLON | w/PH & FR | 6,660.00 | 39 |

193 MEMBER COMPLETE U.N. SETS



OUTDOOR FLAGS

| ITEM # | SIZE | MATERIAL | DESCRIPTION | PRICE | LBS. |
|--------|---------|----------|-------------|-------------------|------|
| 034632 | 2' x 3' | NYLON | OUTDOOR | \$7,190.00 | 48 |
| 034635 | 3' x 5' | NYLON | OUTDOOR | 10,670.00 | 86 |
| 034638 | 4' x 6' | NYLON | OUTDOOR | 15,390.00 | 133 |
| 034641 | 5' x 8' | NYLON | OUTDOOR | 23,020.00 | 171 |

INDOOR / PARADE FLAGS W/POLE HEM

| ITEM # | SIZE | MATERIAL | DESCRIPTION | PRICE | LBS. |
|--------|---------|----------|-------------|--------------------|------|
| 034633 | 2' x 3' | NYLON | w/POLE HEM | \$10,390.00 | 38 |
| 034636 | 3' x 5' | NYLON | w/POLE HEM | 14,720.00 | 76 |
| 034639 | 4' x 6' | NYLON | w/POLE HEM | 19,830.00 | 123 |
| 034642 | 5' x 8' | NYLON | w/POLE HEM | 28,580.00 | 152 |

INDOOR / PARADE FLAGS W/POLE HEM & FRINGE

| ITEM # | SIZE | MATERIAL | DESCRIPTION | PRICE | LBS. |
|--------|---------|----------|-------------|--------------------|------|
| 034634 | 2' x 3' | NYLON | w/PH & FR | \$13,580.00 | 57 |
| 034637 | 3' x 5' | NYLON | w/PH & FR | 18,770.00 | 114 |
| 034640 | 4' x 6' | NYLON | w/PH & FR | 24,290.00 | 180 |
| 034643 | 5' x 8' | NYLON | w/PH & FR | 34,460.00 | 209 |

Quantity discounts apply to the same flag & size.



| SPECS | | ACADIANA (F) | | AFGHANISTAN (UN) (D) | | AFRO-AMERICAN (A) | | ÅLAND ISLANDS (F) | | ALBANIA (UN) (D) | |
|-----------|--------|--------------|------|----------------------|------|-------------------|------|-------------------|------|------------------|------|
| SIZE | STYLE | ITEM # | LBS. | ITEM # | LBS. | ITEM # | LBS. | ITEM # | LBS. | ITEM # | LBS. |
| 12" x 18" | NYLON | — | — | — | — | 030041 | .10 | — | — | — | — |
| 2' x 3' | NYLON | — | — | 030024 | .25 | 030042 | .25 | — | — | 030062 | .25 |
| 3' x 5' | NYLON | — | — | 030026 | .45 | 030044 | .45 | 030058 | .45 | 030064 | .45 |
| 4' x 6' | NYLON | — | — | 030027 | .70 | 030045 | .70 | — | — | 030065 | .70 |
| 5' x 8' | NYLON | — | — | 030028 | 1.0 | 030046 | 1.0 | — | — | 030066 | 1.0 |
| 6' x 10' | NYLON | — | — | 035002 | 1.8 | 035003 | 1.8 | — | — | 035004 | 1.8 |
| 3' x 5' | E-POLY | 030017 | .27 | — | — | — | — | — | — | — | — |

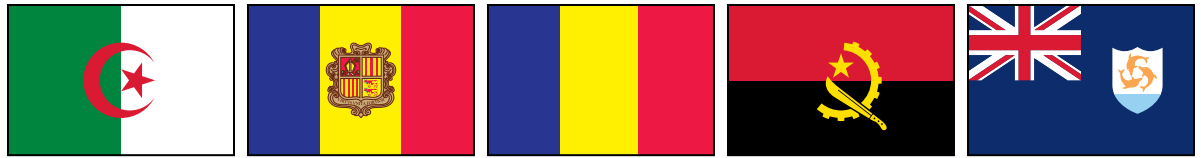

| SPECS | | ALGERIA (UN) (D) | | ANDORRA w/SEAL (UN) (F) | | ANDORRA (NO SEAL) (A) | | ANGOLA (UN) (D) | | ANGUILLA (E) | |
|-----------|-------|------------------|------|-------------------------|------|-----------------------|------|-----------------|------|--------------|------|
| SIZE | STYLE | ITEM # | LBS. | ITEM # | LBS. | ITEM # | LBS. | ITEM # | LBS. | ITEM # | LBS. |
| 12" x 18" | NYLON | — | — | — | — | — | — | — | — | 035753 | .10 |
| 2' x 3' | NYLON | 030079 | .25 | 030096 | .25 | 030113 | .25 | 030126 | .25 | 030143 | .25 |
| 3' x 5' | NYLON | 030081 | .45 | 030098 | .45 | 030114 | .45 | 030128 | .45 | 030145 | .45 |
| 4' x 6' | NYLON | 030082 | .70 | 030099 | .70 | 030115 | .70 | 030129 | .70 | 030146 | .70 |
| 5' x 8' | NYLON | 030083 | 1.0 | 030100 | 1.0 | 030116 | 1.0 | 030130 | 1.0 | 030147 | 1.0 |
| 6' x 10' | NYLON | 035005 | 1.8 | 035007 | 1.8 | 035006 | 1.8 | 035008 | 1.8 | — | — |



| SPECS | | ANTIGUA & BARBUDA (UN/OAS) (E) | | ARGENTINA w/SEAL (UN/OAS) (C) | | ARGENTINA (NO SEAL) (A) | | ARMENIA (UN) (A) | | ARUBA (D) | |
|-----------|--------|--------------------------------|------|-------------------------------|------|-------------------------|------|------------------|------|-----------|------|
| SIZE | STYLE | ITEM # | LBS. | ITEM # | LBS. | ITEM # | LBS. | ITEM # | LBS. | ITEM # | LBS. |
| 12" x 18" | NYLON | 035754 | .10 | — | — | 030206 | .10 | — | — | 030244 | .10 |
| 2' x 3' | NYLON | 030164 | .25 | 030188 | .25 | 030207 | .25 | 030223 | .25 | 030245 | .25 |
| 3' x 5' | NYLON | 030166 | .45 | 030190 | .45 | 030208 | .45 | 030225 | .45 | 030247 | .45 |
| 4' x 6' | NYLON | 030167 | .70 | 030191 | .70 | 030209 | .70 | 030226 | .70 | 030248 | .70 |
| 5' x 8' | NYLON | 030168 | 1.0 | 030192 | 1.0 | 030210 | 1.0 | 030227 | 1.0 | 030249 | 1.0 |
| 6' x 10' | NYLON | 035010 | 1.8 | 035012 | 1.8 | 035011 | 1.8 | 035013 | 1.8 | 035014 | 1.8 |
| 3' x 5' | E-POLY | — | — | 030189 | .27 | — | — | — | — | — | — |

WORLD OUTDOOR FLAG PRICE CLASSIFICATIONS

| SIZE | STYLE | (A) WORLD | | (B) WORLD | | (C) WORLD | | (D) WORLD | | (E) WORLD | | (F) WORLD | |
|-----------|--------|-----------|---------|-----------|---------|-----------|---------|-----------|---------|-----------|---------|-----------|---------|
| | | 1-5 | 6+ | 1-5 | 6+ | 1-5 | 6+ | 1-5 | 6+ | 1-5 | 6+ | 1-5 | 6+ |
| 12" x 18" | NYLON | \$16.10 | \$14.40 | \$17.00 | \$15.60 | \$18.80 | \$17.00 | \$20.70 | \$18.60 | \$20.70 | \$18.60 | \$20.70 | \$18.60 |
| 2' x 3' | NYLON | 27.00 | 24.60 | 33.80 | 30.10 | 39.20 | 35.50 | 44.20 | 39.90 | 47.20 | 41.60 | 60.00 | 53.90 |
| 3' x 5' | NYLON | 36.50 | 32.50 | 54.00 | 49.00 | 62.00 | 55.00 | 63.00 | 57.00 | 72.50 | 65.50 | 83.00 | 74.00 |
| 4' x 6' | NYLON | 50.00 | 44.50 | 85.50 | 77.50 | 90.00 | 81.00 | 93.50 | 85.00 | 103.00 | 92.50 | 115.00 | 103.00 |
| 5' x 8' | NYLON | 78.00 | 75.00 | 112.00 | 108.00 | 126.00 | 121.00 | 128.00 | 122.00 | 147.00 | 142.00 | 156.00 | 146.00 |
| 6' x 10' | NYLON | 126.00 | — | 206.00 | — | 232.00 | — | 252.00 | — | 289.00 | — | 323.00 | — |
| 3' x 5' | E-POLY | 30.00 | 26.50 | 30.00 | 26.50 | 30.00 | 26.50 | 30.00 | 26.50 | 30.00 | 26.50 | 30.00 | 26.50 |

Quantity discounts apply to the same flag & size.



| SPECS | | AUSTRALIA (UN) (B) | | AUSTRIA NO EAGLE (UN) (A) | | AUSTRIA w/EAGLE (F) | | AZERBAIJAN (UN) (E) | | AZORES (F) | |
|----------|--------|-----------------------|------|---------------------------------|------|------------------------|------|------------------------|------|---------------|------|
| SIZE | STYLE | ITEM # | LBS. | ITEM # | LBS. | ITEM # | LBS. | ITEM # | LBS. | ITEM # | LBS. |
| 2' x 3' | NYLON | 030266 | .25 | 030295 | .25 | 030313 | .25 | 030329 | .25 | — | — |
| 3' x 5' | NYLON | 030268 | .45 | 030297 | .45 | 030315 | .45 | 030331 | .45 | — | — |
| 4' x 6' | NYLON | 030269 | .70 | 030298 | .70 | 030316 | .70 | 030332 | .70 | — | — |
| 5' x 8' | NYLON | 030270 | 1.0 | 030299 | 1.0 | 030317 | 1.0 | 030333 | 1.0 | — | — |
| 6' x 10' | NYLON | 035015 | 1.8 | 035016 | 1.8 | 035017 | 1.8 | 035018 | 1.8 | — | — |
| 3' x 5' | E-POLY | 030267 | .27 | — | — | — | — | — | — | 030346 | .27 |

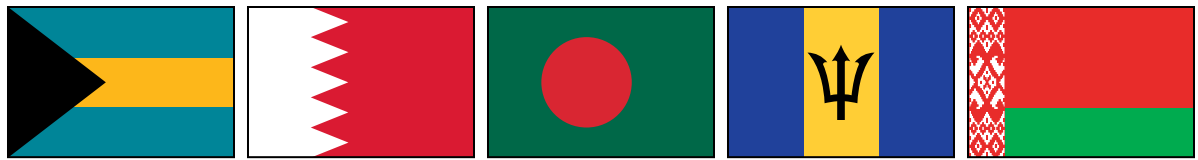

| SPECS | | BAHAMAS (UN/OAS) (D) | | BAHRAIN (UN) (C) | | BANGLADESH (UN) (D) | | BARBADOS (UN/OAS) (D) | | BELARUS (UN) (D) | |
|-----------|-------|-------------------------|------|---------------------|------|------------------------|------|-----------------------------|------|---------------------|------|
| SIZE | STYLE | ITEM # | LBS. | ITEM # | LBS. | ITEM # | LBS. | ITEM # | LBS. | ITEM # | LBS. |
| 12" x 18" | NYLON | — | — | — | — | — | — | 035755 | .10 | — | — |
| 2' x 3' | NYLON | 030355 | .25 | 030374 | .25 | 030391 | .25 | 030409 | .25 | 030432 | .25 |
| 3' x 5' | NYLON | 030357 | .45 | 030376 | .45 | 030393 | .45 | 030411 | .45 | 030433 | .45 |
| 4' x 6' | NYLON | 030358 | .70 | 030377 | .70 | 030394 | .70 | 030412 | .70 | 030434 | .70 |
| 5' x 8' | NYLON | 030359 | 1.0 | 030378 | 1.0 | 030395 | 1.0 | 030413 | 1.0 | 030435 | 1.0 |
| 6' x 10' | NYLON | 035019 | 1.8 | 035020 | 1.8 | 035021 | 1.8 | 035022 | 1.8 | 035024 | 1.8 |



| SPECS | | BELGIUM (UN) (A) | | BELIZE (UN/OAS) (F) | | BENIN (UN) (A) | | BERMUDA (F) | | BHUTAN (UN) (E) | |
|-----------|--------|---------------------|------|------------------------|------|-------------------|------|----------------|------|--------------------|------|
| SIZE | STYLE | ITEM # | LBS. | ITEM # | LBS. | ITEM # | LBS. | ITEM # | LBS. | ITEM # | LBS. |
| 12" x 18" | NYLON | — | — | 035756 | .10 | — | — | — | — | — | — |
| 2' x 3' | NYLON | 030450 | .25 | 030469 | .25 | 030486 | .25 | 030505 | .25 | 030523 | .25 |
| 3' x 5' | NYLON | 030452 | .45 | 030471 | .45 | 030488 | .45 | 030507 | .45 | 030525 | .45 |
| 4' x 6' | NYLON | 030453 | .70 | 030472 | .70 | 030489 | .70 | 030508 | .70 | 030526 | .70 |
| 5' x 8' | NYLON | 030454 | 1.0 | 030473 | 1.0 | 030490 | 1.0 | 030509 | 1.0 | 030527 | 1.0 |
| 6' x 10' | NYLON | 035025 | 1.8 | 035026 | 1.8 | 035027 | 1.8 | 035028 | 1.8 | 035029 | 1.8 |
| 3' x 5' | E-POLY | 030451 | .27 | — | — | — | — | — | — | — | — |

WORLD OUTDOOR FLAG PRICE CLASSIFICATIONS

| SIZE | STYLE | (A) WORLD | | (B) WORLD | | (C) WORLD | | (D) WORLD | | (E) WORLD | | (F) WORLD | |
|-----------|--------|-----------|---------|-----------|---------|-----------|---------|-----------|---------|-----------|---------|-----------|---------|
| | | 1-5 | 6+ | 1-5 | 6+ | 1-5 | 6+ | 1-5 | 6+ | 1-5 | 6+ | 1-5 | 6+ |
| 12" x 18" | NYLON | \$16.10 | \$14.40 | \$17.00 | \$15.60 | \$18.80 | \$17.00 | \$20.70 | \$18.60 | \$20.70 | \$18.60 | \$20.70 | \$18.60 |
| 2' x 3' | NYLON | 27.00 | 24.60 | 33.80 | 30.10 | 39.20 | 35.50 | 44.20 | 39.90 | 47.20 | 41.60 | 60.00 | 53.90 |
| 3' x 5' | NYLON | 36.50 | 32.50 | 54.00 | 49.00 | 62.00 | 55.00 | 63.00 | 57.00 | 72.50 | 65.50 | 83.00 | 74.00 |
| 4' x 6' | NYLON | 50.00 | 44.50 | 85.50 | 77.50 | 90.00 | 81.00 | 93.50 | 85.00 | 103.00 | 92.50 | 115.00 | 103.00 |
| 5' x 8' | NYLON | 78.00 | 75.00 | 112.00 | 108.00 | 126.00 | 121.00 | 128.00 | 122.00 | 147.00 | 142.00 | 156.00 | 146.00 |
| 6' x 10' | NYLON | 126.00 | — | 206.00 | — | 232.00 | — | 252.00 | — | 289.00 | — | 323.00 | — |
| 3' x 5' | E-POLY | 30.00 | 26.50 | 30.00 | 26.50 | 30.00 | 26.50 | 30.00 | 26.50 | 30.00 | 26.50 | 30.00 | 26.50 |

Quantity discounts apply to the same flag & size.



BOLIVIA w/SEAL (UN/OAS) (F)

BOLIVIA (NO SEAL) (A)

BOSNIA & HERZEGOVINA (UN) (E)

BOTSWANA (UN) (A)

BRAZIL (UN/OAS) (D)

| SPECS | | ITEM # | | LBS. | | ITEM # | | LBS. | | ITEM # | | LBS. | |
|-----------|--------|--------|-----|--------|-----|--------|-----|--------|-----|--------|-----|------|--|
| 12" x 18" | NYLON | — | — | — | — | — | — | — | — | 030600 | .10 | | |
| 2' x 3' | NYLON | 030541 | .25 | 030559 | .25 | 030572 | .25 | 030577 | .25 | 030601 | .25 | | |
| 3' x 5' | NYLON | 030543 | .45 | 030560 | .45 | 030573 | .45 | 030579 | .45 | 030603 | .45 | | |
| 4' x 6' | NYLON | 030544 | .70 | 030561 | .70 | 030574 | .70 | 030580 | .70 | 030604 | .70 | | |
| 5' x 8' | NYLON | 030545 | 1.0 | 030562 | 1.0 | 030575 | 1.0 | 030581 | 1.0 | 030605 | 1.0 | | |
| 6' x 10' | NYLON | 035031 | 1.8 | 035030 | 1.8 | 035032 | 1.8 | 035033 | 1.8 | 035034 | 1.8 | | |
| 3' x 5' | E-POLY | 030542 | .27 | — | — | — | — | — | — | 030602 | .27 | | |

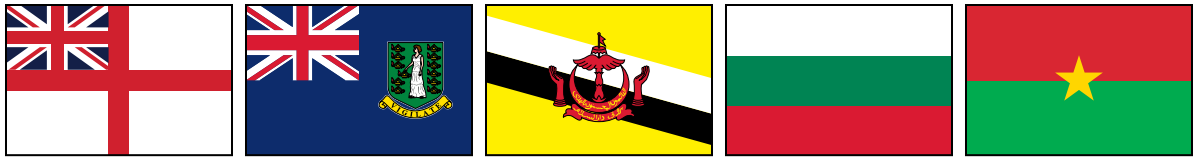

BRITISH NAVY (C)

BRITISH VIRGIN ISLANDS (F)

BRUNEI (UN) (E)

BULGARIA (UN) (A)

BURKINA FASO (UN) (B)

| SPECS | | ITEM # | | LBS. | | ITEM # | | LBS. | | ITEM # | | LBS. | |
|-----------|-------|--------|-----|--------|-----|--------|-----|--------|-----|--------|-----|------|---|
| 12" x 18" | NYLON | — | — | 035757 | .10 | — | — | — | — | — | — | — | — |
| 2' x 3' | NYLON | 030622 | .25 | 030635 | .25 | 030652 | .25 | 030670 | .25 | 030684 | .25 | | |
| 3' x 5' | NYLON | 030623 | .45 | 030637 | .45 | 030654 | .45 | 030671 | .45 | 030686 | .45 | | |
| 4' x 6' | NYLON | 030624 | .70 | 030638 | .70 | 030655 | .70 | 030672 | .70 | 030687 | .70 | | |
| 5' x 8' | NYLON | 030625 | 1.0 | 030639 | 1.0 | 030656 | 1.0 | 030673 | 1.0 | 030688 | 1.0 | | |
| 6' x 10' | NYLON | 035035 | 1.8 | 035036 | 1.8 | 035037 | 1.8 | 035038 | 1.8 | 035039 | 1.8 | | |



BURUNDI (UN) (E)

CAMBODIA (UN) (E)

CAMEROON (UN) (B)

CANADA (UN/OAS) (B)

CANARY ISLANDS (A)

| SPECS | | ITEM # | | LBS. | | ITEM # | | LBS. | | ITEM # | | LBS. | |
|-----------|--------|--------|-----|--------|-----|--------|-----|--------|-----|--------|-----|------|--|
| 12" x 18" | NYLON | — | — | — | — | — | — | 030753 | .10 | 030779 | .10 | | |
| 2' x 3' | NYLON | 030701 | .25 | 030718 | .25 | 030732 | .25 | 030754 | .25 | 030780 | .25 | | |
| 3' x 5' | NYLON | 030703 | .45 | 030719 | .45 | 030734 | .45 | 030756 | .45 | 030781 | .45 | | |
| 4' x 6' | NYLON | 030704 | .70 | 030720 | .70 | 030735 | .70 | 030757 | .70 | 030782 | .70 | | |
| 5' x 8' | NYLON | 030705 | 1.0 | 030721 | 1.0 | 030736 | 1.0 | 030758 | 1.0 | 030783 | 1.0 | | |
| 6' x 10' | NYLON | 035040 | 1.8 | 035041 | 1.8 | 035042 | 1.8 | 035043 | 1.8 | 035044 | 1.8 | | |
| 3' x 5' | E-POLY | — | — | — | — | — | — | 030755 | .27 | — | — | | |

WORLD OUTDOOR FLAG PRICE CLASSIFICATIONS

| SIZE | STYLE | (A) WORLD | | (B) WORLD | | (C) WORLD | | (D) WORLD | | (E) WORLD | | (F) WORLD | |
|-----------|--------|-----------|---------|-----------|---------|-----------|---------|-----------|---------|-----------|---------|-----------|---------|
| | | 1-5 | 6+ | 1-5 | 6+ | 1-5 | 6+ | 1-5 | 6+ | 1-5 | 6+ | 1-5 | 6+ |
| 12" x 18" | NYLON | \$16.10 | \$14.40 | \$17.00 | \$15.60 | \$18.80 | \$17.00 | \$20.70 | \$18.60 | \$20.70 | \$18.60 | \$20.70 | \$18.60 |
| 2' x 3' | NYLON | 27.00 | 24.60 | 33.80 | 30.10 | 39.20 | 35.50 | 44.20 | 39.90 | 47.20 | 41.60 | 60.00 | 53.90 |
| 3' x 5' | NYLON | 36.50 | 32.50 | 54.00 | 49.00 | 62.00 | 55.00 | 63.00 | 57.00 | 72.50 | 65.50 | 83.00 | 74.00 |
| 4' x 6' | NYLON | 50.00 | 44.50 | 85.50 | 77.50 | 90.00 | 81.00 | 93.50 | 85.00 | 103.00 | 92.50 | 115.00 | 103.00 |
| 5' x 8' | NYLON | 78.00 | 75.00 | 112.00 | 108.00 | 126.00 | 121.00 | 128.00 | 122.00 | 147.00 | 142.00 | 156.00 | 146.00 |
| 6' x 10' | NYLON | 126.00 | — | 206.00 | — | 232.00 | — | 252.00 | — | 289.00 | — | 323.00 | — |
| 3' x 5' | E-POLY | 30.00 | 26.50 | 30.00 | 26.50 | 30.00 | 26.50 | 30.00 | 26.50 | 30.00 | 26.50 | 30.00 | 26.50 |

Quantity discounts apply to the same flag & size.

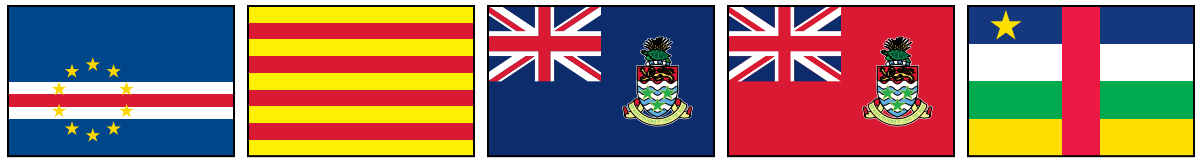

| SPECS | | CAPE VERDE (UN) (E) | | CATALONIA (B) | | CAYMAN ISLANDS (BLUE) (F) | | CAYMAN ISLANDS (RED) (F) | | CENTRAL AFRICAN REPUBLIC (UN) (F) | |
|-----------|-------|---------------------|------|---------------|------|---------------------------|------|--------------------------|------|-----------------------------------|------|
| SIZE | STYLE | ITEM # | LBS. | ITEM # | LBS. | ITEM # | LBS. | ITEM # | LBS. | ITEM # | LBS. |
| 12" x 18" | NYLON | — | — | 030810 | .10 | 035797 | .10 | 030843 | .10 | — | — |
| 2' x 3' | NYLON | 030794 | .25 | 030811 | .25 | 030827 | .25 | 030844 | .25 | 030857 | .25 |
| 3' x 5' | NYLON | 030796 | .45 | 030813 | .45 | 030829 | .45 | 030845 | .45 | 030859 | .45 |
| 4' x 6' | NYLON | 030797 | .70 | 030814 | .70 | 030830 | .70 | 030846 | .70 | 030860 | .70 |
| 5' x 8' | NYLON | 030798 | 1.0 | 030815 | 1.0 | 030831 | 1.0 | 030847 | 1.0 | 030861 | 1.0 |
| 6' x 10' | NYLON | 035045 | 1.8 | 035046 | 1.8 | 035047 | 1.8 | 035048 | 1.8 | 035049 | 1.8 |

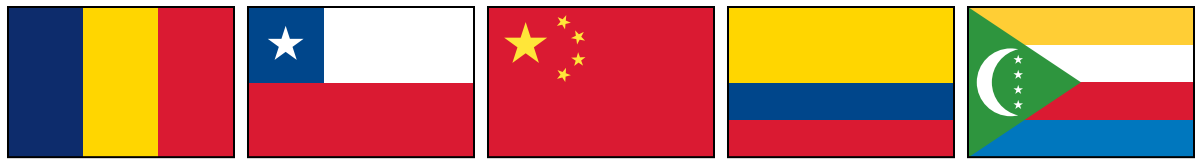

| SPECS | | CHAD (UN) (A) | | CHILE (UN/OAS) (C) | | CHINA (UN) (C) | | COLOMBIA (UN/OAS) (A) | | COMOROS (UN) (E) | |
|-----------|--------|---------------|------|--------------------|------|----------------|------|-----------------------|------|------------------|------|
| SIZE | STYLE | ITEM # | LBS. | ITEM # | LBS. | ITEM # | LBS. | ITEM # | LBS. | ITEM # | LBS. |
| 12" x 18" | NYLON | — | — | 035760 | .10 | — | — | — | — | — | — |
| 2' x 3' | NYLON | 030875 | .25 | 030890 | .25 | 030911 | .25 | 030937 | .25 | 030959 | .25 |
| 3' x 5' | NYLON | 030876 | .45 | 030892 | .45 | 030913 | .45 | 030939 | .45 | 030961 | .45 |
| 4' x 6' | NYLON | 030877 | .70 | 030893 | .70 | 030914 | .70 | 030940 | .70 | 030962 | .70 |
| 5' x 8' | NYLON | 030878 | 1.0 | 030894 | 1.0 | 030915 | 1.0 | 030941 | 1.0 | 030963 | 1.0 |
| 6' x 10' | NYLON | 035050 | 1.8 | 035051 | 1.8 | 035052 | 1.8 | 035054 | 1.8 | 035055 | 1.8 |
| 3' x 5' | E-POLY | — | — | 030891 | .27 | 030912 | .27 | 030938 | .27 | — | — |



| SPECS | | CONGO DEMOCRATIC REPUBLIC (UN) (D) | | CONGO REPUBLIC (UN) (D) | | COSTA RICA w/SEAL (UN/OAS) (F) | | COSTA RICA (NO SEAL) (A) | | CÔTE D'IVOIRE (UN) (A) | |
|-----------|-------|------------------------------------|------|-------------------------|------|--------------------------------|------|--------------------------|------|------------------------|------|
| SIZE | STYLE | ITEM # | LBS. | ITEM # | LBS. | ITEM # | LBS. | ITEM # | LBS. | ITEM # | LBS. |
| 12" x 18" | NYLON | — | — | — | — | — | — | 031034 | .10 | 031048 | .10 |
| 2' x 3' | NYLON | 030979 | .25 | 030994 | .25 | 031016 | .25 | 031035 | .25 | 031049 | .25 |
| 3' x 5' | NYLON | 030980 | .45 | 030995 | .45 | 031018 | .45 | 031036 | .45 | 031050 | .45 |
| 4' x 6' | NYLON | 030981 | .70 | 030996 | .70 | 031019 | .70 | 031037 | .70 | 031051 | .70 |
| 5' x 8' | NYLON | 030982 | 1.0 | 030997 | 1.0 | 031020 | 1.0 | 031038 | 1.0 | 031052 | 1.0 |
| 6' x 10' | NYLON | 035056 | 1.8 | 035057 | 1.8 | 035059 | 1.8 | 035058 | 1.8 | 035060 | 1.8 |

WORLD OUTDOOR FLAG PRICE CLASSIFICATIONS

| SIZE | STYLE | (A) WORLD | | (B) WORLD | | (C) WORLD | | (D) WORLD | | (E) WORLD | | (F) WORLD | |
|-----------|--------|-----------|---------|-----------|---------|-----------|---------|-----------|---------|-----------|---------|-----------|---------|
| | | 1-5 | 6+ | 1-5 | 6+ | 1-5 | 6+ | 1-5 | 6+ | 1-5 | 6+ | 1-5 | 6+ |
| 12" x 18" | NYLON | \$16.10 | \$14.40 | \$17.00 | \$15.60 | \$18.80 | \$17.00 | \$20.70 | \$18.60 | \$20.70 | \$18.60 | \$20.70 | \$18.60 |
| 2' x 3' | NYLON | 27.00 | 24.60 | 33.80 | 30.10 | 39.20 | 35.50 | 44.20 | 39.90 | 47.20 | 41.60 | 60.00 | 53.90 |
| 3' x 5' | NYLON | 36.50 | 32.50 | 54.00 | 49.00 | 62.00 | 55.00 | 63.00 | 57.00 | 72.50 | 65.50 | 83.00 | 74.00 |
| 4' x 6' | NYLON | 50.00 | 44.50 | 85.50 | 77.50 | 90.00 | 81.00 | 93.50 | 85.00 | 103.00 | 92.50 | 115.00 | 103.00 |
| 5' x 8' | NYLON | 78.00 | 75.00 | 112.00 | 108.00 | 126.00 | 121.00 | 128.00 | 122.00 | 147.00 | 142.00 | 156.00 | 146.00 |
| 6' x 10' | NYLON | 126.00 | — | 206.00 | — | 232.00 | — | 252.00 | — | 289.00 | — | 323.00 | — |
| 3' x 5' | E-POLY | 30.00 | 26.50 | 30.00 | 26.50 | 30.00 | 26.50 | 30.00 | 26.50 | 30.00 | 26.50 | 30.00 | 26.50 |

Quantity discounts apply to the same flag & size.



| SPECS | | CROATIA (UN) (D) | | CUBA (UN/OAS) (B) | | CURAÇAO (E) | | CYPRUS (UN) (E) | | CZECH REPUBLIC (UN) (C) | |
|-----------|--------|---------------------|------|----------------------|------|----------------|------|--------------------|------|-------------------------------|------|
| SIZE | STYLE | ITEM # | LBS. | ITEM # | LBS. | ITEM # | LBS. | ITEM # | LBS. | ITEM # | LBS. |
| 12" x 18" | NYLON | — | — | 031086 | .10 | 035762 | .10 | — | — | 035861 | .10 |
| 2' x 3' | NYLON | 031065 | .25 | 031087 | .25 | — | — | 031111 | .25 | 031131 | .25 |
| 3' x 5' | NYLON | 031067 | .45 | 031089 | .45 | — | — | 031113 | .45 | 031133 | .45 |
| 4' x 6' | NYLON | 031068 | .70 | 031090 | .70 | — | — | 031114 | .70 | 031134 | .70 |
| 5' x 8' | NYLON | 031069 | 1.0 | 031091 | 1.0 | — | — | 031115 | 1.0 | 031135 | 1.0 |
| 6' x 10' | NYLON | 035061 | 1.8 | 035062 | 1.8 | — | — | 035063 | 1.8 | 035064 | 1.8 |
| 3' x 5' | E-POLY | — | — | 031088 | .27 | — | — | — | — | 031132 | .27 |

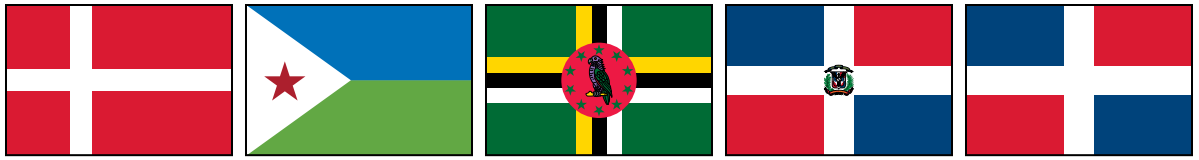

| SPECS | | DENMARK (UN) (B) | | DJIBOUTI (UN) (E) | | DOMINICA (UN/OAS) (F) | | DOMINICAN REPUBLIC w/SEAL (UN/OAS) (F) | | DOMINICAN REPUBLIC (NO SEAL) (B) | |
|-----------|--------|---------------------|------|----------------------|------|--------------------------|------|--|------|--|------|
| SIZE | STYLE | ITEM # | LBS. | ITEM # | LBS. | ITEM # | LBS. | ITEM # | LBS. | ITEM # | LBS. |
| 12" x 18" | NYLON | — | — | — | — | 035763 | .10 | — | — | 031230 | .10 |
| 2' x 3' | NYLON | 031154 | .25 | 031173 | .25 | 031191 | .25 | 031212 | .25 | 031231 | .25 |
| 3' x 5' | NYLON | 031156 | .45 | 031175 | .45 | 031193 | .45 | 031214 | .45 | 031232 | .45 |
| 4' x 6' | NYLON | 031157 | .70 | 031176 | .70 | 031194 | .70 | 031215 | .70 | 031233 | .70 |
| 5' x 8' | NYLON | 031158 | 1.0 | 031177 | 1.0 | 031195 | 1.0 | 031216 | 1.0 | 031234 | 1.0 |
| 6' x 10' | NYLON | 035065 | 1.8 | 035066 | 1.8 | 035067 | 1.8 | 035069 | 1.8 | 035068 | 1.8 |
| 3' x 5' | E-POLY | 031155 | .27 | — | — | — | — | 031213 | .27 | — | — |



| SPECS | | EAST TIMOR (UN) (C) | | ECOLOGY (D) | | ECUADOR w/SEAL (UN/OAS) (F) | | ECUADOR (NO SEAL) (A) | | EGYPT (UN) (C) | |
|----------|--------|------------------------|------|----------------|------|-----------------------------------|------|-----------------------------|------|-------------------|------|
| SIZE | STYLE | ITEM # | LBS. | ITEM # | LBS. | ITEM # | LBS. | ITEM # | LBS. | ITEM # | LBS. |
| 2' x 3' | NYLON | 035801 | .25 | 031250 | .25 | 031270 | .25 | 031289 | .25 | 031305 | .25 |
| 3' x 5' | NYLON | 035802 | .45 | 031251 | .45 | 031272 | .45 | 031290 | .45 | 031307 | .45 |
| 4' x 6' | NYLON | 035803 | .70 | 031252 | .70 | 031273 | .70 | 031291 | .70 | 031308 | .70 |
| 5' x 8' | NYLON | 035804 | 1.0 | 031253 | 1.0 | 031274 | 1.0 | 031292 | 1.0 | 031309 | 1.0 |
| 6' x 10' | NYLON | 035814 | 1.8 | 031254 | 1.8 | 035071 | 1.8 | 035070 | 1.8 | 035072 | 1.8 |
| 3' x 5' | E-POLY | — | — | — | — | 031271 | .27 | — | — | — | — |

WORLD OUTDOOR FLAG PRICE CLASSIFICATIONS

| SIZE | STYLE | (A) WORLD | | (B) WORLD | | (C) WORLD | | (D) WORLD | | (E) WORLD | | (F) WORLD | |
|-----------|--------|-----------|---------|-----------|---------|-----------|---------|-----------|---------|-----------|---------|-----------|---------|
| | | 1-5 | 6+ | 1-5 | 6+ | 1-5 | 6+ | 1-5 | 6+ | 1-5 | 6+ | 1-5 | 6+ |
| 12" x 18" | NYLON | \$16.10 | \$14.40 | \$17.00 | \$15.60 | \$18.80 | \$17.00 | \$20.70 | \$18.60 | \$20.70 | \$18.60 | \$20.70 | \$18.60 |
| 2' x 3' | NYLON | 27.00 | 24.60 | 33.80 | 30.10 | 39.20 | 35.50 | 44.20 | 39.90 | 47.20 | 41.60 | 60.00 | 53.90 |
| 3' x 5' | NYLON | 36.50 | 32.50 | 54.00 | 49.00 | 62.00 | 55.00 | 63.00 | 57.00 | 72.50 | 65.50 | 83.00 | 74.00 |
| 4' x 6' | NYLON | 50.00 | 44.50 | 85.50 | 77.50 | 90.00 | 81.00 | 93.50 | 85.00 | 103.00 | 92.50 | 115.00 | 103.00 |
| 5' x 8' | NYLON | 78.00 | 75.00 | 112.00 | 108.00 | 126.00 | 121.00 | 128.00 | 122.00 | 147.00 | 142.00 | 156.00 | 146.00 |
| 6' x 10' | NYLON | 126.00 | — | 206.00 | — | 232.00 | — | 252.00 | — | 289.00 | — | 323.00 | — |
| 3' x 5' | E-POLY | 30.00 | 26.50 | 30.00 | 26.50 | 30.00 | 26.50 | 30.00 | 26.50 | 30.00 | 26.50 | 30.00 | 26.50 |

Quantity discounts apply to the same flag & size.

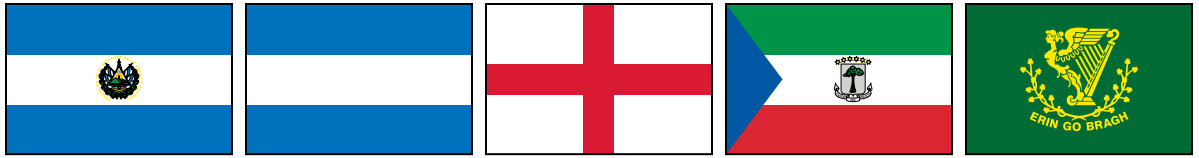

| SPECS | | EL SALVADOR w/SEAL (UN/OAS) (E) | | EL SALVADOR (NO SEAL) (A) | | ENGLAND (B) | | EQUATORIAL GUINEA (UN) (F) | | ERIN GO BRAGH (D) | |
|----------|--------|---------------------------------|------|---------------------------|------|-------------|------|----------------------------|------|-------------------|------|
| SIZE | STYLE | ITEM # | LBS. | ITEM # | LBS. | ITEM # | LBS. | ITEM # | LBS. | ITEM # | LBS. |
| 2' x 3' | NYLON | 031323 | .25 | 031341 | .25 | 031354 | .25 | 031370 | .25 | 031388 | .25 |
| 3' x 5' | NYLON | 031325 | .45 | 031342 | .45 | 031356 | .45 | 031372 | .45 | 031390 | .45 |
| 4' x 6' | NYLON | 031326 | .70 | 031343 | .70 | 031357 | .70 | 031373 | .70 | 031391 | .70 |
| 5' x 8' | NYLON | 031327 | 1.0 | 031344 | 1.0 | 031358 | 1.0 | 031374 | 1.0 | — | — |
| 6' x 10' | NYLON | 035074 | 1.8 | 035073 | 1.8 | 035075 | 1.8 | 035076 | 1.8 | — | — |
| 3' x 5' | E-POLY | 031324 | .27 | — | — | — | — | — | — | — | — |



| SPECS | | ERITREA (UN) (E) | | ESTONIA (UN) (A) | | ETHIOPIA (UN) (D) | | ETHIOPIA w/LION (D) | | EUROPE (D) | |
|----------|--------|------------------|------|------------------|------|-------------------|------|---------------------|------|------------|------|
| SIZE | STYLE | ITEM # | LBS. | ITEM # | LBS. | ITEM # | LBS. | ITEM # | LBS. | ITEM # | LBS. |
| 2' x 3' | NYLON | 031403 | .25 | 031418 | .25 | 031432 | .25 | — | — | 031452 | .25 |
| 3' x 5' | NYLON | 031404 | .45 | 031419 | .45 | 031434 | .45 | — | — | 031454 | .45 |
| 4' x 6' | NYLON | 031405 | .70 | 031420 | .70 | 031435 | .70 | — | — | 031455 | .70 |
| 5' x 8' | NYLON | 031406 | 1.0 | 031421 | 1.0 | 031436 | 1.0 | — | — | 031456 | 1.0 |
| 6' x 10' | NYLON | — | — | 035078 | 1.8 | 035079 | 1.8 | — | — | 035080 | 1.8 |
| 3' x 5' | E-POLY | — | — | — | — | — | — | 031448 | .27 | — | — |

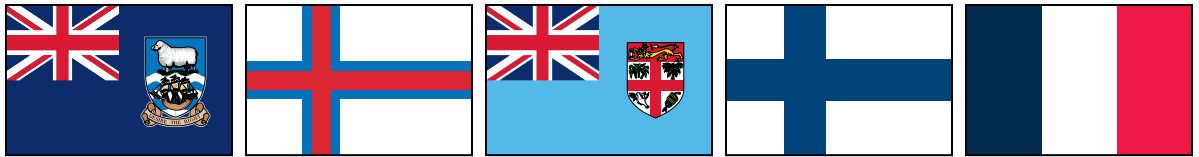

| SPECS | | FALKLAND ISLANDS (F) | | FAROE ISLANDS (B) | | FIJI (UN) (F) | | FINLAND (UN) (B) | | FRANCE (UN) (A) | |
|----------|--------|----------------------|------|-------------------|------|---------------|------|------------------|------|-----------------|------|
| SIZE | STYLE | ITEM # | LBS. | ITEM # | LBS. | ITEM # | LBS. | ITEM # | LBS. | ITEM # | LBS. |
| 2' x 3' | NYLON | 031469 | .25 | 031487 | .25 | 031504 | .25 | 031525 | .25 | 031551 | .25 |
| 3' x 5' | NYLON | 031471 | .45 | 031489 | .45 | 031506 | .45 | 031527 | .45 | 031553 | .45 |
| 4' x 6' | NYLON | 031472 | .70 | 031490 | .70 | 031507 | .70 | 031528 | .70 | 031554 | .70 |
| 5' x 8' | NYLON | 031473 | 1.0 | 031491 | 1.0 | 031508 | 1.0 | 031529 | 1.0 | 031555 | 1.0 |
| 6' x 10' | NYLON | 035081 | 1.8 | 035082 | 1.8 | 035083 | 1.8 | 035084 | 1.8 | 035085 | 1.8 |
| 3' x 5' | E-POLY | — | — | — | — | — | — | — | — | 031552 | .27 |

WORLD OUTDOOR FLAG PRICE CLASSIFICATIONS

| SIZE | STYLE | (A) WORLD | | (B) WORLD | | (C) WORLD | | (D) WORLD | | (E) WORLD | | (F) WORLD | |
|-----------|--------|-----------|---------|-----------|---------|-----------|---------|-----------|---------|-----------|---------|-----------|---------|
| | | 1-5 | 6+ | 1-5 | 6+ | 1-5 | 6+ | 1-5 | 6+ | 1-5 | 6+ | 1-5 | 6+ |
| 12" x 18" | NYLON | \$16.10 | \$14.40 | \$17.00 | \$15.60 | \$18.80 | \$17.00 | \$20.70 | \$18.60 | \$20.70 | \$18.60 | \$20.70 | \$18.60 |
| 2' x 3' | NYLON | 27.00 | 24.60 | 33.80 | 30.10 | 39.20 | 35.50 | 44.20 | 39.90 | 47.20 | 41.60 | 60.00 | 53.90 |
| 3' x 5' | NYLON | 36.50 | 32.50 | 54.00 | 49.00 | 62.00 | 55.00 | 63.00 | 57.00 | 72.50 | 65.50 | 83.00 | 74.00 |
| 4' x 6' | NYLON | 50.00 | 44.50 | 85.50 | 77.50 | 90.00 | 81.00 | 93.50 | 85.00 | 103.00 | 92.50 | 115.00 | 103.00 |
| 5' x 8' | NYLON | 78.00 | 75.00 | 112.00 | 108.00 | 126.00 | 121.00 | 128.00 | 122.00 | 147.00 | 142.00 | 156.00 | 146.00 |
| 6' x 10' | NYLON | 126.00 | — | 206.00 | — | 232.00 | — | 252.00 | — | 289.00 | — | 323.00 | — |
| 3' x 5' | E-POLY | 30.00 | 26.50 | 30.00 | 26.50 | 30.00 | 26.50 | 30.00 | 26.50 | 30.00 | 26.50 | 30.00 | 26.50 |

Quantity discounts apply to the same flag & size.



| SPECS | | FRENCH POLYNESIA (E) | | GABON (UN) (A) | | GAMBIA (UN) (C) | | GEORGIA REPUBLIC (UN) (D) | | GERMANY (UN) (A) | |
|-----------|--------|----------------------|------|----------------|------|-----------------|------|---------------------------|------|------------------|------|
| SIZE | STYLE | ITEM # | LBS. | ITEM # | LBS. | ITEM # | LBS. | ITEM # | LBS. | ITEM # | LBS. |
| 12" x 18" | NYLON | — | — | — | — | — | — | — | — | 031669 | .10 |
| 2' x 3' | NYLON | 031569 | .25 | 031586 | .25 | 031601 | .25 | 031619 | .25 | 031670 | .25 |
| 3' x 5' | NYLON | 031571 | .45 | 031587 | .45 | 031603 | .45 | 031621 | .45 | 031672 | .45 |
| 4' x 6' | NYLON | 031572 | .70 | 031588 | .70 | 031604 | .70 | 031622 | .70 | 031673 | .70 |
| 5' x 8' | NYLON | 031573 | 1.0 | 031589 | 1.0 | 031605 | 1.0 | 031623 | 1.0 | 031674 | 1.0 |
| 6' x 10' | NYLON | 035086 | 1.8 | 035087 | 1.8 | 035088 | 1.8 | 035089 | 1.8 | 035090 | 1.8 |
| 3' x 5' | E-POLY | — | — | — | — | — | — | — | — | 031671 | .27 |

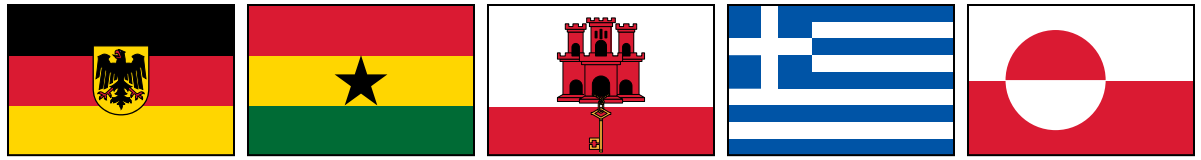

| SPECS | | GERMANY w/EAGLE (D) | | GHANA (UN) (C) | | GIBRALTAR (E) | | GREECE (UN) (B) | | GREENLAND (E) | |
|-----------|--------|---------------------|------|----------------|------|---------------|------|-----------------|------|---------------|------|
| SIZE | STYLE | ITEM # | LBS. | ITEM # | LBS. | ITEM # | LBS. | ITEM # | LBS. | ITEM # | LBS. |
| 12" x 18" | NYLON | — | — | — | — | 035764 | .10 | 031723 | .10 | — | — |
| 2' x 3' | NYLON | 031638 | .25 | 031689 | .25 | 035796 | .25 | 031724 | .25 | — | — |
| 3' x 5' | NYLON | 031640 | .45 | 031691 | .45 | 031707 | .45 | 031726 | .45 | 031744 | .45 |
| 4' x 6' | NYLON | 031641 | .70 | 031692 | .70 | 031708 | .70 | 031727 | .70 | — | — |
| 5' x 8' | NYLON | 031642 | 1.0 | 031693 | 1.0 | 031709 | 1.0 | 031728 | 1.0 | — | — |
| 6' x 10' | NYLON | 035091 | 1.8 | 035092 | 1.8 | 035093 | 1.8 | 035094 | 1.8 | — | — |
| 3' x 5' | E-POLY | 031639 | .27 | 031690 | .27 | — | — | 031725 | .27 | — | — |

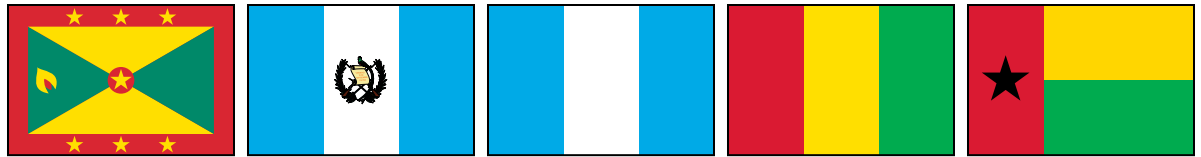

| SPECS | | GRENADA (UN/OAS) (E) | | GUATEMALA w/SEAL (UN/OAS) (E) | | GUATEMALA (NO SEAL) (A) | | GUINEA (UN) (A) | | GUINEA-BISSAU (UN) (C) | |
|-----------|--------|----------------------|------|-------------------------------|------|-------------------------|------|-----------------|------|------------------------|------|
| SIZE | STYLE | ITEM # | LBS. | ITEM # | LBS. | ITEM # | LBS. | ITEM # | LBS. | ITEM # | LBS. |
| 12" x 18" | NYLON | 035765 | .10 | — | — | — | — | — | — | — | — |
| 2' x 3' | NYLON | 031752 | .25 | 031771 | .25 | 031789 | .25 | 031808 | .25 | 031822 | .25 |
| 3' x 5' | NYLON | 031754 | .45 | 031773 | .45 | 031790 | .45 | 031809 | .45 | 031824 | .45 |
| 4' x 6' | NYLON | 031755 | .70 | 031774 | .70 | 031791 | .70 | 031810 | .70 | 031825 | .70 |
| 5' x 8' | NYLON | 031756 | 1.0 | 031775 | 1.0 | 031792 | 1.0 | 031811 | 1.0 | 031826 | 1.0 |
| 6' x 10' | NYLON | — | — | 035097 | 1.8 | 035096 | 1.8 | 035098 | 1.8 | 035099 | 1.8 |
| 3' x 5' | E-POLY | — | — | 031772 | .27 | — | — | — | — | — | — |

WORLD OUTDOOR FLAG PRICE CLASSIFICATIONS

| SIZE | STYLE | (A) WORLD | | (B) WORLD | | (C) WORLD | | (D) WORLD | | (E) WORLD | | (F) WORLD | |
|-----------|--------|-----------|---------|-----------|---------|-----------|---------|-----------|---------|-----------|---------|-----------|---------|
| | | 1-5 | 6+ | 1-5 | 6+ | 1-5 | 6+ | 1-5 | 6+ | 1-5 | 6+ | 1-5 | 6+ |
| 12" x 18" | NYLON | \$16.10 | \$14.40 | \$17.00 | \$15.60 | \$18.80 | \$17.00 | \$20.70 | \$18.60 | \$20.70 | \$18.60 | \$20.70 | \$18.60 |
| 2' x 3' | NYLON | 27.00 | 24.60 | 33.80 | 30.10 | 39.20 | 35.50 | 44.20 | 39.90 | 47.20 | 41.60 | 60.00 | 53.90 |
| 3' x 5' | NYLON | 36.50 | 32.50 | 54.00 | 49.00 | 62.00 | 55.00 | 63.00 | 57.00 | 72.50 | 65.50 | 83.00 | 74.00 |
| 4' x 6' | NYLON | 50.00 | 44.50 | 85.50 | 77.50 | 90.00 | 81.00 | 93.50 | 85.00 | 103.00 | 92.50 | 115.00 | 103.00 |
| 5' x 8' | NYLON | 78.00 | 75.00 | 112.00 | 108.00 | 126.00 | 121.00 | 128.00 | 122.00 | 147.00 | 142.00 | 156.00 | 146.00 |
| 6' x 10' | NYLON | 126.00 | — | 206.00 | — | 232.00 | — | 252.00 | — | 289.00 | — | 323.00 | — |
| 3' x 5' | E-POLY | 30.00 | 26.50 | 30.00 | 26.50 | 30.00 | 26.50 | 30.00 | 26.50 | 30.00 | 26.50 | 30.00 | 26.50 |

Quantity discounts apply to the same flag & size.

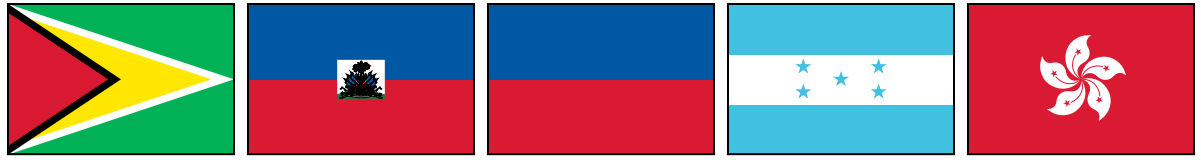

| SPECS | | GUYANA (UN/OAS) (E) | | HAITI w/SEAL (UN/OAS) (F) | | HAITI (NO SEAL) (A) | | HONDURAS (UN/OAS) (C) | | HONG KONG (E) | |
|-----------|--------|------------------------|------|---------------------------------|------|------------------------|------|-----------------------------|------|------------------|------|
| SIZE | STYLE | ITEM # | LBS. | ITEM # | LBS. | ITEM # | LBS. | ITEM # | LBS. | ITEM # | LBS. |
| 12" x 18" | NYLON | — | — | — | — | — | — | 035766 | .10 | — | — |
| 2' x 3' | NYLON | 031840 | .25 | 031859 | .25 | 031877 | .25 | 031894 | .25 | 031912 | .25 |
| 3' x 5' | NYLON | 031842 | .45 | 031861 | .45 | 031878 | .45 | 031896 | .45 | 031913 | .45 |
| 4' x 6' | NYLON | 031843 | .70 | 031862 | .70 | 031879 | .70 | 031897 | .70 | 031914 | .70 |
| 5' x 8' | NYLON | 031844 | 1.0 | 031863 | 1.0 | 031880 | 1.0 | 031898 | 1.0 | 031915 | 1.0 |
| 6' x 10' | NYLON | 035100 | 1.8 | 035102 | 1.8 | 035101 | 1.8 | 035103 | 1.8 | 035104 | 1.8 |
| 3' x 5' | E-POLY | — | — | 031860 | .27 | — | — | 031895 | .27 | — | — |

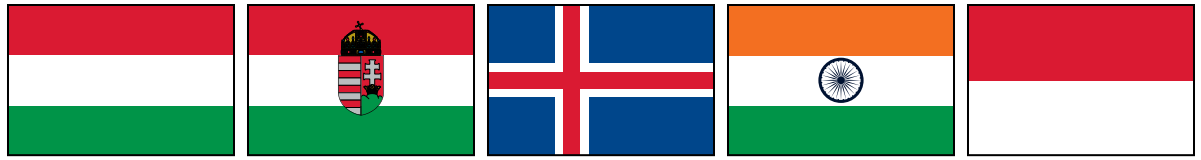

| SPECS | | HUNGARY (UN) (A) | | HUNGARY (1921-1946) (E) | | ICELAND (UN) (C) | | INDIA (UN) (C) | | INDONESIA (UN) (A) | |
|----------|--------|---------------------|------|-------------------------------|------|---------------------|------|-------------------|------|-----------------------|------|
| SIZE | STYLE | ITEM # | LBS. | ITEM # | LBS. | ITEM # | LBS. | ITEM # | LBS. | ITEM # | LBS. |
| 2' x 3' | NYLON | 031928 | .25 | 031945 | .25 | 031960 | .25 | 031983 | .25 | 032003 | .25 |
| 3' x 5' | NYLON | 031930 | .45 | 031947 | .45 | 031962 | .45 | 031985 | .45 | 032005 | .45 |
| 4' x 6' | NYLON | 031931 | .70 | 031948 | .70 | 031963 | .70 | 031986 | .70 | 032006 | .70 |
| 5' x 8' | NYLON | 031932 | 1.0 | 031949 | 1.0 | 031964 | 1.0 | 031987 | 1.0 | 032007 | 1.0 |
| 6' x 10' | NYLON | 035105 | 1.8 | 035106 | 1.8 | 035107 | 1.8 | 035108 | 1.8 | 035109 | 1.8 |
| 3' x 5' | E-POLY | 031929 | .27 | — | — | — | — | 031984 | .27 | — | — |



| SPECS | | IRAN (UN) (C) | | IRAQ (UN) (F) | | IRELAND (UN) (A) | | ISRAEL (UN) (B) | | ITALIAN ENSIGN (E) | |
|-----------|--------|------------------|------|------------------|------|---------------------|------|--------------------|------|-----------------------|------|
| SIZE | STYLE | ITEM # | LBS. | ITEM # | LBS. | ITEM # | LBS. | ITEM # | LBS. | ITEM # | LBS. |
| 12" x 18" | NYLON | — | — | — | — | 032057 | .10 | — | — | — | — |
| 2' x 3' | NYLON | 032020 | .25 | 032037 | .25 | 032058 | .25 | 032081 | .25 | 032099 | .25 |
| 3' x 5' | NYLON | 032022 | .45 | 032039 | .45 | 032060 | .45 | 032083 | .45 | 032101 | .45 |
| 4' x 6' | NYLON | 032023 | .70 | 032040 | .70 | 032061 | .70 | 032084 | .70 | 032102 | .70 |
| 5' x 8' | NYLON | 032024 | 1.0 | 032041 | 1.0 | 032062 | 1.0 | 032085 | 1.0 | 032103 | 1.0 |
| 6' x 10' | NYLON | — | — | 035111 | 1.8 | 035112 | 1.8 | 040113 | 1.8 | 035114 | 1.8 |
| 3' x 5' | E-POLY | — | — | 032038 | .27 | 032059 | .27 | — | — | — | — |

2' x 3' flags sewn back to back. Other sizes two center panels sewn back to back.

WORLD OUTDOOR FLAG PRICE CLASSIFICATIONS

| SIZE | STYLE | (A) WORLD | | (B) WORLD | | (C) WORLD | | (D) WORLD | | (E) WORLD | | (F) WORLD | |
|-----------|--------|-----------|---------|-----------|---------|-----------|---------|-----------|---------|-----------|---------|-----------|---------|
| | | 1-5 | 6+ | 1-5 | 6+ | 1-5 | 6+ | 1-5 | 6+ | 1-5 | 6+ | 1-5 | 6+ |
| 12" x 18" | NYLON | \$16.10 | \$14.40 | \$17.00 | \$15.60 | \$18.80 | \$17.00 | \$20.70 | \$18.60 | \$20.70 | \$18.60 | \$20.70 | \$18.60 |
| 2' x 3' | NYLON | 27.00 | 24.60 | 33.80 | 30.10 | 39.20 | 35.50 | 44.20 | 39.90 | 47.20 | 41.60 | 60.00 | 53.90 |
| 3' x 5' | NYLON | 36.50 | 32.50 | 54.00 | 49.00 | 62.00 | 55.00 | 63.00 | 57.00 | 72.50 | 65.50 | 83.00 | 74.00 |
| 4' x 6' | NYLON | 50.00 | 44.50 | 85.50 | 77.50 | 90.00 | 81.00 | 93.50 | 85.00 | 103.00 | 92.50 | 115.00 | 103.00 |
| 5' x 8' | NYLON | 78.00 | 75.00 | 112.00 | 108.00 | 126.00 | 121.00 | 128.00 | 122.00 | 147.00 | 142.00 | 156.00 | 146.00 |
| 6' x 10' | NYLON | 126.00 | — | 206.00 | — | 232.00 | — | 252.00 | — | 289.00 | — | 323.00 | — |
| 3' x 5' | E-POLY | 30.00 | 26.50 | 30.00 | 26.50 | 30.00 | 26.50 | 30.00 | 26.50 | 30.00 | 26.50 | 30.00 | 26.50 |

Quantity discounts apply to the same flag & size.

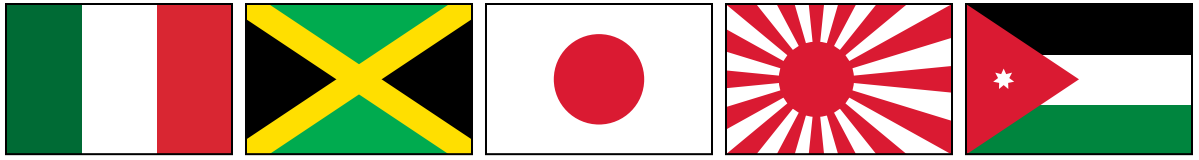

| SPECS | | ITALY (UN) (A) | | JAMAICA (UN/OAS) (D) | | JAPAN (UN) (B) | | JAPANESE ENSIGN (E) | | JORDAN (UN) (D) | |
|-----------|--------|-------------------|------|-------------------------|------|-------------------|------|------------------------|------|--------------------|------|
| SIZE | STYLE | ITEM # | LBS. | ITEM # | LBS. | ITEM # | LBS. | ITEM # | LBS. | ITEM # | LBS. |
| 12" x 18" | NYLON | — | — | 032141 | .10 | 032167 | .10 | — | — | — | — |
| 2' x 3' | NYLON | 032119 | .25 | 032142 | .25 | 032168 | .25 | 032189 | .25 | 032212 | .25 |
| 3' x 5' | NYLON | 032121 | .45 | 032144 | .45 | 032170 | .45 | 032191 | .45 | 032214 | .45 |
| 4' x 6' | NYLON | 032122 | .70 | 032145 | .70 | 032171 | .70 | 032192 | .70 | 032215 | .70 |
| 5' x 8' | NYLON | 032123 | 1.0 | 032146 | 1.0 | 032172 | 1.0 | 032193 | 1.0 | 032216 | 1.0 |
| 6' x 10' | NYLON | 035115 | 1.8 | 035116 | 1.8 | 035117 | 1.8 | — | — | 035119 | 1.8 |
| 3' x 5' | E-POLY | 032120 | .27 | — | — | 032169 | .27 | — | — | — | — |



| SPECS | | KAZAKHSTAN (UN) (D) | | KENYA (UN) (D) | | KIRIBATI (UN) (E) | | NORTH KOREA (UN) (E) | | SOUTH KOREA (UN) (D) | |
|----------|--------|------------------------|------|-------------------|------|----------------------|------|----------------------------|------|----------------------------|------|
| SIZE | STYLE | ITEM # | LBS. | ITEM # | LBS. | ITEM # | LBS. | ITEM # | LBS. | ITEM # | LBS. |
| 2' x 3' | NYLON | 032229 | .25 | 032246 | .25 | 032269 | .25 | 032286 | .25 | 032305 | .25 |
| 3' x 5' | NYLON | 032231 | .45 | 032248 | .45 | 032271 | .45 | 032288 | .45 | 032307 | .45 |
| 4' x 6' | NYLON | 032232 | .70 | 032249 | .70 | 032272 | .70 | 032289 | .70 | 032308 | .70 |
| 5' x 8' | NYLON | 032233 | 1.0 | 032250 | 1.0 | 032273 | 1.0 | 032290 | 1.0 | 032309 | 1.0 |
| 6' x 10' | NYLON | — | — | — | — | — | — | 035165 | 1.8 | 035202 | 1.8 |
| 3' x 5' | E-POLY | — | — | — | — | — | — | — | — | 032306 | .27 |



| SPECS | | KOSOVA (F) | | KUWAIT (UN) (C) | | KYRGYZSTAN (UN) (E) | | LAOS (UN) (C) | | LATVIA (UN) (A) | |
|----------|-------|---------------|------|--------------------|------|------------------------|------|------------------|------|--------------------|------|
| SIZE | STYLE | ITEM # | LBS. | ITEM # | LBS. | ITEM # | LBS. | ITEM # | LBS. | ITEM # | LBS. |
| 2' x 3' | NYLON | 035887 | .25 | 032323 | .25 | 032340 | .25 | 032357 | .25 | 032375 | .25 |
| 3' x 5' | NYLON | 035888 | .45 | 032325 | .45 | 032342 | .45 | 032359 | .45 | 032377 | .45 |
| 4' x 6' | NYLON | 035889 | .70 | 032326 | .70 | 032343 | .70 | 032360 | .70 | 032378 | .70 |
| 5' x 8' | NYLON | 035890 | 1.0 | 032327 | 1.0 | 032344 | 1.0 | 032361 | 1.0 | 032379 | 1.0 |
| 6' x 10' | NYLON | 035891 | 1.8 | 035123 | 1.8 | 035124 | 1.8 | 035125 | 1.8 | 035126 | 1.8 |

WORLD OUTDOOR FLAG PRICE CLASSIFICATIONS

| SIZE | STYLE | (A) WORLD | | (B) WORLD | | (C) WORLD | | (D) WORLD | | (E) WORLD | | (F) WORLD | |
|-----------|--------|-----------|---------|-----------|---------|-----------|---------|-----------|---------|-----------|---------|-----------|---------|
| | | 1-5 | 6+ | 1-5 | 6+ | 1-5 | 6+ | 1-5 | 6+ | 1-5 | 6+ | 1-5 | 6+ |
| 12" x 18" | NYLON | \$16.10 | \$14.40 | \$17.00 | \$15.60 | \$18.80 | \$17.00 | \$20.70 | \$18.60 | \$20.70 | \$18.60 | \$20.70 | \$18.60 |
| 2' x 3' | NYLON | 27.00 | 24.60 | 33.80 | 30.10 | 39.20 | 35.50 | 44.20 | 39.90 | 47.20 | 41.60 | 60.00 | 53.90 |
| 3' x 5' | NYLON | 36.50 | 32.50 | 54.00 | 49.00 | 62.00 | 55.00 | 63.00 | 57.00 | 72.50 | 65.50 | 83.00 | 74.00 |
| 4' x 6' | NYLON | 50.00 | 44.50 | 85.50 | 77.50 | 90.00 | 81.00 | 93.50 | 85.00 | 103.00 | 92.50 | 115.00 | 103.00 |
| 5' x 8' | NYLON | 78.00 | 75.00 | 112.00 | 108.00 | 126.00 | 121.00 | 128.00 | 122.00 | 147.00 | 142.00 | 156.00 | 146.00 |
| 6' x 10' | NYLON | 126.00 | — | 206.00 | — | 232.00 | — | 252.00 | — | 289.00 | — | 323.00 | — |
| 3' x 5' | E-POLY | 30.00 | 26.50 | 30.00 | 26.50 | 30.00 | 26.50 | 30.00 | 26.50 | 30.00 | 26.50 | 30.00 | 26.50 |

Quantity discounts apply to the same flag & size.

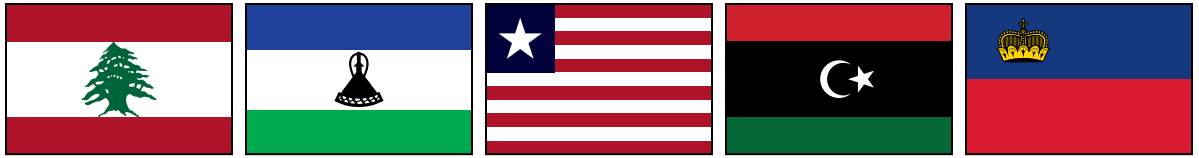

| SPECS | | LEBANON (UN) (D) | | LESOTHO (UN) (D) | | LIBERIA (UN) (D) | | LIBYA (UN) (A) | | LIECHTENSTEIN (UN) (E) | |
|----------|-------|---------------------|------|---------------------|------|---------------------|------|-------------------|------|---------------------------|------|
| SIZE | STYLE | ITEM # | LBS. | ITEM # | LBS. | ITEM # | LBS. | ITEM # | LBS. | ITEM # | LBS. |
| 2' x 3' | NYLON | 032392 | .25 | 032409 | .25 | 032426 | .25 | 032444 | .25 | 032461 | .25 |
| 3' x 5' | NYLON | 032394 | .45 | 032411 | .45 | 032428 | .45 | 032446 | .45 | 032463 | .45 |
| 4' x 6' | NYLON | 032395 | .70 | 032412 | .70 | 032429 | .70 | 032447 | .70 | 032464 | .70 |
| 5' x 8' | NYLON | 032396 | 1.0 | 032413 | 1.0 | 032430 | 1.0 | 032448 | 1.0 | 032465 | 1.0 |
| 6' x 10' | NYLON | 035127 | 1.8 | 035128 | 1.8 | 035129 | 1.8 | 035130 | 1.8 | 035131 | 1.8 |



| SPECS | | LITHUANIA (UN) (A) | | LUXEMBOURG (UN) (A) | | MACAU (F) | | MACEDONIA (UN) (D) | | MADAGASCAR (UN) (A) | |
|----------|-------|-----------------------|------|------------------------|------|--------------|------|-----------------------|------|------------------------|------|
| SIZE | STYLE | ITEM # | LBS. | ITEM # | LBS. | ITEM # | LBS. | ITEM # | LBS. | ITEM # | LBS. |
| 2' x 3' | NYLON | 032479 | .25 | 032499 | .25 | — | — | 032520 | .25 | 032534 | .25 |
| 3' x 5' | NYLON | 032481 | .45 | 032501 | .45 | 032516 | .45 | 032521 | .45 | 032536 | .45 |
| 4' x 6' | NYLON | 032482 | .70 | 032502 | .70 | — | — | 032522 | .70 | 032537 | .70 |
| 5' x 8' | NYLON | 032483 | 1.0 | 032503 | 1.0 | — | — | 032523 | 1.0 | 032538 | 1.0 |
| 6' x 10' | NYLON | 035132 | 1.8 | 035133 | 1.8 | — | — | — | — | 035135 | 1.8 |



| SPECS | | MALAWI (UN) (D) | | MALAYSIA (UN) (E) | | MALDIVES (UN) (D) | | MALI (UN) (A) | | MALTA (UN) (D) | |
|----------|-------|--------------------|------|----------------------|------|----------------------|------|------------------|------|-------------------|------|
| SIZE | STYLE | ITEM # | LBS. | ITEM # | LBS. | ITEM # | LBS. | ITEM # | LBS. | ITEM # | LBS. |
| 2' x 3' | NYLON | 032551 | .25 | 032568 | .25 | 032585 | .25 | 032603 | .25 | 032620 | .25 |
| 3' x 5' | NYLON | 032553 | .45 | 032570 | .45 | 032587 | .45 | 032605 | .45 | 032622 | .45 |
| 4' x 6' | NYLON | 032554 | .70 | 032571 | .70 | 032588 | .70 | 032606 | .70 | 032623 | .70 |
| 5' x 8' | NYLON | 032555 | 1.0 | 032572 | 1.0 | 032589 | 1.0 | 032607 | 1.0 | 032624 | 1.0 |
| 6' x 10' | NYLON | 035136 | 1.8 | 035137 | 1.8 | 035138 | 1.8 | 035139 | 1.8 | 035140 | 1.8 |

| WORLD OUTDOOR FLAG PRICE CLASSIFICATIONS | | | | | | | | | | | | | |
|--|--------|-----------|---------|-----------|---------|-----------|---------|-----------|---------|-----------|---------|-----------|---------|
| SIZE | STYLE | (A) WORLD | | (B) WORLD | | (C) WORLD | | (D) WORLD | | (E) WORLD | | (F) WORLD | |
| | | 1-5 | 6+ | 1-5 | 6+ | 1-5 | 6+ | 1-5 | 6+ | 1-5 | 6+ | 1-5 | 6+ |
| 12' x 18' | NYLON | \$16.10 | \$14.40 | \$17.00 | \$15.60 | \$18.80 | \$17.00 | \$20.70 | \$18.60 | \$20.70 | \$18.60 | \$20.70 | \$18.60 |
| 2' x 3' | NYLON | 27.00 | 24.60 | 33.80 | 30.10 | 39.20 | 35.50 | 44.20 | 39.90 | 47.20 | 41.60 | 60.00 | 53.90 |
| 3' x 5' | NYLON | 36.50 | 32.50 | 54.00 | 49.00 | 62.00 | 55.00 | 63.00 | 57.00 | 72.50 | 65.50 | 83.00 | 74.00 |
| 4' x 6' | NYLON | 50.00 | 44.50 | 85.50 | 77.50 | 90.00 | 81.00 | 93.50 | 85.00 | 103.00 | 92.50 | 115.00 | 103.00 |
| 5' x 8' | NYLON | 78.00 | 75.00 | 112.00 | 108.00 | 126.00 | 121.00 | 128.00 | 122.00 | 147.00 | 142.00 | 156.00 | 146.00 |
| 6' x 10' | NYLON | 126.00 | — | 206.00 | — | 232.00 | — | 252.00 | — | 289.00 | — | 323.00 | — |
| 3' x 5' | E-POLY | 30.00 | 26.50 | 30.00 | 26.50 | 30.00 | 26.50 | 30.00 | 26.50 | 30.00 | 26.50 | 30.00 | 26.50 |

Quantity discounts apply to the same flag & size.



| SPECS | | ISLE OF MAN (E) | | MARSHALL ISLANDS (UN) (C) | | MAURITANIA (UN) (E) | | MAURITIUS (UN) (A) | | MEXICO (UN/OAS) (B) | |
|----------|--------|-----------------|------|---------------------------|------|---------------------|------|--------------------|------|---------------------|------|
| SIZE | STYLE | ITEM # | LBS. | ITEM # | LBS. | ITEM # | LBS. | ITEM # | LBS. | ITEM # | LBS. |
| 2' x 3' | NYLON | — | — | 032645 | .25 | 032662 | .25 | 032680 | .25 | 032701 | .25 |
| 3' x 5' | NYLON | 032638 | .45 | 032647 | .45 | 032664 | .45 | 032682 | .45 | 032703 | .45 |
| 4' x 6' | NYLON | — | — | 032648 | .70 | 032665 | .70 | 032683 | .70 | 032704 | .70 |
| 5' x 8' | NYLON | — | — | 032649 | 1.0 | 032666 | 1.0 | 032684 | 1.0 | 032705 | 1.0 |
| 6' x 10' | NYLON | — | — | 035141 | 1.8 | 035142 | 1.8 | 035143 | 1.8 | 035144 | 1.8 |
| 3' x 5' | E-POLY | — | — | — | — | — | — | — | — | 032702 | .27 |



| SPECS | | MICRONESIA (UN) (B) | | MOLDOVA (UN) (F) | | MONACO (UN) (A) | | MONGOLIA (UN) (D) | | MONTENEGRO (UN) (F) | |
|-----------|-------|---------------------|------|------------------|------|-----------------|------|-------------------|------|---------------------|------|
| SIZE | STYLE | ITEM # | LBS. | ITEM # | LBS. | ITEM # | LBS. | ITEM # | LBS. | ITEM # | LBS. |
| 12" x 18" | NYLON | — | — | — | — | 032757 | .10 | — | — | — | — |
| 2' x 3' | NYLON | 032720 | .25 | 032737 | .25 | 032758 | .25 | 032777 | .25 | 032794 | .25 |
| 3' x 5' | NYLON | 032722 | .45 | 032739 | .45 | 032760 | .45 | 032779 | .45 | 032795 | .45 |
| 4' x 6' | NYLON | 032723 | .70 | 032740 | .70 | 032761 | .70 | 032780 | .70 | 032796 | .70 |
| 5' x 8' | NYLON | 032724 | 1.0 | 032741 | 1.0 | 032762 | 1.0 | 032781 | 1.0 | 032797 | 1.0 |
| 6' x 10' | NYLON | 035145 | 1.8 | 035146 | 1.8 | 035147 | 1.8 | 035148 | 1.8 | 035149 | 1.8 |



| SPECS | | MONTSERRAT (F) | | MOROCCO (UN) (E) | | MOZAMBIQUE (UN) (E) | | MYANMAR (UN) (D) | | NAMIBIA (UN) (E) | |
|----------|-------|----------------|------|------------------|------|---------------------|------|------------------|------|------------------|------|
| SIZE | STYLE | ITEM # | LBS. | ITEM # | LBS. | ITEM # | LBS. | ITEM # | LBS. | ITEM # | LBS. |
| 2' x 3' | NYLON | 035828 | .25 | 032820 | .25 | 032837 | .25 | 032854 | .25 | 032868 | .25 |
| 3' x 5' | NYLON | 032807 | .45 | 032822 | .45 | 032839 | .45 | 032855 | .45 | 032870 | .45 |
| 4' x 6' | NYLON | 032808 | .70 | 032823 | .70 | 032840 | .70 | 032856 | .70 | 032871 | .70 |
| 5' x 8' | NYLON | 032809 | 1.0 | 032824 | 1.0 | 032841 | 1.0 | 032857 | 1.0 | 032872 | 1.0 |
| 6' x 10' | NYLON | 035150 | 1.8 | 035151 | 1.8 | 035152 | 1.8 | 035153 | 1.8 | 035154 | 1.8 |

| WORLD OUTDOOR FLAG PRICE CLASSIFICATIONS | | | | | | | | | | | | | |
|--|--------|-----------|---------|-----------|---------|-----------|---------|-----------|---------|-----------|---------|-----------|---------|
| SIZE | STYLE | (A) WORLD | | (B) WORLD | | (C) WORLD | | (D) WORLD | | (E) WORLD | | (F) WORLD | |
| | | 1-5 | 6+ | 1-5 | 6+ | 1-5 | 6+ | 1-5 | 6+ | 1-5 | 6+ | 1-5 | 6+ |
| 12" x 18" | NYLON | \$16.10 | \$14.40 | \$17.00 | \$15.60 | \$18.80 | \$17.00 | \$20.70 | \$18.60 | \$20.70 | \$18.60 | \$20.70 | \$18.60 |
| 2' x 3' | NYLON | 27.00 | 24.60 | 33.80 | 30.10 | 39.20 | 35.50 | 44.20 | 39.90 | 47.20 | 41.60 | 60.00 | 53.90 |
| 3' x 5' | NYLON | 36.50 | 32.50 | 54.00 | 49.00 | 62.00 | 55.00 | 63.00 | 57.00 | 72.50 | 65.50 | 83.00 | 74.00 |
| 4' x 6' | NYLON | 50.00 | 44.50 | 85.50 | 77.50 | 90.00 | 81.00 | 93.50 | 85.00 | 103.00 | 92.50 | 115.00 | 103.00 |
| 5' x 8' | NYLON | 78.00 | 75.00 | 112.00 | 108.00 | 126.00 | 121.00 | 128.00 | 122.00 | 147.00 | 142.00 | 156.00 | 146.00 |
| 6' x 10' | NYLON | 126.00 | — | 206.00 | — | 232.00 | — | 252.00 | — | 289.00 | — | 323.00 | — |
| 3' x 5' | E-POLY | 30.00 | 26.50 | 30.00 | 26.50 | 30.00 | 26.50 | 30.00 | 26.50 | 30.00 | 26.50 | 30.00 | 26.50 |

Quantity discounts apply to the same flag & size.



| SPECS | | NATO (E) | | NAURU (UN) (E) | | NEPAL (UN) (E) | | NETHERLANDS (UN) (A) | | NETHERLANDS ANTILLES (E) | |
|-----------|--------|----------|------|----------------|------|----------------|------|----------------------|------|--------------------------|------|
| SIZE | STYLE | ITEM # | LBS. | ITEM # | LBS. | ITEM # | LBS. | ITEM # | LBS. | ITEM # | LBS. |
| 12" x 18" | NYLON | — | — | — | — | — | — | — | — | 035767 | .10 |
| 2' x 3' | NYLON | 032885 | .25 | 032902 | .25 | 032919 | .20 | 032940 | .25 | 032959 | .25 |
| 3' x 5' | NYLON | 032887 | .45 | 032904 | .45 | 032921 | .35 | 032942 | .45 | 032961 | .45 |
| 4' x 6' | NYLON | 032888 | .70 | 032905 | .70 | 032922 | .55 | 032943 | .70 | 032962 | .70 |
| 5' x 8' | NYLON | 032889 | 1.0 | 032906 | 1.0 | 032923 | .75 | 032944 | 1.0 | 032963 | 1.0 |
| 6' x 10' | NYLON | 035155 | 1.8 | 035156 | 1.8 | 035157 | 1.8 | 035158 | 1.8 | 035159 | 1.8 |
| 3' x 5' | E-POLY | — | — | — | — | — | — | 032941 | .27 | — | — |



| SPECS | | NEW ZEALAND (UN) (C) | | NICARAGUA w/SEAL (UN/OAS) (F) | | NICARAGUA (NO SEAL) (A) | | NIGER (UN) (C) | | NIGERIA (UN) (A) | |
|----------|--------|----------------------|------|-------------------------------|------|-------------------------|------|----------------|------|------------------|------|
| SIZE | STYLE | ITEM # | LBS. | ITEM # | LBS. | ITEM # | LBS. | ITEM # | LBS. | ITEM # | LBS. |
| 2' x 3' | NYLON | 032978 | .25 | 032998 | .25 | 033016 | .25 | 033029 | .25 | 033047 | .25 |
| 3' x 5' | NYLON | 032980 | .45 | 033000 | .45 | 033017 | .45 | 033031 | .45 | 033049 | .45 |
| 4' x 6' | NYLON | 032981 | .70 | 033001 | .70 | 033018 | .70 | 033032 | .70 | 033050 | .70 |
| 5' x 8' | NYLON | 032982 | 1.0 | 033002 | 1.0 | 033019 | 1.0 | 033033 | 1.0 | 033051 | 1.0 |
| 6' x 10' | NYLON | 035160 | 1.8 | 035162 | 1.8 | 035161 | 1.8 | 035163 | 1.8 | 035164 | 1.8 |
| 3' x 5' | E-POLY | 032979 | .27 | 032999 | .27 | — | — | — | — | 033048 | .27 |



| SPECS | | NORTHERN IRELAND (E) | | NORWAY (UN) (B) | | OAS (F) | | OMAN (UN) (E) | | PAKISTAN (UN) (C) | |
|-----------|--------|----------------------|------|-----------------|------|---------|------|---------------|------|-------------------|------|
| SIZE | STYLE | ITEM # | LBS. | ITEM # | LBS. | ITEM # | LBS. | ITEM # | LBS. | ITEM # | LBS. |
| 12" x 18" | NYLON | — | — | 033082 | .10 | — | — | — | — | 035826 | .10 |
| 2' x 3' | NYLON | — | — | 033083 | .25 | 033101 | .25 | 033131 | .25 | 033149 | .25 |
| 3' x 5' | NYLON | 033070 | .45 | 033085 | .45 | 033103 | .45 | 033133 | .45 | 033151 | .45 |
| 4' x 6' | NYLON | — | — | 033086 | .70 | 033104 | .70 | 033134 | .70 | 033152 | .70 |
| 5' x 8' | NYLON | — | — | 033087 | 1.0 | 033105 | 1.0 | 033135 | 1.0 | 033153 | 1.0 |
| 6' x 10' | NYLON | — | — | 035166 | 1.8 | 035167 | 1.8 | 035168 | 1.8 | 035169 | 1.8 |
| 3' x 5' | E-POLY | — | — | 033084 | .27 | — | — | — | — | 033150 | .27 |

WORLD OUTDOOR FLAG PRICE CLASSIFICATIONS

| SIZE | STYLE | (A) WORLD | | (B) WORLD | | (C) WORLD | | (D) WORLD | | (E) WORLD | | (F) WORLD | |
|-----------|--------|-----------|---------|-----------|---------|-----------|---------|-----------|---------|-----------|---------|-----------|---------|
| | | 1-5 | 6+ | 1-5 | 6+ | 1-5 | 6+ | 1-5 | 6+ | 1-5 | 6+ | 1-5 | 6+ |
| 12" x 18" | NYLON | \$16.10 | \$14.40 | \$17.00 | \$15.60 | \$18.80 | \$17.00 | \$20.70 | \$18.60 | \$20.70 | \$18.60 | \$20.70 | \$18.60 |
| 2' x 3' | NYLON | 27.00 | 24.60 | 33.80 | 30.10 | 39.20 | 35.50 | 44.20 | 39.90 | 47.20 | 41.60 | 60.00 | 53.90 |
| 3' x 5' | NYLON | 36.50 | 32.50 | 54.00 | 49.00 | 62.00 | 55.00 | 63.00 | 57.00 | 72.50 | 65.50 | 83.00 | 74.00 |
| 4' x 6' | NYLON | 50.00 | 44.50 | 85.50 | 77.50 | 90.00 | 81.00 | 93.50 | 85.00 | 103.00 | 92.50 | 115.00 | 103.00 |
| 5' x 8' | NYLON | 78.00 | 75.00 | 112.00 | 108.00 | 126.00 | 121.00 | 128.00 | 122.00 | 147.00 | 142.00 | 156.00 | 146.00 |
| 6' x 10' | NYLON | 126.00 | — | 206.00 | — | 232.00 | — | 252.00 | — | 289.00 | — | 323.00 | — |
| 3' x 5' | E-POLY | 30.00 | 26.50 | 30.00 | 26.50 | 30.00 | 26.50 | 30.00 | 26.50 | 30.00 | 26.50 | 30.00 | 26.50 |

Quantity discounts apply to the same flag & size.

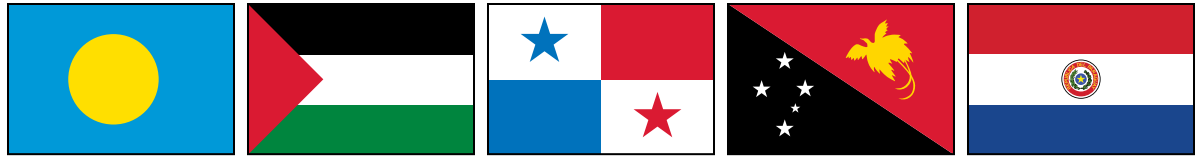

| SPECS | | PALAU (UN) (C) | | PALESTINE (C) | | PANAMA (UN/OAS) (C) | | PAPUA NEW GUINEA (UN) (E) | | PARAGUAY (UN/OAS) (D) | |
|-----------|--------|-------------------|------|------------------|------|------------------------|------|------------------------------|------|--------------------------|------|
| SIZE | STYLE | ITEM # | LBS. | ITEM # | LBS. | ITEM # | LBS. | ITEM # | LBS. | ITEM # | LBS. |
| 12" x 18" | NYLON | 035827 | .10 | — | — | 033204 | .10 | — | — | — | — |
| 2' x 3' | NYLON | 033167 | .25 | 033184 | .25 | 033205 | .25 | 033224 | .25 | 033242 | .25 |
| 3' x 5' | NYLON | 033169 | .45 | 033186 | .45 | 033207 | .45 | 033226 | .45 | 033244 | .45 |
| 4' x 6' | NYLON | 033170 | .70 | 033187 | .70 | 033208 | .70 | 033227 | .70 | 033245 | .70 |
| 5' x 8' | NYLON | 033171 | 1.0 | 033188 | 1.0 | 033209 | 1.0 | 033228 | 1.0 | 033246 | 1.0 |
| 6' x 10' | NYLON | 035170 | 1.8 | 035171 | 1.8 | 035172 | 1.8 | 035173 | 1.8 | 035174 | 1.8 |
| 3' x 5' | E-POLY | — | — | — | — | 033206 | .27 | — | — | — | — |



| SPECS | | PERU w/SEAL (UN/OAS) (E) | | PERU (NO SEAL) (A) | | PHILIPPINES (UN) (D) | | POLAND NO EAGLE (UN) (A) | | POLAND w/EAGLE (D) | |
|-----------|--------|--------------------------------|------|-----------------------|------|-------------------------|------|--------------------------------|------|-----------------------|------|
| SIZE | STYLE | ITEM # | LBS. | ITEM # | LBS. | ITEM # | LBS. | ITEM # | LBS. | ITEM # | LBS. |
| 12" x 18" | NYLON | — | — | — | — | — | — | 033321 | .10 | 033344 | .10 |
| 2' x 3' | NYLON | 033261 | .25 | 033279 | .25 | 033295 | .25 | 033322 | .25 | 033345 | .25 |
| 3' x 5' | NYLON | 033263 | .45 | 033280 | .45 | 033297 | .45 | 033324 | .45 | 033347 | .45 |
| 4' x 6' | NYLON | 033264 | .70 | 033281 | .70 | 033298 | .70 | 033325 | .70 | 033348 | .70 |
| 5' x 8' | NYLON | 033265 | 1.0 | 033282 | 1.0 | 033299 | 1.0 | 033326 | 1.0 | 033349 | 1.0 |
| 6' x 10' | NYLON | 035176 | 1.8 | 035175 | 1.8 | 035177 | 1.8 | 035178 | 1.8 | 035179 | 1.8 |
| 3' x 5' | E-POLY | 033262 | .27 | — | — | 033296 | .27 | — | — | — | — |



| SPECS | | PORTUGAL (UN) (E) | | QATAR (UN) (C) | | ROMANIA (UN) (A) | | RUSSIAN FEDERATION (UN) (A) | | RWANDA (UN) (C) | |
|-----------|--------|----------------------|------|-------------------|------|---------------------|------|--------------------------------|------|--------------------|------|
| SIZE | STYLE | ITEM # | LBS. | ITEM # | LBS. | ITEM # | LBS. | ITEM # | LBS. | ITEM # | LBS. |
| 12" x 18" | NYLON | 035768 | .10 | — | — | 033421 | .10 | 033442 | .10 | — | — |
| 2' x 3' | NYLON | 033367 | .25 | 033386 | .25 | 033422 | .25 | 033443 | .25 | 033465 | .25 |
| 3' x 5' | NYLON | 033369 | .45 | 033388 | .45 | 033424 | .45 | 033445 | .45 | 033467 | .45 |
| 4' x 6' | NYLON | 033370 | .70 | 033389 | .70 | 033425 | .70 | 033446 | .70 | 033468 | .70 |
| 5' x 8' | NYLON | 033371 | 1.0 | 033390 | 1.0 | 033426 | 1.0 | 033447 | 1.0 | 033469 | 1.0 |
| 6' x 10' | NYLON | 035180 | 1.8 | 035181 | 1.8 | 035183 | 1.8 | 035184 | 1.8 | 035185 | 1.8 |
| 3' x 5' | E-POLY | 033368 | .27 | — | — | — | — | 033444 | .27 | — | — |

WORLD OUTDOOR FLAG PRICE CLASSIFICATIONS

| SIZE | STYLE | (A) WORLD | | (B) WORLD | | (C) WORLD | | (D) WORLD | | (E) WORLD | | (F) WORLD | |
|-----------|--------|-----------|---------|-----------|---------|-----------|---------|-----------|---------|-----------|---------|-----------|---------|
| | | 1-5 | 6+ | 1-5 | 6+ | 1-5 | 6+ | 1-5 | 6+ | 1-5 | 6+ | 1-5 | 6+ |
| 12" x 18" | NYLON | \$16.10 | \$14.40 | \$17.00 | \$15.60 | \$18.80 | \$17.00 | \$20.70 | \$18.60 | \$20.70 | \$18.60 | \$20.70 | \$18.60 |
| 2' x 3' | NYLON | 27.00 | 24.60 | 33.80 | 30.10 | 39.20 | 35.50 | 44.20 | 39.90 | 47.20 | 41.60 | 60.00 | 53.90 |
| 3' x 5' | NYLON | 36.50 | 32.50 | 54.00 | 49.00 | 62.00 | 55.00 | 63.00 | 57.00 | 72.50 | 65.50 | 83.00 | 74.00 |
| 4' x 6' | NYLON | 50.00 | 44.50 | 85.50 | 77.50 | 90.00 | 81.00 | 93.50 | 85.00 | 103.00 | 92.50 | 115.00 | 103.00 |
| 5' x 8' | NYLON | 78.00 | 75.00 | 112.00 | 108.00 | 126.00 | 121.00 | 128.00 | 122.00 | 147.00 | 142.00 | 156.00 | 146.00 |
| 6' x 10' | NYLON | 126.00 | — | 206.00 | — | 232.00 | — | 252.00 | — | 289.00 | — | 323.00 | — |
| 3' x 5' | E-POLY | 30.00 | 26.50 | 30.00 | 26.50 | 30.00 | 26.50 | 30.00 | 26.50 | 30.00 | 26.50 | 30.00 | 26.50 |

Quantity discounts apply to the same flag & size.

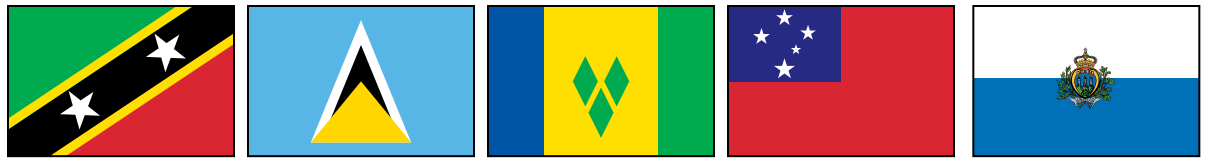

ST. CHRIS-NEVIS (UN/OAS) (D)

ST. LUCIA (UN/OAS) (D)

ST. VINCENT & THE GRENADINES (UN/OAS) (E)

SAMOA (UN) (C)

SAN MARINO w/SEAL (UN) (F)

| SPECS | | ITEM # | LBS. | ITEM # | LBS. | ITEM # | LBS. | ITEM # | LBS. | ITEM # | LBS. |
|-----------|-------|--------|------|--------|------|--------|------|--------|------|--------|------|
| 12" x 18" | NYLON | 035770 | .10 | 035771 | .10 | 035772 | .10 | — | — | — | — |
| 2' x 3' | NYLON | 033483 | .25 | 033519 | .25 | 033538 | .25 | 034526 | .25 | 033556 | .25 |
| 3' x 5' | NYLON | 033485 | .45 | 033521 | .45 | 033540 | .45 | 034528 | .45 | 033558 | .45 |
| 4' x 6' | NYLON | 033486 | .70 | 033522 | .70 | 033541 | .70 | 034529 | .70 | 033559 | .70 |
| 5' x 8' | NYLON | 033487 | 1.0 | 033523 | 1.0 | 033542 | 1.0 | 034530 | 1.0 | 033560 | 1.0 |
| 6' x 10' | NYLON | 035206 | 1.8 | 035208 | 1.8 | 035209 | 1.8 | 035243 | 1.8 | 035187 | 1.8 |



SAN MARINO (NO SEAL) (A)

SÃO TOMÉ & PRÍNCIPE (UN) (E)

SAUDI ARABIA (UN) (C)

SCOTLAND w/LION (D)

SCOTLAND w/CROSS (B)

| SPECS | | ITEM # | LBS. | ITEM # | LBS. | ITEM # | LBS. | ITEM # | LBS. | ITEM # | LBS. |
|-----------|-------|--------|------|--------|------|--------|------|--------|------|--------|------|
| 12" x 18" | NYLON | — | — | — | — | — | — | — | — | 033644 | .10 |
| 2' x 3' | NYLON | 033574 | .25 | 033588 | .25 | 033604 | .25 | 033625 | .25 | 033645 | .25 |
| 3' x 5' | NYLON | 033575 | .45 | 033589 | .45 | 033606 | .45 | 033627 | .45 | 033647 | .45 |
| 4' x 6' | NYLON | 033576 | .70 | 033590 | .70 | 033607 | .70 | 033628 | .70 | 033648 | .70 |
| 5' x 8' | NYLON | 033577 | 1.0 | 033591 | 1.0 | 033608 | 1.0 | 033629 | 1.0 | 033649 | 1.0 |
| 6' x 10' | NYLON | 035186 | 1.8 | 035188 | 1.8 | 035189 | 1.8 | 035191 | 1.8 | 035190 | 1.8 |



SENEGAL (UN) (C)

SERBIA (NO SEAL) (A)

SERBIA w/SEAL (UN) (D)

SEYCHELLES (UN) (E)

SIERRA LEONE (UN) (A)

| SPECS | | ITEM # | LBS. | ITEM # | LBS. | ITEM # | LBS. | ITEM # | LBS. | ITEM # | LBS. |
|----------|-------|--------|------|--------|------|--------|------|--------|------|--------|------|
| 2' x 3' | NYLON | 033663 | .25 | 033680 | .25 | 035873 | .25 | 033701 | .25 | 033720 | .25 |
| 3' x 5' | NYLON | 033665 | .45 | 033681 | .45 | 033694 | .45 | 033703 | .45 | 033722 | .45 |
| 4' x 6' | NYLON | 033666 | .70 | 033682 | .70 | 035874 | .70 | 033704 | .70 | 033723 | .70 |
| 5' x 8' | NYLON | 033667 | 1.0 | 033683 | 1.0 | 035875 | 1.0 | 033705 | 1.0 | 033724 | 1.0 |
| 6' x 10' | NYLON | 035192 | 1.8 | 035193 | 1.8 | 035882 | 1.8 | 035194 | 1.8 | 035195 | 1.8 |

WORLD OUTDOOR FLAG PRICE CLASSIFICATIONS

| SIZE | STYLE | (A) WORLD | | (B) WORLD | | (C) WORLD | | (D) WORLD | | (E) WORLD | | (F) WORLD | |
|-----------|--------|-----------|---------|-----------|---------|-----------|---------|-----------|---------|-----------|---------|-----------|---------|
| | | 1-5 | 6+ | 1-5 | 6+ | 1-5 | 6+ | 1-5 | 6+ | 1-5 | 6+ | 1-5 | 6+ |
| 12" x 18" | NYLON | \$16.10 | \$14.40 | \$17.00 | \$15.60 | \$18.80 | \$17.00 | \$20.70 | \$18.60 | \$20.70 | \$18.60 | \$20.70 | \$18.60 |
| 2' x 3' | NYLON | 27.00 | 24.60 | 33.80 | 30.10 | 39.20 | 35.50 | 44.20 | 39.90 | 47.20 | 41.60 | 60.00 | 53.90 |
| 3' x 5' | NYLON | 36.50 | 32.50 | 54.00 | 49.00 | 62.00 | 55.00 | 63.00 | 57.00 | 72.50 | 65.50 | 83.00 | 74.00 |
| 4' x 6' | NYLON | 50.00 | 44.50 | 85.50 | 77.50 | 90.00 | 81.00 | 93.50 | 85.00 | 103.00 | 92.50 | 115.00 | 103.00 |
| 5' x 8' | NYLON | 78.00 | 75.00 | 112.00 | 108.00 | 126.00 | 121.00 | 128.00 | 122.00 | 147.00 | 142.00 | 156.00 | 146.00 |
| 6' x 10' | NYLON | 126.00 | — | 206.00 | — | 232.00 | — | 252.00 | — | 289.00 | — | 323.00 | — |
| 3' x 5' | E-POLY | 30.00 | 26.50 | 30.00 | 26.50 | 30.00 | 26.50 | 30.00 | 26.50 | 30.00 | 26.50 | 30.00 | 26.50 |

Quantity discounts apply to the same flag & size.

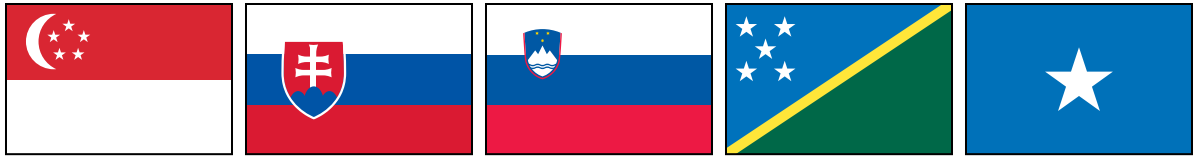

| SPECS | | SINGAPORE (UN) (C) | | SLOVAKIA (UN) (E) | | SLOVENIA (UN) (E) | | SOLOMON ISLANDS (UN) (E) | | SOMALIA (UN) (B) | |
|-----------|-------|-----------------------|------|----------------------|------|----------------------|------|--------------------------------|------|---------------------|------|
| SIZE | STYLE | ITEM # | LBS. | ITEM # | LBS. | ITEM # | LBS. | ITEM # | LBS. | ITEM # | LBS. |
| 12" x 18" | NYLON | — | — | — | — | — | — | 035769 | .10 | — | — |
| 2' x 3' | NYLON | 033739 | .25 | 033757 | .25 | 033774 | .25 | 033794 | .25 | 033811 | .25 |
| 3' x 5' | NYLON | 033741 | .45 | 033759 | .45 | 033776 | .45 | 033796 | .45 | 033813 | .45 |
| 4' x 6' | NYLON | 033742 | .70 | 033760 | .70 | 033777 | .70 | 033797 | .70 | 033814 | .70 |
| 5' x 8' | NYLON | 033743 | 1.0 | 033761 | 1.0 | 033778 | 1.0 | 033798 | 1.0 | 033815 | 1.0 |
| 6' x 10' | NYLON | 035196 | 1.8 | 035197 | 1.8 | 035198 | 1.8 | 035199 | 1.8 | 035200 | 1.8 |



| SPECS | | SOUTH AFRICA (UN) (E) | | SOUTH SUDAN (UN) (E) | | SPAIN w/SEAL (UN) (F) | | SPAIN (NO SEAL) (A) | | SRI LANKA (UN) (E) | |
|-----------|--------|--------------------------|------|-------------------------|------|--------------------------|------|------------------------|------|-----------------------|------|
| SIZE | STYLE | ITEM # | LBS. | ITEM # | LBS. | ITEM # | LBS. | ITEM # | LBS. | ITEM # | LBS. |
| 12" x 18" | NYLON | — | — | — | — | — | — | 033872 | .10 | — | — |
| 2' x 3' | NYLON | 033833 | .25 | 035902 | .25 | 033854 | .25 | 033873 | .25 | 033886 | .25 |
| 3' x 5' | NYLON | 033835 | .45 | 035903 | .45 | 033856 | .45 | 033874 | .45 | 033888 | .45 |
| 4' x 6' | NYLON | 033836 | .70 | 035904 | .70 | 033857 | .70 | 033875 | .70 | 033889 | .70 |
| 5' x 8' | NYLON | 033837 | 1.0 | 035905 | 1.0 | 033858 | 1.0 | 033876 | 1.0 | 033890 | 1.0 |
| 6' x 10' | NYLON | — | — | 035906 | 1.8 | 035204 | 1.8 | 035203 | 1.8 | 035205 | 1.8 |
| 3' x 5' | E-POLY | 033834 | .27 | — | — | 033855 | .27 | — | — | — | — |



| SPECS | | SUDAN (UN) (D) | | SURINAME (UN/OAS) (E) | | SWAZILAND (UN) (E) | | SWEDEN (UN) (A) | | SWITZERLAND (UN) (B) | |
|-----------|--------|-------------------|------|-----------------------------|------|-----------------------|------|--------------------|------|-------------------------|------|
| SIZE | STYLE | ITEM # | LBS. | ITEM # | LBS. | ITEM # | LBS. | ITEM # | LBS. | ITEM # | LBS. |
| 12" x 18" | NYLON | — | — | — | — | — | — | 033959 | .10 | — | — |
| 2' x 3' | NYLON | 033903 | .25 | 033921 | .25 | 033939 | .25 | 033960 | .25 | 033986 | .25 |
| 3' x 5' | NYLON | 033905 | .45 | 033923 | .45 | 033941 | .45 | 033962 | .45 | 033988 | .45 |
| 4' x 6' | NYLON | 033906 | .70 | 033924 | .70 | 033942 | .70 | 033963 | .70 | 033989 | .70 |
| 5' x 8' | NYLON | 033907 | 1.0 | 033925 | 1.0 | 033943 | 1.0 | 033964 | 1.0 | 033990 | 1.0 |
| 6' x 10' | NYLON | 035210 | 1.8 | 035211 | 1.8 | 035212 | 1.8 | 035213 | 1.8 | 035214 | 1.8 |
| 3' x 5' | E-POLY | — | — | — | — | — | — | 033961 | .27 | 033987 | .27 |

WORLD OUTDOOR FLAG PRICE CLASSIFICATIONS

| SIZE | STYLE | (A) WORLD | | (B) WORLD | | (C) WORLD | | (D) WORLD | | (E) WORLD | | (F) WORLD | |
|-----------|--------|-----------|---------|-----------|---------|-----------|---------|-----------|---------|-----------|---------|-----------|---------|
| | | 1-5 | 6+ | 1-5 | 6+ | 1-5 | 6+ | 1-5 | 6+ | 1-5 | 6+ | 1-5 | 6+ |
| 12" x 18" | NYLON | \$16.10 | \$14.40 | \$17.00 | \$15.60 | \$18.80 | \$17.00 | \$20.70 | \$18.60 | \$20.70 | \$18.60 | \$20.70 | \$18.60 |
| 2' x 3' | NYLON | 27.00 | 24.60 | 33.80 | 30.10 | 39.20 | 35.50 | 44.20 | 39.90 | 47.20 | 41.60 | 60.00 | 53.90 |
| 3' x 5' | NYLON | 36.50 | 32.50 | 54.00 | 49.00 | 62.00 | 55.00 | 63.00 | 57.00 | 72.50 | 65.50 | 83.00 | 74.00 |
| 4' x 6' | NYLON | 50.00 | 44.50 | 85.50 | 77.50 | 90.00 | 81.00 | 93.50 | 85.00 | 103.00 | 92.50 | 115.00 | 103.00 |
| 5' x 8' | NYLON | 78.00 | 75.00 | 112.00 | 108.00 | 126.00 | 121.00 | 128.00 | 122.00 | 147.00 | 142.00 | 156.00 | 146.00 |
| 6' x 10' | NYLON | 126.00 | — | 206.00 | — | 232.00 | — | 252.00 | — | 289.00 | — | 323.00 | — |
| 3' x 5' | E-POLY | 30.00 | 26.50 | 30.00 | 26.50 | 30.00 | 26.50 | 30.00 | 26.50 | 30.00 | 26.50 | 30.00 | 26.50 |

Quantity discounts apply to the same flag & size.

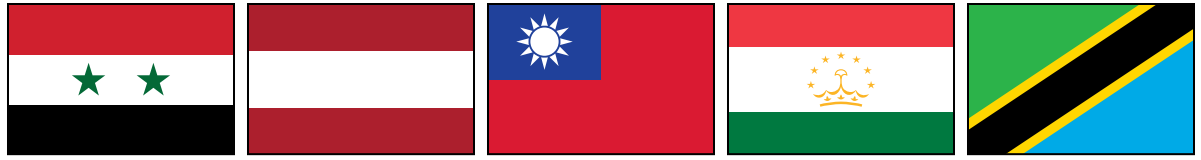

| SYRIA (UN) (C) | | TAHITI (A) | | TAIWAN (C) | | TAJIKISTAN (UN) (D) | | TANZANIA (UN) (D) | | | |
|-------------------|-------|---------------|------|---------------|------|------------------------|------|----------------------|------|--------|------|
| SIZE | STYLE | ITEM # | LBS. | ITEM # | LBS. | ITEM # | LBS. | ITEM # | LBS. | ITEM # | LBS. |
| 12" x 18" | NYLON | — | — | 034021 | .10 | — | — | — | — | — | — |
| 2' x 3' | NYLON | 034005 | .25 | 034022 | .25 | 034038 | .25 | 034057 | .25 | 034074 | .25 |
| 3' x 5' | NYLON | 034007 | .45 | 034023 | .45 | 034040 | .45 | 034059 | .45 | 034076 | .45 |
| 4' x 6' | NYLON | 034008 | .70 | 034024 | .70 | 034041 | .70 | 034060 | .70 | 034077 | .70 |
| 5' x 8' | NYLON | 034009 | 1.0 | 034025 | 1.0 | 034042 | 1.0 | 034061 | 1.0 | 034078 | 1.0 |
| 6' x 10' | NYLON | 035215 | 1.8 | 035216 | 1.8 | 035217 | 1.8 | 035218 | 1.8 | 035219 | 1.8 |



| THAILAND (UN) (A) | | TIBET (F) | | TOGO (UN) (E) | | TONGA (UN) (C) | | TRINIDAD & TOBAGO (UN/OAS) (C) | | | |
|----------------------|--------|--------------|------|------------------|------|-------------------|------|-----------------------------------|------|--------|------|
| SIZE | STYLE | ITEM # | LBS. | ITEM # | LBS. | ITEM # | LBS. | ITEM # | LBS. | ITEM # | LBS. |
| 12" x 18" | NYLON | — | — | — | — | — | — | — | — | 035774 | .10 |
| 2' x 3' | NYLON | 034091 | .25 | — | — | 034113 | .25 | 034130 | .25 | 034150 | .25 |
| 3' x 5' | NYLON | 034093 | .45 | — | — | 034115 | .45 | 034132 | .45 | 034152 | .45 |
| 4' x 6' | NYLON | 034094 | .70 | — | — | 034116 | .70 | 034133 | .70 | 034153 | .70 |
| 5' x 8' | NYLON | 034095 | 1.0 | — | — | 034117 | 1.0 | 034134 | 1.0 | 034154 | 1.0 |
| 6' x 10' | NYLON | 035220 | 1.8 | — | — | 035221 | 1.8 | 035222 | 1.8 | 035223 | 1.8 |
| 3' x 5' | E-POLY | 034092 | .27 | 034108 | .27 | — | — | — | — | — | — |



| TUNISIA (UN) (D) | | TURKEY (UN) (D) | | TURKMENISTAN (UN) (E) | | TURKS & CAICOS (F) | | TUVALU (UN) (E) | | | |
|---------------------|--------|--------------------|------|-----------------------------|------|-----------------------|------|--------------------|------|--------|------|
| SIZE | STYLE | ITEM # | LBS. | ITEM # | LBS. | ITEM # | LBS. | ITEM # | LBS. | ITEM # | LBS. |
| 12" x 18" | NYLON | — | — | 035775 | .10 | — | — | 035776 | .10 | — | — |
| 2' x 3' | NYLON | 034169 | .25 | 034187 | .25 | 034205 | .25 | 034219 | .25 | 035818 | .25 |
| 3' x 5' | NYLON | 034171 | .45 | 034189 | .45 | 034206 | .45 | 034221 | .45 | 034237 | .45 |
| 4' x 6' | NYLON | 034172 | .70 | 034190 | .70 | 034207 | .70 | 034222 | .70 | 035777 | .70 |
| 5' x 8' | NYLON | 034173 | 1.0 | 034191 | 1.0 | 034208 | 1.0 | 034223 | 1.0 | 035778 | 1.0 |
| 6' x 10' | NYLON | 035224 | 1.8 | 035225 | 1.8 | — | — | 035227 | 1.8 | 035783 | 1.8 |
| 3' x 5' | E-POLY | — | — | 034188 | .27 | — | — | — | — | — | — |

WORLD OUTDOOR FLAG PRICE CLASSIFICATIONS

| SIZE | STYLE | (A) WORLD | | (B) WORLD | | (C) WORLD | | (D) WORLD | | (E) WORLD | | (F) WORLD | |
|-----------|--------|-----------|---------|-----------|---------|-----------|---------|-----------|---------|-----------|---------|-----------|---------|
| | | 1-5 | 6+ | 1-5 | 6+ | 1-5 | 6+ | 1-5 | 6+ | 1-5 | 6+ | 1-5 | 6+ |
| 12" x 18" | NYLON | \$16.10 | \$14.40 | \$17.00 | \$15.60 | \$18.80 | \$17.00 | \$20.70 | \$18.60 | \$20.70 | \$18.60 | \$20.70 | \$18.60 |
| 2' x 3' | NYLON | 27.00 | 24.60 | 33.80 | 30.10 | 39.20 | 35.50 | 44.20 | 39.90 | 47.20 | 41.60 | 60.00 | 53.90 |
| 3' x 5' | NYLON | 36.50 | 32.50 | 54.00 | 49.00 | 62.00 | 55.00 | 63.00 | 57.00 | 72.50 | 65.50 | 83.00 | 74.00 |
| 4' x 6' | NYLON | 50.00 | 44.50 | 85.50 | 77.50 | 90.00 | 81.00 | 93.50 | 85.00 | 103.00 | 92.50 | 115.00 | 103.00 |
| 5' x 8' | NYLON | 78.00 | 75.00 | 112.00 | 108.00 | 126.00 | 121.00 | 128.00 | 122.00 | 147.00 | 142.00 | 156.00 | 146.00 |
| 6' x 10' | NYLON | 126.00 | — | 206.00 | — | 232.00 | — | 252.00 | — | 289.00 | — | 323.00 | — |
| 3' x 5' | E-POLY | 30.00 | 26.50 | 30.00 | 26.50 | 30.00 | 26.50 | 30.00 | 26.50 | 30.00 | 26.50 | 30.00 | 26.50 |

Quantity discounts apply to the same flag & size.



| SPECS | | UGANDA (UN) (F) | | UKRAINE (UN) (A) | | UNITED ARAB EMIRATES (UN) (B) | | UNITED KINGDOM (UN) (D) | | UNITED NATIONS (B) | |
|-----------|--------|--------------------|------|---------------------|------|-------------------------------------|------|-------------------------------|------|-----------------------|------|
| SIZE | STYLE | ITEM # | LBS. | ITEM # | LBS. | ITEM # | LBS. | ITEM # | LBS. | ITEM # | LBS. |
| 12" x 18" | NYLON | — | — | — | — | — | — | 034299 | .10 | — | — |
| 2' x 3' | NYLON | 034244 | .25 | 034262 | .25 | 034279 | .25 | 034300 | .25 | 034320 | .25 |
| 3' x 5' | NYLON | 034246 | .45 | 034264 | .45 | 034281 | .45 | 034302 | .45 | 034322 | .45 |
| 4' x 6' | NYLON | 034247 | .70 | 034265 | .70 | 034282 | .70 | 034303 | .70 | 034323 | .70 |
| 5' x 8' | NYLON | 034248 | 1.0 | 034266 | 1.0 | 034283 | 1.0 | 034304 | 1.0 | 034324 | 1.0 |
| 6' x 10' | NYLON | 035228 | 1.8 | 035230 | 1.8 | 035232 | 1.8 | 035229 | 1.8 | 035231 | 1.8 |
| 3' x 5' | E-POLY | — | — | — | — | — | — | 034301 | .27 | 034321 | .27 |



| SPECS | | U.S.S.R. (1955-1991) (C) | | U.S. PRESIDENT (F) | | URUGUAY (UN/OAS) (E) | | UZBEKISTAN (UN) (E) | | VANUATU (UN) (E) | |
|----------|--------|-----------------------------|------|-----------------------|------|-------------------------|------|------------------------|------|---------------------|------|
| SIZE | STYLE | ITEM # | LBS. | ITEM # | LBS. | ITEM # | LBS. | ITEM # | LBS. | ITEM # | LBS. |
| 2' x 3' | NYLON | 034338 | .25 | — | — | 034359 | .25 | 034377 | .25 | 034394 | .25 |
| 3' x 5' | NYLON | 034340 | .45 | — | — | 034361 | .45 | 034379 | .45 | 034396 | .45 |
| 4' x 6' | NYLON | 034341 | .70 | — | — | 034362 | .70 | 034380 | .70 | 034397 | .70 |
| 5' x 8' | NYLON | 034342 | 1.0 | — | — | 034363 | 1.0 | 034381 | 1.0 | 034398 | 1.0 |
| 6' x 10' | NYLON | 035234 | 1.8 | — | — | 035233 | 1.8 | 035235 | 1.8 | — | — |
| 3' x 5' | E-POLY | 034339 | .27 | 034354 | .27 | — | — | — | — | — | — |



| SPECS | | VATICAN CITY (PAPAL) (E) | | VENEZUELA w/SEAL (UN/OAS) (F) | | VENEZUELA (NO SEAL) (D) | | VIETNAM (UN) (C) | | SOUTH VIETNAM (B) | |
|-----------|--------|--------------------------------|------|-------------------------------------|------|-------------------------------|------|---------------------|------|----------------------|------|
| SIZE | STYLE | ITEM # | LBS. | ITEM # | LBS. | ITEM # | LBS. | ITEM # | LBS. | ITEM # | LBS. |
| 12" x 18" | NYLON | — | — | — | — | 034450 | .10 | — | — | — | — |
| 2' x 3' | NYLON | 034412 | .25 | 034431 | .25 | 034451 | .25 | 034466 | .25 | 034483 | .25 |
| 3' x 5' | NYLON | 034414 | .45 | 034433 | .45 | 034452 | .45 | 034468 | .45 | 034485 | .45 |
| 4' x 6' | NYLON | 034415 | .70 | 034434 | .70 | 034453 | .70 | 034469 | .70 | 034486 | .70 |
| 5' x 8' | NYLON | 034416 | 1.0 | 034435 | 1.0 | 034454 | 1.0 | 034470 | 1.0 | 034487 | 1.0 |
| 6' x 10' | NYLON | 035237 | 1.8 | 035239 | 1.8 | 035238 | 1.8 | 035240 | 1.8 | 035241 | 1.8 |
| 3' x 5' | E-POLY | 034413 | .27 | 034432 | .27 | — | — | — | — | — | — |

See [page 16](#) for pole hem and fringe add-ons.

WORLD OUTDOOR FLAG PRICE CLASSIFICATIONS

| SIZE | STYLE | (A) WORLD | | (B) WORLD | | (C) WORLD | | (D) WORLD | | (E) WORLD | | (F) WORLD | |
|-----------|--------|-----------|---------|-----------|---------|-----------|---------|-----------|---------|-----------|---------|-----------|---------|
| | | 1-5 | 6+ | 1-5 | 6+ | 1-5 | 6+ | 1-5 | 6+ | 1-5 | 6+ | 1-5 | 6+ |
| 12" x 18" | NYLON | \$16.10 | \$14.40 | \$17.00 | \$15.60 | \$18.80 | \$17.00 | \$20.70 | \$18.60 | \$20.70 | \$18.60 | \$20.70 | \$18.60 |
| 2' x 3' | NYLON | 27.00 | 24.60 | 33.80 | 30.10 | 39.20 | 35.50 | 44.20 | 39.90 | 47.20 | 41.60 | 60.00 | 53.90 |
| 3' x 5' | NYLON | 36.50 | 32.50 | 54.00 | 49.00 | 62.00 | 55.00 | 63.00 | 57.00 | 72.50 | 65.50 | 83.00 | 74.00 |
| 4' x 6' | NYLON | 50.00 | 44.50 | 85.50 | 77.50 | 90.00 | 81.00 | 93.50 | 85.00 | 103.00 | 92.50 | 115.00 | 103.00 |
| 5' x 8' | NYLON | 78.00 | 75.00 | 112.00 | 108.00 | 126.00 | 121.00 | 128.00 | 122.00 | 147.00 | 142.00 | 156.00 | 146.00 |
| 6' x 10' | NYLON | 126.00 | — | 206.00 | — | 232.00 | — | 252.00 | — | 289.00 | — | 323.00 | — |
| 3' x 5' | E-POLY | 30.00 | 26.50 | 30.00 | 26.50 | 30.00 | 26.50 | 30.00 | 26.50 | 30.00 | 26.50 | 30.00 | 26.50 |

Quantity discounts apply to the same flag & size.



| SPECS | | WALES (D) | | WORLD CO-OP (C) | | YEMEN (UN) (A) | |
|-----------|--------|-----------|------|-----------------|------|----------------|------|
| SIZE | STYLE | ITEM # | LBS. | ITEM # | LBS. | ITEM # | LBS. |
| 12" x 18" | NYLON | — | — | 034542 | .10 | 034559 | .10 |
| 2' x 3' | NYLON | 034504 | .25 | 034543 | .25 | 034560 | .25 |
| 3' x 5' | NYLON | 034506 | .45 | 034544 | .45 | 034561 | .45 |
| 4' x 6' | NYLON | 034507 | .70 | 034545 | .70 | 034562 | .70 |
| 5' x 8' | NYLON | 034508 | 1.0 | 034546 | 1.0 | 034563 | 1.0 |
| 6' x 10' | NYLON | 035242 | 1.8 | 035244 | 1.8 | 035245 | 1.8 |
| 3' x 5' | E-POLY | 034505 | .27 | — | — | — | — |



| SPECS | | ZAMBIA (UN) (E) | | ZIMBABWE (UN) (E) | | BAVARIA (NO LIONS) (E) | |
|----------|-------|-----------------|------|-------------------|------|------------------------|------|
| SIZE | STYLE | ITEM # | LBS. | ITEM # | LBS. | ITEM # | LBS. |
| 2' x 3' | NYLON | 034594 | .25 | 034611 | .25 | 035864 | .25 |
| 3' x 5' | NYLON | 034596 | .45 | 034613 | .45 | 034771 | .45 |
| 4' x 6' | NYLON | 034597 | .70 | 034614 | .70 | 034772 | .70 |
| 5' x 8' | NYLON | 034598 | 1.0 | 034615 | 1.0 | 034773 | 1.0 |
| 6' x 10' | NYLON | 035247 | 1.8 | 035248 | 1.8 | — | — |

| WORLD OUTDOOR FLAG PRICE CLASSIFICATIONS | | | | | | | | | | | | | |
|--|--------|-----------|---------|-----------|---------|-----------|---------|-----------|---------|-----------|---------|-----------|---------|
| SIZE | STYLE | (A) WORLD | | (B) WORLD | | (C) WORLD | | (D) WORLD | | (E) WORLD | | (F) WORLD | |
| | | 1-5 | 6+ | 1-5 | 6+ | 1-5 | 6+ | 1-5 | 6+ | 1-5 | 6+ | 1-5 | 6+ |
| 12" x 18" | NYLON | \$16.10 | \$14.40 | \$17.00 | \$15.60 | \$18.80 | \$17.00 | \$20.70 | \$18.60 | \$20.70 | \$18.60 | \$20.70 | \$18.60 |
| 2' x 3' | NYLON | 27.00 | 24.60 | 33.80 | 30.10 | 39.20 | 35.50 | 44.20 | 39.90 | 47.20 | 41.60 | 60.00 | 53.90 |
| 3' x 5' | NYLON | 36.50 | 32.50 | 54.00 | 49.00 | 62.00 | 55.00 | 63.00 | 57.00 | 72.50 | 65.50 | 83.00 | 74.00 |
| 4' x 6' | NYLON | 50.00 | 44.50 | 85.50 | 77.50 | 90.00 | 81.00 | 93.50 | 85.00 | 103.00 | 92.50 | 115.00 | 103.00 |
| 5' x 8' | NYLON | 78.00 | 75.00 | 112.00 | 108.00 | 126.00 | 121.00 | 128.00 | 122.00 | 147.00 | 142.00 | 156.00 | 146.00 |
| 6' x 10' | NYLON | 126.00 | — | 206.00 | — | 232.00 | — | 252.00 | — | 289.00 | — | 323.00 | — |
| 3' x 5' | E-POLY | 30.00 | 26.50 | 30.00 | 26.50 | 30.00 | 26.50 | 30.00 | 26.50 | 30.00 | 26.50 | 30.00 | 26.50 |



CHICAGO

| ITEM # | SIZE | STYLE | 1-5 | 6+ | LBS. |
|--------|----------|--------|---------|---------|------|
| 034923 | 2' x 3' | NYLON | \$52.80 | \$47.80 | .25 |
| 034925 | 3' x 5' | NYLON | 80.00 | 72.00 | .45 |
| 034926 | 4' x 6' | NYLON | 116.00 | 104.00 | .70 |
| 034927 | 5' x 8' | NYLON | 187.00 | 179.00 | 1.0 |
| 034928 | 6' x 10' | NYLON | 300.00 | — | 1.8 |
| 034929 | 8' x 12' | NYLON | 405.00 | — | 3.1 |
| 034924 | 3' x 5' | E-POLY | 42.00 | 38.00 | .27 |

Quantity discounts apply to the same flag & size.



ENDURA-GLOSS

- Brilliantly printed on silk-like material.
- Hemmed on all four sides.
- Flags mounted on a 3/16" x 10" black plastic staff with gold spear.
- Highest quality mounted flag.
- *Ideal for desktop display.*

| SIZE | 1-11 DOZEN* | 12+ DOZEN* | LBS. |
|---------|-------------|------------|------|
| 4" x 6" | \$31.20 | \$28.08 | .36 |

*SOLD BY THE DOZEN

| DESCRIPTION | ITEM # |
|-----------------------|--------|
| ACADIANA | 030016 |
| ALGERIA | 030078 |
| ANDORRA w/SEAL | 030095 |
| ANGOLA | 030125 |
| ANTIGUA & BARBUDA | 030162 |
| ARUBA | 030243 |
| AUSTRALIA | 030261 |
| AUSTRIA NO EAGLE | 030290 |
| AZORES | 030345 |
| BAHRAIN | 030373 |
| BARBADOS | 030407 |
| BELGIUM | 030445 |
| BENIN | 030485 |
| BHUTAN | 030522 |
| BOTSWANA | 030576 |
| BRAZIL | 030596 |
| BRUNEI | 030651 |
| BURKINA | 030683 |
| BURUNDI | 030700 |
| CAMEROON | 030731 |
| CANARY ISLANDS | 030778 |
| CHAD | 030873 |
| CHINA | 030907 |
| COMOROS | 030958 |
| CONGO DEMOCRATIC REP. | 030978 |
| CONGO REPUBLIC | 030992 |
| COOK ISLANDS | 031007 |

| DESCRIPTION | ITEM # |
|-----------------------|--------|
| COSTA RICA w/SEAL | 031012 |
| CUBA | 031082 |
| DOMINICA | 031189 |
| DOMINICAN REP. w/SEAL | 031208 |
| EAST TIMOR | 035800 |
| ECOLOGY | 031249 |
| EL SALVADOR w/SEAL | 031321 |
| EQUATORIAL GUINEA | 031369 |
| ERIN GO BRAGH | 031386 |
| EUROPE | 031451 |
| FALKLAND ISLANDS | 031468 |
| FAROE ISLANDS | 031485 |
| FIJI | 031503 |
| FRANCE | 031546 |
| GABON | 031584 |
| GIBRALTAR | 031705 |
| GREENLAND | 031742 |
| GUATEMALA w/SEAL | 031769 |
| GUINEA-BISSAU | 031821 |
| GUYANA | 031838 |
| HONG KONG | 031911 |
| HUNGARY | 031925 |
| IRAN | 032019 |
| ISRAEL | 032076 |
| ITALY | 032114 |
| JAPAN | 032163 |
| KIRIBATI | 032268 |

| DESCRIPTION | ITEM # |
|----------------------|--------|
| KUWAIT | 032322 |
| LAOS | 032356 |
| LESOTHO | 032408 |
| LUXEMBOURG | 032495 |
| MACEDONIA | 032519 |
| MADAGASCAR | 032533 |
| MALAYSIA | 032567 |
| MALDIVES | 032584 |
| MALI | 032601 |
| ISLE OF MAN | 032636 |
| MARSHALL ISLANDS | 032644 |
| MAURITANIA | 032661 |
| MAURITIUS | 032678 |
| MONACO | 032753 |
| MONTENEGRO | 035885 |
| MOZAMBIQUE | 032836 |
| MYANMAR | 032853 |
| NAURU | 032901 |
| NETHERLANDS | 032935 |
| NETHERLANDS ANTILLES | 032958 |
| NEW ZEALAND | 032975 |
| NIGER | 033028 |
| OMAN | 033130 |
| PALAU | 033166 |
| PAPUA NEW GUINEA | 033223 |
| PARAGUAY | 033240 |
| PORTUGAL | 033363 |

| DESCRIPTION | ITEM # |
|----------------------|--------|
| RUSSIAN FEDERATION | 033438 |
| ST. LUCIA | 033517 |
| SAMOA | 034525 |
| SAN MARINO w/SEAL | 033555 |
| SAN MARINO (NO SEAL) | 033572 |
| SÃO TOMÉ & PRÍNCIPE | 033587 |
| SAUDI ARABIA | 033601 |
| SEYCHELLES | 033700 |
| SIERRA LEONE | 033718 |
| SINGAPORE | 033736 |
| SOLOMON ISLANDS | 033793 |
| SOMALIA | 033810 |
| SRI LANKA | 033885 |
| SUDAN | 033902 |
| SURINAME | 033919 |
| SWEDEN | 033955 |
| TOGO | 034112 |
| TURKMENISTAN | 034204 |
| TUVALU | 034235 |
| UNITED ARAB EMIRATES | 034278 |
| UNITED NATIONS | 034318 |
| VANUATU | 034393 |
| VATICAN CITY (PAPAL) | 034410 |
| MISCELLANEOUS | ITEM # |
| CHICAGO | 034922 |

WORLD OUTDOOR FLAG PRICE CLASSIFICATIONS

| SIZE | STYLE | (A) WORLD | | (B) WORLD | | (C) WORLD | | (D) WORLD | | (E) WORLD | | (F) WORLD | |
|-----------|--------|-----------|---------|-----------|---------|-----------|---------|-----------|---------|-----------|---------|-----------|---------|
| | | 1-5 | 6+ | 1-5 | 6+ | 1-5 | 6+ | 1-5 | 6+ | 1-5 | 6+ | 1-5 | 6+ |
| 12" x 18" | NYLON | \$16.10 | \$14.40 | \$17.00 | \$15.60 | \$18.80 | \$17.00 | \$20.70 | \$18.60 | \$20.70 | \$18.60 | \$20.70 | \$18.60 |
| 2' x 3' | NYLON | 27.00 | 24.60 | 33.80 | 30.10 | 39.20 | 35.50 | 44.20 | 39.90 | 47.20 | 41.60 | 60.00 | 53.90 |
| 3' x 5' | NYLON | 36.50 | 32.50 | 54.00 | 49.00 | 62.00 | 55.00 | 63.00 | 57.00 | 72.50 | 65.50 | 83.00 | 74.00 |
| 4' x 6' | NYLON | 50.00 | 44.50 | 85.50 | 77.50 | 90.00 | 81.00 | 93.50 | 85.00 | 103.00 | 92.50 | 115.00 | 103.00 |
| 5' x 8' | NYLON | 78.00 | 75.00 | 112.00 | 108.00 | 126.00 | 121.00 | 128.00 | 122.00 | 147.00 | 142.00 | 156.00 | 146.00 |
| 6' x 10' | NYLON | 126.00 | — | 206.00 | — | 232.00 | — | 252.00 | — | 289.00 | — | 323.00 | — |
| 3' x 5' | E-POLY | 30.00 | 26.50 | 30.00 | 26.50 | 30.00 | 26.50 | 30.00 | 26.50 | 30.00 | 26.50 | 30.00 | 26.50 |

Quantity discounts apply to the same flag & size.

3' x 5' OUTDOOR NYLON FLAGS



ALBERTA (F)

| ITEM # | LBS. |
|--------|------|
| 034728 | .45 |



BRITISH COLUMBIA (E)

| ITEM # | LBS. |
|--------|------|
| 034729 | .45 |

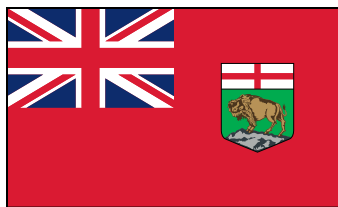

MANITOBA (F)

| ITEM # | LBS. |
|--------|------|
| 034730 | .45 |



NEW BRUNSWICK (E)

| ITEM # | LBS. |
|--------|------|
| 034731 | .45 |

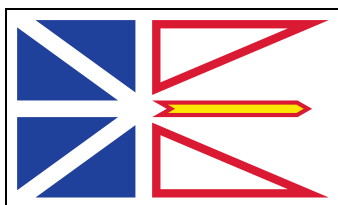

NEWFOUNDLAND (E)

| ITEM # | LBS. |
|--------|------|
| 034732 | .45 |



NW TERRITORIES (F)

| ITEM # | LBS. |
|--------|------|
| 034733 | .45 |

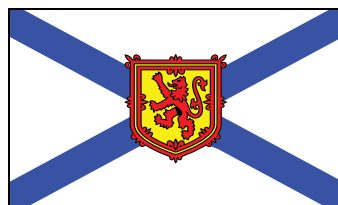

NOVA SCOTIA (E)

| ITEM # | LBS. |
|--------|------|
| 034734 | .45 |

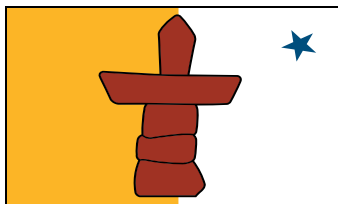

NUNAVAT (E)

| ITEM # | LBS. |
|--------|------|
| 034735 | .45 |

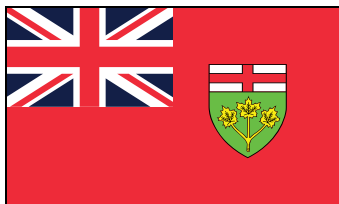

ONTARIO (F)

| ITEM # | LBS. |
|--------|------|
| 034736 | .45 |

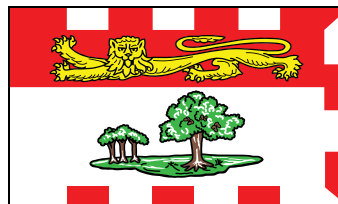

PRINCE EDWARD ISLAND (F)

| ITEM # | LBS. |
|--------|------|
| 034737 | .45 |



QUEBEC (E)

| ITEM # | LBS. |
|--------|------|
| 034738 | .45 |

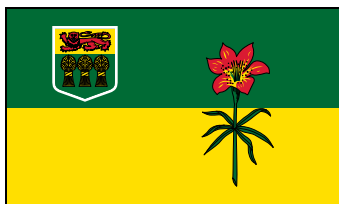

SASKATCHEWAN (E)

| ITEM # | LBS. |
|--------|------|
| 034739 | .45 |



THE YUKON (E)

| ITEM # | LBS. |
|--------|------|
| 034740 | .45 |

CANADIAN OUTDOOR FLAG PRICE CLASSIFICATIONS

| SIZE | STYLE | (E) | | (F) | |
|---------|-------|---------|---------|---------|---------|
| | | 1-5 | 6+ | 1-5 | 6+ |
| 3' x 5' | NYLON | \$72.50 | \$65.50 | \$83.00 | \$74.00 |

4" x 6" MOUNTED E-GLOSS FLAGS



- Brilliantly printed on silk-like material.
- Hemmed on all four sides.
- Flags mounted on a 3/16" x 10" black plastic staff with gold spear.
- Highest quality mounted flag.
- *Ideal for desktop display.*

| PROVINCES & TERRITORIES | ITEM # |
|-------------------------|--------|
| NEW BRUNSWICK | 034666 |
| NEWFOUNDLAND | 034667 |
| NW TERRITORIES | 034668 |
| NUNAVAT | 034670 |
| THE YUKON | 034675 |

| SIZE | 1-11 DOZEN* | 12+ DOZEN* | LBS. |
|---------|-------------|------------|------|
| 4" x 6" | \$31.20 | \$28.08 | .36 |

♦SOLD BY THE DOZEN

Quantity discounts apply to the same flag & size.

CHRISTIAN FLAGS

Deluxe sets include fully sewn, gold fringed nylon flag with appliqued cross, gold cord & tassel, 2-piece pole with brass screw joint, brass plated metal Passion Cross and gold anodized Endura Floor Stand.



Table base not included in pricing.

| DELUXE NYLON SETS WITH OAK POLES | ITEM # | MODEL | FLAG SIZE | POLE SIZE | CROSS HEIGHT x WIDTH | STAND DIA. | PRICE | LBS. |
|----------------------------------|--------|---------|-------------|-------------|----------------------|------------|-----------------|------|
| | 040000 | FSW-300 | 2' x 3' | 7' x 15/16" | 6-1/2" x 4-1/4" | 9" | \$245.00 | 13 |
| | 040001 | FSW-400 | 2-1/2' x 4' | 7' x 15/16" | 6-1/2" x 4-1/4" | 9" | 285.00 | 13 |
| | 040002 | FSW-301 | 3' x 5' | 8' x 1-1/8" | 7-1/2" x 5" | 12" | 295.00 | 22 |
| | 040004 | FSW-46 | 4' x 6' | 9' x 1-1/8" | 7-1/2" x 5" | 12" | 335.00 | 23 |

| DELUXE NYLON SETS WITH GOLD ALUMINUM POLES | ITEM # | MODEL | FLAG SIZE | POLE SIZE | CROSS HEIGHT x WIDTH | STAND DIA. | PRICE | LBS. |
|--|--------|---------|-------------|-------------|----------------------|------------|-----------------|------|
| | 040016 | FSA-300 | 2' x 3' | 7' x 1" | 6-1/2" x 4-1/4" | 9" | \$245.00 | 12 |
| | 040017 | FSA-400 | 2-1/2' x 4' | 7' x 1" | 6-1/2" x 4-1/4" | 9" | 270.00 | 12 |
| | 040018 | FSA-301 | 3' x 5' | 8' x 1-1/8" | 7-1/2" x 5" | 12" | 295.00 | 20 |
| | 040020 | FSA-46 | 4' x 6' | 9' x 1-1/8" | 7-1/2" x 5" | 12" | 320.00 | 21 |

| NYLON INDOOR w/Gold Fringe w/Pole Hem & Mounting Tabs | ITEM # | MODEL | SIZE | 1-5 | 6+ | LBS. |
|---|--------|--------|-------------|----------------|----------------|------|
| | 040066 | FN-6 | 2' x 3' | \$71.60 | \$67.20 | .30 |
| | 040067 | FN-10 | 2-1/2' x 4' | 85.10 | 79.90 | .45 |
| | 040068 | FN-4 | 3' x 5' | 96.60 | 90.70 | .60 |
| | 040070 | FNC-46 | 4' x 6' | 130.50 | 119.50 | .95 |

| NYLON INDOOR (No Fringe) w/Pole Hem & Mounting Tabs | ITEM # | SIZE | 1-5 | 6+ | LBS. |
|---|--------|-------------|----------------|----------------|------|
| | 040080 | 2' x 3' | \$55.50 | \$51.00 | .20 |
| | 040081 | 2-1/2' x 4' | 62.90 | 58.90 | .30 |
| | 040082 | 3' x 5' | 74.10 | 68.50 | .40 |
| | 040084 | 4' x 6' | 104.00 | 94.50 | .65 |

| NYLON OUTDOOR w/Canvas Header & Brass Grommets | ITEM # | SIZE | 1-5 | 6+ | LBS. |
|--|----------|---------------|----------------|----------------|------|
| | 040094 | 2' x 3' | \$39.00 | \$34.50 | .25 |
| | 040096 | 2-1/2' x 4' | 46.40 | 42.40 | .35 |
| | 040098 | 3' x 5' | 53.10 | 47.50 | .45 |
| | 040101 | 4' x 6' | 81.00 | 71.50 | .70 |
| | 040103 | 5' x 8' | 102.50 | 92.00 | 1.0 |
| 040105 | 6' x 10' | 146.00 | 143.00 | 2.0 | |

| ENDURA-POLY™ OUTDOOR w/Canvas Header & Brass Grommets | ITEM # | SIZE | 1-5 | 6+ | LBS. |
|---|--------|-----------|----------------|---------------|------|
| | 040118 | 12" x 18" | \$10.30 | \$9.50 | .30 |

CHRISTIAN MOUNTED FLAGS

With Gold Spears

| ITEM # | FLAG SIZE & MATERIAL | STAFF SIZE, COLOR & MATERIAL | 1-143 | 144+ | LBS. |
|--------|----------------------|------------------------------|---------------|---------------|------|
| 040044 | 12" x 18" COTTON | 3/8" x 30" NATURAL WOOD | \$6.10 | \$4.30 | .13 |



EPISCOPAL NYLON OUTDOOR FLAGS

With Canvas Header & Brass Grommets

| ITEM # | SIZE | 1-5 | 6+ | LBS. |
|--------|---------|----------------|----------------|------|
| 040108 | 3' x 5' | \$81.00 | \$75.50 | .45 |
| 040110 | 4' x 6' | 102.50 | 92.00 | .70 |
| 040111 | 5' x 8' | 127.00 | 124.00 | 1.0 |



BUDDHIST NYLON OUTDOOR FLAGS

With Canvas Header & Brass Grommets

| ITEM # | SIZE | 1-5 | 6+ | LBS. |
|--------|---------|----------------|----------------|------|
| 040157 | 3' x 5' | \$61.60 | \$55.30 | .45 |

Flag Sets Not Intended For Outdoor Display. See [Page 11](#) for Indoor Flag Set Boxing Options.

ISRAEL (ZION) FLAGS

Deluxe sets include gold fringed nylon flag, gold cord & tassel, 2-piece pole with brass screw joint, brass plated metal Star of David and gold anodized Endura™ Floor Stand.



| DELUXE NYLON SETS WITH OAK POLES | ITEM # | MODEL | FLAG SIZE | POLE SIZE | STAR HEIGHT x WIDTH | STAND DIA. | PRICE | LBS. |
|----------------------------------|--------|-------|-----------|-------------|---------------------|------------|----------|------|
| | 040013 | ZW-20 | 3' x 5' | 8' x 1-1/8" | 6-3/4" x 4-3/4" | 12" | \$320.00 | 22 |
| | 040015 | ZW-46 | 4' x 6' | 9' x 1-1/8" | 6-3/4" x 4-3/4" | 12" | 370.00 | 23 |

| DELUXE NYLON SETS WITH GOLD ALUMINUM POLES | ITEM # | MODEL | FLAG SIZE | POLE SIZE | STAR HEIGHT x WIDTH | STAND DIA. | PRICE | LBS. |
|--|--------|-------|-----------|-------------|---------------------|------------|----------|------|
| | 040033 | ZA-20 | 3' x 5' | 8' x 1-1/8" | 6-3/4" x 4-3/4" | 12" | \$325.00 | 20 |
| | 040035 | ZA-46 | 4' x 6' | 9' x 1-1/8" | 6-3/4" x 4-3/4" | 12" | 360.00 | 21 |

See [page 33](#) & [43](#) for individual Israel flag options.

UNITED METHODIST FLAGS

Deluxe sets include gold fringed nylon flag, gold cord & tassel, 2-piece pole with brass screw joint, brass plated metal Passion Cross and gold anodized Endura Floor Stand.



| DELUXE NYLON SETS WITH OAK POLES | ITEM # | FLAG SIZE | POLE SIZE | CROSS HEIGHT x WIDTH | STAND DIA. | PRICE | LBS. |
|----------------------------------|--------|-----------|-------------|----------------------|------------|----------|------|
| | 040129 | 3' x 5' | 8' x 1-1/8" | 7-1/2" x 5" | 12" | \$315.00 | 22 |
| | 040130 | 4' x 6' | 9' x 1-1/8" | 7-1/2" x 5" | 12" | 385.00 | 23 |

| DELUXE NYLON SETS WITH GOLD ALUMINUM POLES | ITEM # | FLAG SIZE | POLE SIZE | CROSS HEIGHT x WIDTH | STAND DIA. | PRICE | LBS. |
|--|--------|-----------|-------------|----------------------|------------|----------|------|
| | 040131 | 3' x 5' | 8' x 1-1/8" | 7-1/2" x 5" | 12" | \$305.00 | 20 |
| | 040132 | 4' x 6' | 9' x 1-1/8" | 7-1/2" x 5" | 12" | 385.00 | 21 |

| INDOOR w/Gold Fringe w/Pole Hem & Mounting Tabs | ITEM # | SIZE | 1-5 | 6+ | LBS. |
|---|--------|---------|----------|---------|------|
| | 040133 | 3' x 5' | \$103.60 | \$97.30 | .45 |
| | 040161 | 4' x 6' | 134.00 | 127.00 | .70 |

| INDOOR (No Fringe) w/Pole Hem & Mounting Tabs | ITEM # | SIZE | 1-5 | 6+ | LBS. |
|---|--------|---------|---------|---------|------|
| | 040135 | 3' x 5' | \$82.60 | \$76.30 | .40 |
| | 040162 | 4' x 6' | 111.00 | 104.00 | .55 |

| OUTDOOR w/Canvas Header & Brass Grommets | ITEM # | SIZE | 1-5 | 6+ | LBS. |
|---|--------|---------|---------|---------|------|
| | 040137 | 3' x 5' | \$61.60 | \$55.30 | .45 |
| | 040138 | 4' x 6' | 88.00 | 81.00 | .70 |
| | 040167 | 5' x 8' | 136.50 | 125.00 | 1 |

PAPAL FLAGS

Deluxe sets include gold fringed nylon flag, gold cord & tassel, 2-piece pole with brass screw joint, brass plated metal Passion Cross and gold anodized Endura Floor Stand.



| DELUXE NYLON SETS WITH OAK POLES | ITEM # | MODEL | FLAG SIZE | POLE SIZE | CROSS HEIGHT x WIDTH | STAND DIA. | PRICE | LBS. |
|----------------------------------|--------|--------|-----------|-------------|----------------------|------------|----------|------|
| | 040006 | FPW-1 | 3' x 5' | 8' x 1-1/8" | 7-1/2" x 5" | 12" | \$345.00 | 22 |
| | 040008 | FPW-46 | 4' x 6' | 9' x 1-1/8" | 7-1/2" x 5" | 12" | 395.00 | 23 |

| DELUXE NYLON SETS WITH GOLD ALUMINUM POLES | ITEM # | MODEL | FLAG SIZE | POLE SIZE | CROSS HEIGHT x WIDTH | STAND DIA. | PRICE | LBS. |
|--|--------|--------|-----------|-------------|----------------------|------------|----------|------|
| | 040024 | FPA-1 | 3' x 5' | 8' x 1-1/8" | 7-1/2" x 5" | 12" | \$335.00 | 20 |
| | 040026 | FPA-46 | 4' x 6' | 9' x 1-1/8" | 7-1/2" x 5" | 12" | 385.00 | 21 |

See [page 41](#) & [43](#) for individual Papal flag options

Flag Sets Not Intended For Outdoor Display. See [Page 11](#) for Indoor Flag Set Boxing Options.



Standard Ferrule Special Ferrule

Where indicated below, our ornaments can be used with a ferrule. A ferrule is used for indoor use on wood poles. When using an ornament for an indoor aluminum pole with a top adapter already installed, a ferrule is not required. The exception to the above is the Elks Head ornament, which is supplied with a threaded rod attached to the bottom and requires a special ferrule for use with our wood indoor poles. Please specify if you require this special ferrule.



HI-IMPACT ABS STYRENE PERCHED EAGLE ORNAMENT

With a shiny multi-layer gold plated finish this eagle is extremely durable. Comes with gold mounting screw. This ABS styrene perched eagle can only be mounted on our oak finished wood poles.

| MODEL | ITEM # | COLOR | HEIGHT | WING SPAN | 1-11 | 12+ | LBS. |
|-------|--------|-------|--------|-----------|---------|---------|------|
| E-7S | 050537 | GOLD | 8-1/4" | 7" | \$33.00 | \$31.50 | .65 |



METAL FLYING EAGLES*

| MODEL | COLOR | HT. | WIDTH | W/ FERRULE (FOR OAK POLES) | | | NO FERRULE (FOR POLES W/ TOP ADAPTER) | | |
|-------|-------|-----|--------|----------------------------|---------|------|---------------------------------------|---------|------|
| | | | | ITEM # | PRICE | LBS. | ITEM # | PRICE | LBS. |
| E-6 | GOLD | 5" | 6-1/2" | 050000 | \$56.50 | 1.0 | 050012 | \$49.00 | .85 |
| E-8 | GOLD | 7" | 8-1/4" | 050002 | 71.00 | 1.4 | 050014 | 64.00 | 1.2 |

*For indoor use only. See [page 139](#) for Outdoor Metal Flying Eagles with Powder Coated Painted Finish.



METAL PERCHED EAGLES

| MODEL | COLOR | HT. | WIDTH | W/ FERRULE (FOR OAK POLES) | | | NO FERRULE (FOR POLES W/ TOP ADAPTER) | | |
|-------|-------|--------|--------|----------------------------|---------|------|---------------------------------------|---------|------|
| | | | | ITEM # | PRICE | LBS. | ITEM # | PRICE | LBS. |
| E-5 | GOLD | 5" | 5" | 050018 | \$61.00 | .80 | 050026 | \$56.50 | .70 |
| E-7 | GOLD | 6-3/4" | 7-1/2" | 050020 | 64.00 | 1.8 | 050028 | 61.00 | 1.7 |



Brass Plated Gold Gold Gilt Finish

PLASTIC SLIP FIT EAGLES

| FOR POLE | HT. | WING SPAN | LBS. | BRASS PLATED | | GOLD GILT | |
|---------------|--------|-----------|------|--------------|--------|-----------|--------|
| | | | | ITEM # | PRICE | ITEM # | PRICE |
| 3/4" ALUMINUM | 3-1/4" | 4-1/4" | .05 | 050031 | \$5.02 | — | — |
| 3/4" STEEL | 3-1/4" | 4-1/4" | .05 | 050032 | 5.02 | 050035 | \$1.78 |
| 1" ALUMINUM | 3-1/4" | 4-1/4" | .05 | 050033 | 5.02 | 050036 | 1.78 |



METAL PASSION CROSSES

| MODEL | COLOR | HT. | WIDTH | W/ FERRULE (FOR OAK POLES) | | | NO FERRULE (FOR POLES W/ TOP ADAPTER) | | |
|-------|-------|--------|-------|----------------------------|---------|------|---------------------------------------|---------|------|
| | | | | ITEM # | PRICE | LBS. | ITEM # | PRICE | LBS. |
| R-30 | GOLD | 7-1/2" | 5" | 050039 | \$62.00 | .85 | 050047 | \$52.50 | .70 |



METAL STAR OF DAVID

| MODEL | COLOR | HT. | WIDTH | W/ FERRULE (FOR OAK POLES) | | | NO FERRULE (FOR POLES W/ TOP ADAPTER) | | |
|-------|-------|--------|--------|----------------------------|---------|------|---------------------------------------|---------|------|
| | | | | ITEM # | PRICE | LBS. | ITEM # | PRICE | LBS. |
| SD-1 | GOLD | 6-3/4" | 4-3/4" | 050073 | \$69.50 | .85 | 050077 | \$61.50 | .70 |



HI-IMPACT ABS STYRENE SPEAR ORNAMENT

With a shiny multi-layer gold plated finish this spear is extremely durable. Comes with gold mounting screw. This ABS styrene spear can only be mounted on our oak finished wood poles.

| ITEM # | COLOR | HEIGHT | 1-11 | 12+ | LBS. |
|--------|-------|--------|---------|---------|------|
| 050548 | GOLD | 8" | \$22.00 | \$21.00 | .12 |



S-105 METAL ROUND SPEARS

| MODEL | COLOR | HT. | WIDTH | W/ FERRULE (FOR OAK POLES) | | | NO FERRULE (FOR POLES W/ TOP ADAPTER) | | |
|-------|-------|-----|--------|----------------------------|---------|------|---------------------------------------|---------|------|
| | | | | ITEM # | PRICE | LBS. | ITEM # | PRICE | LBS. |
| S-105 | GOLD | 8" | 1-3/4" | 050087 | \$79.50 | .80 | 050099 | \$72.50 | .68 |



METAL FLAT SPEARS

| MODEL | COLOR | HT. | WIDTH | W/ FERRULE (FOR OAK POLES) | | | NO FERRULE (FOR POLES W/ TOP ADAPTER) | | |
|-------|--------|--------|--------|----------------------------|---------|------|---------------------------------------|---------|------|
| | | | | ITEM # | PRICE | LBS. | ITEM # | PRICE | LBS. |
| S-102 | GOLD | 7-1/2" | 1-3/4" | 050103 | \$72.50 | .55 | 050111 | \$65.50 | .50 |
| S-102 | SILVER | 7-1/2" | 1-3/4" | 050104 | 72.50 | .65 | 050112 | 65.50 | .50 |



050115 & 050116:
With removable spear top



050119 & 050120:
One piece construction

METAL ARMY SPEARS

| MODEL | COLOR | HT. | WIDTH | W/ FERRULE (FOR OAK POLES) | | | NO FERRULE (FOR POLES W/ TOP ADAPTER) | | |
|-------|--------|--------|--------|----------------------------|---------|------|---------------------------------------|---------|------|
| | | | | ITEM # | PRICE | LBS. | ITEM # | PRICE | LBS. |
| S-100 | GOLD | 8-1/4" | 3-1/2" | 050115 | \$79.50 | .70 | 050119 | \$72.50 | .70 |
| S-100 | SILVER | 8-1/4" | 3-1/2" | 050116 | 79.50 | .70 | 050120 | 72.50 | .70 |



METAL PARADE BALLS

| MODEL | COLOR | HT. | WIDTH | W/ FERRULE (FOR OAK POLES) | | | NO FERRULE (FOR POLES W/ TOP ADAPTER) | | |
|-------|--------|--------|-------|----------------------------|---------|------|---------------------------------------|---------|------|
| | | | | ITEM # | PRICE | LBS. | ITEM # | PRICE | LBS. |
| PB-3 | GOLD | 4-1/4" | 3" | 050127 | \$60.50 | .80 | 050131 | \$49.00 | .70 |
| PB-3 | SILVER | 4-1/4" | 3" | 050128 | 60.50 | .80 | 050132 | 49.00 | .58 |



VINYL SLIP FIT BALLS

Gold Only

| MODEL | ITEM # | FITS OUTSIDE POLE DIA. | HT. | DIA. | PRICE | LBS. |
|--------|--------|------------------------|--------|--------|--------|------|
| VB1516 | 050139 | 15/16" | 2-1/8" | 1-3/4" | \$2.86 | .05 |
| VB1 | 050140 | 1" | 2-1/8" | 1-3/4" | 2.86 | .05 |
| VB138 | 050141 | 1-3/8" | 3-1/4" | 2-1/2" | 4.34 | .10 |
| VB150 | 050142 | 1-1/2" | 3-1/4" | 2-1/2" | 4.34 | .10 |
| VB158 | 050143 | 1-5/8" | 3-1/4" | 2-1/2" | 4.34 | .10 |
| VB175 | 050144 | 1-3/4" | 4-1/4" | 3-1/2" | 11.96 | .20 |



PLASTIC SLIP FIT BALL

Gold Only

| MODEL | ITEM # | FITS OUTSIDE POLE DIA. | HT. | DIA. | PRICE | LBS. |
|-------|--------|------------------------|--------|--------|--------|------|
| GPB-1 | 050145 | 1" | 1-3/8" | 1-5/8" | \$2.58 | .05 |



METAL TEXAS STAR

| MODEL | COLOR | HT. | WIDTH | W/ FERRULE (FOR OAK POLES) | | | NO FERRULE (FOR POLES W/ TOP ADAPTER) | | |
|-------|-------|--------|--------|----------------------------|---------|------|---------------------------------------|---------|------|
| | | | | ITEM # | PRICE | LBS. | ITEM # | PRICE | LBS. |
| TS-1 | GOLD | 6-3/4" | 4-1/4" | 050150 | \$69.50 | .95 | 050154 | \$58.50 | .80 |



METAL MAPLE LEAF

| MODEL | COLOR | HT. | WIDTH | W/ FERRULE (FOR OAK POLES) | | | NO FERRULE (FOR POLES W/ TOP ADAPTER) | | |
|-------|-------|--------|-------|----------------------------|---------|------|---------------------------------------|---------|------|
| | | | | ITEM # | PRICE | LBS. | ITEM # | PRICE | LBS. |
| ML-1 | GOLD | 5-1/4" | 4" | 050167 | \$72.00 | .70 | 050171 | \$65.00 | .80 |



PLASTIC SLIP FIT ACORNS

| MODEL | ITEM # | COLOR | FITS OUTSIDE POLE DIA. | HT. | WIDTH | PRICE | LBS. |
|---------|--------|--------|------------------------|--------|--------|--------|------|
| PA-12 | 050183 | GOLD | 1/2" | 1-3/8" | 1" | \$2.14 | .02 |
| PA-34 | 050184 | GOLD | 3/4" | 2" | 1-1/2" | 3.80 | .03 |
| PA-1516 | 050185 | GOLD | 15/16" | 2-3/8" | 2" | 4.00 | .04 |
| PA-1 | 050186 | GOLD | 1" | 2-3/8" | 2" | 4.00 | .04 |
| PA-1S | 050566 | SILVER | 1" | 2-3/8" | 2" | 4.00 | .04 |



SOLID BRASS SLIP FIT ACORNS

| ITEM # | FITS OUTSIDE POLE DIA. | HT. | WIDTH | PRICE | LBS. |
|--------|------------------------|--------|--------|--------|------|
| 050521 | 3/4" | 2" | 1-1/2" | \$9.50 | .05 |
| 050522 | 1" | 2-3/8" | 2" | 12.80 | .07 |



SLIP FIT WOOD BALL

Natural Color with Lacquer Finish

| MODEL | ITEM # | FITS OUTSIDE POLE DIA. | HT. | WIDTH | PRICE | LBS. |
|-------|--------|------------------------|--------|--------|--------|------|
| SFB | 050166 | 15/16" or 1" | 2-1/4" | 1-3/4" | \$4.20 | .09 |



METAL POINTED BOTTOM FERRULES

Fits a 13/16" outside pole diameter and is 5-1/4" long

| MODEL | ITEM # | COLOR | PRICE | LBS. |
|-------|--------|--------|---------|------|
| BF-1 | 050146 | GOLD | \$74.00 | .70 |
| BF-2 | 050147 | SILVER | 88.50 | .70 |



SEE [PAGE 87](#)
FOR CLEAR PLASTIC
EZ-MOUNT™ FLAG RINGS

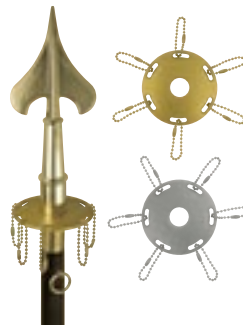

METAL AWARD RIBBON POLE RINGS

Fits over our wood poles with ferrule or our aluminum poles with top adapter already installed. Outside diameter is 3-1/2". Inside Diameter is 7/8".

| ITEM # | COLOR | PRICE | LBS. |
|--------|--------|---------|------|
| 050148 | GOLD | \$61.50 | .20 |
| 050149 | SILVER | 55.50 | .20 |

Army Spear, ferrule & pole are sold separately and are not included in the price.



ENDURA™ FLOOR STANDS

Our most popular floor stand. Comes complete with weighted inner core and brilliant anodized finish.

| MODEL | FOR POLE DIA. | DIA. | HT. | LBS. | GOLD | | | SILVER | | |
|-----------|---------------|------|--------|------|--------|---------|---------|--------|---------|---------|
| | | | | | ITEM # | 1-11 | 12+ | ITEM # | 1-11 | 12+ |
| E200-1516 | 15/16" | 9" | 4-1/2" | 7.7 | 050187 | \$72.00 | \$69.50 | 050194 | \$72.00 | \$69.50 |
| E200-1 | 1" | 9" | 4-1/2" | 7.7 | 050188 | 72.00 | 69.50 | 050195 | 72.00 | 69.50 |
| E100-1516 | 15/16" | 12" | 6" | 13.5 | 050189 | 95.50 | 93.00 | 050196 | 95.50 | 93.00 |
| E100-1 | 1" | 12" | 6" | 13.5 | 050190 | 95.50 | 93.00 | 050197 | 95.50 | 93.00 |
| E100-118 | 1-1/8" | 12" | 6" | 13.5 | 050191 | 95.50 | 93.00 | 050198 | 95.50 | 93.00 |
| E100-114 | 1-1/4" | 12" | 6" | 13.5 | 050192 | 95.50 | 93.00 | 050199 | 95.50 | 93.00 |
| E100-112 | 1-1/2" | 12" | 6" | 13.5 | 050193 | 95.50 | 93.00 | 050200 | 95.50 | 93.00 |



AMERICAN BEAUTY FLOOR STANDS

These cast stands are designed to compliment any flag set. Easily movable, these are the most practical stands for general use. See [page 52](#) for our Guidon Stand.

| MODEL | FOR POLE DIA. | DIA. | HT. | LBS. | GOLD | | | SILVER | | |
|-----------|--------------------|------|--------|------|--------|---------|---------|--------|---------|---------|
| | | | | | ITEM # | 1-11 | 12+ | ITEM # | 1-11 | 12+ |
| B101-VAR* | 15/16", 1" | 9" | 5-1/2" | 7 | 050568 | \$64.00 | \$61.50 | 050569 | \$64.00 | \$61.50 |
| B100-VAR* | 1", 1-1/8", 1-1/4" | 12" | 6" | 13 | 050540 | 102.00 | 99.00 | 050541 | 102.00 | 99.00 |
| B100-138 | 1-3/8" | 12" | 6" | 13 | 050205 | 108.00 | 105.00 | 050210 | 108.00 | 105.00 |

*Supplied with adapter sleeves.



U.S. FLOOR STANDS

Comes complete with gold anodized aluminum outer shell formed around a rugged, cast inner shell.

Model US-101 • Weight: 20.3 lbs.

FEDERAL FLOOR STANDS



Cast stand with universal bore. Supplied with adapter sleeves to accommodate various pole diameters.

Model F-100 • Weight: 8.1 lbs.

| ITEM # | COLOR | FOR POLE DIA. | DIA. | HT. | 1-11 | 12+ |
|--------|-------|---------------|------|--------|----------|----------|
| 050213 | GOLD | 1-1/8" | 12" | 5-1/2" | \$211.00 | \$187.00 |
| 050214 | GOLD | 1-1/4" | 12" | 5-1/2" | 211.00 | 187.00 |

| ITEM # | COLOR | FOR POLE DIA. | DIA. | HT. | 1-11 | 12+ |
|--------|--------|--------------------|---------|--------|----------|---------|
| 050215 | GOLD | 1", 1-1/8", 1-1/4" | 10-3/4" | 5-1/2" | \$103.00 | \$95.50 |
| 050216 | SILVER | 1", 1-1/8", 1-1/4" | 10-3/4" | 5-1/2" | 103.00 | 95.50 |

REGENT FLOOR STANDS



Tough, beautiful plated plastic stand complete with adapter sleeves to accommodate various pole diameters.

| ITEM # | COLOR | FOR POLE DIA. | DIA. | HT. | 1-11 | 12+ |
|--------|--------|--------------------|------|--------|---------|---------|
| 050217 | GOLD | 1", 1-1/8", 1-1/4" | 12" | 5-1/2" | \$74.00 | \$68.00 |
| 050218 | SILVER | 1", 1-1/8", 1-1/4" | 12" | 5-1/2" | 74.00 | 68.00 |

Model PMB-M • Weight: 2.7 lbs., approx. 10 lbs. when filled with sand (not included)

VISCOUNT FLOOR STANDS



Plastic stand with color impregnated finish (not painted) complete with adapter sleeves to accommodate various pole diameters.

| ITEM # | COLOR | FOR POLE DIA. | DIA. | HT. | 1-11 | 12+ |
|--------|--------|--------------------|------|--------|---------|---------|
| 050219 | GOLD | 1", 1-1/8", 1-1/4" | 12" | 5-1/2" | \$58.50 | \$50.50 |
| 050220 | SILVER | 1", 1-1/8", 1-1/4" | 12" | 5-1/2" | 58.50 | 50.50 |

Model PMB-P • Weight: 3.5 lbs., approx. 10 lbs. when filled with sand (not included)



Open

Closed

PORTABLE FLOOR STAND

Made of strong, durable polymer plastic. When completely folded this stand measures only 24" x 2-1/8". Color is rich dark brown to compliment any décor. Supplied with adapter sleeves to accommodate various pole diameters.

| MODEL | ITEM # | FOR POLE DIA. | STAND HT. | 1-23 | 24+ | LBS. |
|-------|--------|--------------------|-----------|---------|---------|------|
| PFS | 050221 | 1", 1-1/8", 1-1/4" | 5-3/4" | \$42.50 | \$33.50 | 1.5 |

THREE HOLE FLOOR STANDS

This cast stand creates a display of 1, 2, or 3 flags. Supplied with adapter sleeves to accommodate various pole diameters.



| MODEL | ITEM # | COLOR | FOR POLE DIA. | DIA. | HT. | LBS. | 1-11 | 12+ |
|-------|--------|--------|--------------------|------|--------|------|----------|----------|
| B-300 | 050211 | GOLD | 1", 1-1/8", 1-1/4" | 12" | 5-1/2" | 32.1 | \$247.00 | \$237.00 |
| B-300 | 050212 | SILVER | 1", 1-1/8", 1-1/4" | 12" | 5-1/2" | 32.1 | 247.00 | 237.00 |

Floor Stands on this page are not intended for outdoor display.
Weights listed on this page are for shipping purposes.

DELUXE ALUMINUM POLES

The Ultimate in an Aluminum Pole

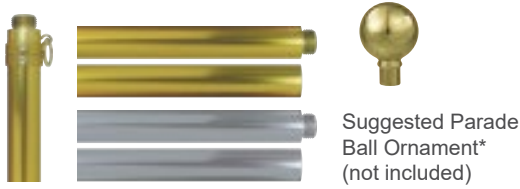

Suggested Parade Ball Ornament* (not included)

POLE INCLUDES:

- Top ornament adapter, cord & tassel ring, flag rings and capped bottom
- 2-piece poles have a precision machined solid brass screw joint

AVAILABLE FINISHES:

- 1" diameter poles are available in silver mill finish OR shiny bright-dipped gold anodized
- 1-1/8" diameter poles are available in shiny bright-dipped silver anodized OR shiny bright-dipped gold anodized

| MODEL | HT. | DIA. | # OF SECTIONS | LBS. | GOLD | | | SILVER | | |
|-------|-----|--------|---------------|------|--------|---------|---------|--------|---------|---------|
| | | | | | ITEM # | 1-11 | 12+ | ITEM # | 1-11 | 12+ |
| P-32 | 6' | 1" | 1 | .90 | 050222 | \$58.50 | \$55.50 | 050240 | \$50.50 | \$47.50 |
| P-33 | 6' | 1" | 2 | 1.1 | 050223 | 89.50 | 86.00 | 050241 | 84.50 | 80.00 |
| P-34 | 6' | 1-1/8" | 1 | 1.4 | 050224 | 74.00 | 72.00 | 050242 | 74.00 | 72.00 |
| P-35 | 6' | 1-1/8" | 2 | 1.5 | 050225 | 108.00 | 105.00 | 050243 | 108.00 | 105.00 |
| P-36 | 7' | 1" | 1 | 1.1 | 050226 | 69.00 | 65.00 | 050244 | 58.50 | 55.50 |
| P-37 | 7' | 1" | 2 | 1.2 | 050227 | 93.00 | 88.50 | 050245 | 89.50 | 86.00 |
| P-38 | 7' | 1-1/8" | 1 | 1.6 | 050228 | 80.00 | 74.00 | 050246 | 80.00 | 74.00 |
| P-46 | 7' | 1-1/8" | 2 | 1.7 | 050229 | 111.00 | 108.00 | 050247 | 111.00 | 108.00 |
| P-39 | 8' | 1" | 1 | 1.2 | 050230 | 71.00 | 68.00 | 050248 | 69.00 | 65.00 |
| P-40 | 8' | 1" | 2 | 1.3 | 050231 | 96.50 | 93.00 | 050249 | 93.00 | 88.50 |
| P-41 | 8' | 1-1/8" | 1 | 1.8 | 050232 | 84.50 | 80.00 | 050250 | 84.50 | 80.00 |
| P-47 | 8' | 1-1/8" | 2 | 1.9 | 050233 | 115.50 | 111.00 | 050251 | 115.50 | 111.00 |
| P-42 | 9' | 1" | 2 | 1.5 | 050234 | 104.00 | 101.00 | 050252 | 96.50 | 93.00 |
| P-48 | 9' | 1-1/8" | 2 | 2.1 | 050235 | 125.00 | 120.50 | 050253 | 125.00 | 120.50 |
| P-44 | 10' | 1" | 2 | 1.6 | 050236 | 107.50 | 104.00 | 050254 | 104.00 | 101.00 |
| P-45 | 10' | 1-1/8" | 2 | 2.3 | 050237 | 125.00 | 120.50 | 050255 | 125.00 | 120.50 |
| P-43 | 11' | 1" | 2 | 1.7 | 050238 | 115.00 | 105.00 | 050256 | 107.50 | 104.00 |
| P-49 | 11' | 1-1/8" | 2 | 2.5 | 050239 | 139.00 | 132.50 | 050257 | 139.00 | 132.50 |

* Compatible ornaments must not include spindle or ferrule.

BUDGET ALUMINUM POLES

Beauty & Economy



POLE INCLUDES:

- Gold plated plastic acorn w/ 3/4" poles
- Gold vinyl ball w/ 1" poles
- Two nylon flag ties
- 2-piece poles swedge together perfectly for a smooth finish

AVAILABLE FINISHES:

- Silver mill OR Shiny gold anodized

| MODEL | HT. | DIA. | # OF SECTIONS | LBS. | GOLD | | | SILVER | | |
|--------|-----|------|---------------|------|--------|---------|---------|--------|---------|---------|
| | | | | | ITEM # | 1-11 | 12+ | ITEM # | 1-11 | 12+ |
| BPA-3 | 6' | 3/4" | 1 | .54 | 050258 | \$34.50 | \$31.00 | 050268 | \$30.00 | \$26.50 |
| BPA-4 | 6' | 3/4" | 2 | .54 | — | — | — | 050269 | 31.00 | 28.50 |
| BPA-5 | 6' | 1" | 1 | .81 | 050260 | 37.50 | 34.50 | 050270 | 34.50 | 31.00 |
| BPA-2 | 6' | 1" | 2 | .81 | 050261 | 39.50 | 37.00 | 050271 | 37.50 | 34.50 |
| BPA-6 | 7' | 1" | 1 | .95 | 050262 | 47.00 | 44.00 | 050272 | 39.50 | 37.00 |
| BPA-7 | 7' | 1" | 2 | .95 | 050263 | 44.50 | 42.50 | 050273 | 37.50 | 34.50 |
| BPA-8 | 8' | 1" | 1 | 1.1 | 050264 | 53.00 | 48.50 | 050274 | 45.50 | 40.50 |
| BPA-1 | 8' | 1" | 2 | 1.1 | 050265 | 51.50 | 48.00 | 050275 | 47.50 | 44.00 |
| BPA-9 | 9' | 1" | 2 | 1.2 | 050266 | 57.00 | 51.50 | 050276 | 51.50 | 48.00 |
| BPA-10 | 10' | 1" | 2 | 1.4 | 050267 | 60.50 | 57.00 | 050277 | 57.00 | 51.50 |

OAK FINISHED POLES

High Quality Grained Hardwood



Suggested Eagle Ornament & Ferrule* (not included)

POLE INCLUDES:

- Cord & tassel ring
- Precision machined solid brass screw joint

| MODEL | HT. | DIA. | # OF SECTIONS | LBS. | w/BRASS JOINT | | | w/CHROME JOINT | | |
|-------|-----|--------|---------------|------|---------------|---------|---------|----------------|----------|----------|
| | | | | | ITEM # | 1-11 | 12+ | ITEM # | 1-11 | 12+ |
| P-10 | 7' | 15/16" | 2 | 1.9 | 050278 | \$83.00 | \$79.00 | 050555 | \$112.50 | \$108.00 |
| P-101 | 7' | 1" | 2 | 1.9 | 050279 | 83.00 | 79.00 | 050556 | 112.50 | 108.00 |
| P-19 | 7' | 1-1/8" | 2 | 2.6 | 050280 | 102.00 | 95.50 | 050557 | 132.00 | 126.50 |
| P-23 | 7' | 1-1/4" | 2 | 3.3 | 050281 | 102.00 | 95.50 | 050558 | 132.00 | 126.50 |
| P-111 | 8' | 1" | 2 | 2.0 | 050283 | 88.50 | 85.50 | 050560 | 120.00 | 116.50 |
| P-20 | 8' | 1-1/8" | 2 | 2.8 | 050284 | 106.50 | 102.00 | 050561 | 138.50 | 131.00 |
| P-24 | 8' | 1-1/4" | 2 | 3.3 | 050285 | 106.50 | 102.00 | 050562 | 138.50 | 131.00 |
| P-21 | 9' | 1-1/8" | 2 | 3.4 | 050286 | 120.00 | 112.50 | 050563 | 151.00 | 142.50 |
| P-25 | 9' | 1-1/4" | 2 | 4.1 | 050287 | 120.00 | 112.50 | 050564 | 151.00 | 142.50 |

* Compatible ornaments must include ferrule.

BUDGET WOODEN POLES

Economy

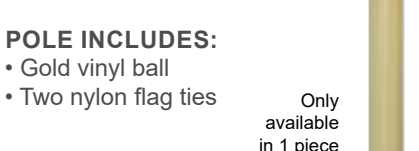

POLE INCLUDES:

- Gold vinyl ball
- Two nylon flag ties

Only available in 1 piece

| MODEL | ITEM # | HEIGHT | DIA. | # OF SECTIONS | 1-11 | 12+ | LBS. |
|-------|--------|--------|--------|---------------|---------|---------|------|
| BP-5 | 050288 | 5' | 15/16" | 1 | \$14.30 | \$13.50 | 1.0 |
| BP-6 | 050289 | 6' | 15/16" | 1 | 17.70 | 16.90 | 1.2 |



Suggested Parade Ball Ornament* (not included)

POLE INCLUDES:

- 2-piece poles have a precision machined solid brass screw joint

AVAILABLE FINISHES:

- 1" diameter poles are available in silver mill OR shiny gold anodized
- 1-1/8" diameter poles are available in shiny silver anodized OR shiny gold anodized



Identical to above poles but supplied with a top cap instead of a top ornament adapter.



ALUMINUM MARCHING BAND POLES

With Top Ornament Adapter & Bottom Plug

| MODEL | HT. | DIA. | # OF SECTIONS | LBS. | GOLD | | | SILVER | | |
|-------|-----|--------|---------------|------|--------|---------|---------|--------|---------|---------|
| | | | | | ITEM # | 1-11 | 12+ | ITEM # | 1-11 | 12+ |
| MP-12 | 6' | 1" | 2 | 1.1 | 050295 | \$93.00 | \$88.50 | 050307 | \$87.50 | \$84.50 |
| MP-15 | 7' | 1" | 1 | .99 | 050298 | 71.00 | 67.50 | 050310 | 61.50 | 58.50 |
| MP-16 | 7' | 1" | 2 | 1.2 | 050299 | 104.00 | 101.00 | 050311 | 92.50 | 90.00 |
| MP-19 | 8' | 1" | 1 | 1.2 | 050302 | 81.50 | 76.00 | 050314 | 72.00 | 69.50 |
| MP-20 | 8' | 1" | 2 | 1.3 | 050303 | 110.50 | 107.50 | 050315 | 103.00 | 100.50 |
| MP-21 | 8' | 1-1/8" | 1 | 1.8 | 050304 | 85.50 | 83.00 | 050316 | 85.50 | 83.00 |

* Compatible ornaments must not include spindle or ferrule.

ALUMINUM MARCHING BAND POLES

With Top Cap & Bottom Plug

| MODEL | HT. | DIA. | # OF SECTIONS | LBS. | GOLD | | | SILVER | | |
|-------|-----|--------|---------------|------|--------|---------|---------|--------|---------|---------|
| | | | | | ITEM # | 1-11 | 12+ | ITEM # | 1-11 | 12+ |
| MP-2 | 6' | 1" | 2 | .92 | 050319 | \$84.50 | \$80.00 | 050331 | \$79.00 | \$73.00 |
| MP-00 | 7' | 1" | 1 | .89 | 050322 | 61.50 | 58.50 | 050334 | 55.50 | 52.50 |
| MP-5 | 7' | 1" | 2 | 1.1 | 050323 | 110.50 | 88.50 | 050335 | 87.50 | 84.50 |
| MP-1 | 8' | 1" | 1 | 1.1 | 050326 | 71.00 | 67.50 | 050338 | 60.50 | 57.00 |
| MP-8 | 8' | 1" | 2 | 1.2 | 050327 | 101.00 | 96.50 | 050339 | 93.50 | 91.50 |
| MP-9 | 8' | 1-1/8" | 1 | 1.7 | 050328 | 74.00 | 72.00 | 050340 | 74.00 | 72.00 |

ADJUSTABLE ALUMINUM POLE

Pole adjusts to any height between 6' and 10' using a tool-free twist-lock setting. Comes with ornament top adapter*, cord & tassel ring, flag rings and capped bottom. Available in shiny gold anodized finish only.

| MODEL | ITEM # | HEIGHT | DIAMETER | 1-11 | 12+ | LBS. |
|--------|--------|----------|----------|---------|---------|------|
| AAP-10 | 050293 | 6' - 10' | 1-1/8" | \$84.50 | \$79.50 | 1.4 |

* Compatible ornaments must not include spindle or ferrule.



WHITE FIBERGLASS MARCHING BAND POLES

Each pole is supplied with a 37" rotating, non-furling sleeve to prevent the flag from tangling around the pole. Comes complete with brass plated plastic acorn ornament.

| MODEL | ITEM # | HT. | DIA. | # OF SECTIONS | 1-11 | 12+ | LBS. |
|--------|--------|-----|------|---------------|---------|---------|------|
| MPF-11 | 050342 | 6' | 1" | 1 | \$65.00 | \$61.50 | 1.7 |
| MPF-12 | 050343 | 8' | 1" | 1 | 72.00 | 68.00 | 2.2 |

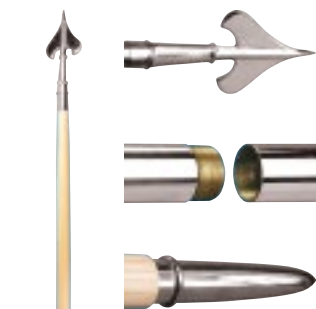

GUIDON POLE SET - WITH 2-SECTION NATURAL OAK FINISH POLE

| WITH SILVER FITTINGS | ITEM # | POLE HT | TOTAL HT* | DIA. | 1-11 | 12+ | LBS. |
|---|--------|---------|-----------|--------|----------|----------|------|
| Each set comes complete with Silver Metal Army Spear, Chrome Plated Brass Screw Joint and Chrome Plated Bottom Ferrule. | 050531 | 7' | 7'-11" | 1-1/4" | \$281.00 | \$265.00 | 3.5 |
| | 050532 | 8' | 8'-11" | 1-1/4" | 298.00 | 281.00 | 3.6 |
| | 050533 | 9' | 9'-11" | 1-1/4" | 315.00 | 300.00 | 4.0 |
| WITH GOLD FITTINGS | ITEM # | HEIGHT | TOTAL HT* | DIA. | 1-11 | 12+ | LBS. |
| Each set comes complete with Brass Plated Metal Army Spear, Brass Plated Screw Joint and Brass Plated Bottom Ferrule. | 050545 | 7' | 7'-11" | 1-1/4" | \$246.00 | \$231.00 | 4.6 |
| | 050546 | 8' | 8'-11" | 1-1/4" | 263.00 | 246.00 | 5.1 |
| | 050547 | 9' | 9'-11" | 1-1/4" | 279.00 | 265.00 | 5.4 |

* Total Height measures from top of ornament to bottom of ferrule.



Chrome Plated

Painted

GUIDON POLE STANDS

These easily movable cast stands come complete with our Guidon Pole Bottom Ferrule Adapter as shown below. The pricing below includes the adapter - no need to order the adapter as a separate item. Not intended for outdoor display.

| ITEM | DESCRIPTION | DIA. | HT. | PRICE | LBS. |
|--------|-----------------------------|------|--------|----------|------|
| 050551 | SILVER CHROME PLATED FINISH | 12" | 4-3/4" | \$472.00 | 14.3 |
| 050552 | SILVER PAINTED FINISH | 12" | 4-3/4" | 306.00 | 15.2 |

GUIDON POLE BOTTOM FERRULE ADAPTER

This injection molded tapered nylon sleeve slips inside of our 1-1/4" B-100 American Beauty, PMB-M Regent and PMB-P Viscount stands to seat the pointed end of the bottom ferrule securely into the floor stand.

| ITEM # | 1-5 | 6+ | LBS. |
|--------|---------|---------|------|
| 050543 | \$34.00 | \$30.50 | .25 |

1-1/8" DIAMETER DELUXE ALUMINUM LEAD PARADE BANNER POLES

- Finish choices include silver mill, or shiny bright-dipped gold anodized.
- End choices include gold spears, capped, or ornament adapter (no ornaments).
- Two piece poles are coupled together with a solid brass, precision-machined screw joint.
- Poles come complete with flag rings.
- Pole length was determined by allowing 6" on each side for hand positions.



| LENGTH | REC. BANNER WIDTH | # OF SECTIONS | WITH CAPPED ENDS | | | | | WITH ORNAMENT ADAPTERS | | | | |
|--------|-------------------|---------------|------------------|---------|------|--------|---------|------------------------|---------|------|--------|---------|
| | | | GOLD | | LBS. | SILVER | | GOLD | | LBS. | SILVER | |
| | | | ITEM # | PRICE | | ITEM # | PRICE | ITEM # | PRICE | | ITEM # | PRICE |
| 36" | 24" | 1 | 050368 | \$45.50 | 1.1 | 050380 | \$45.50 | 050392 | \$76.00 | 1.2 | 050404 | \$76.00 |
| 36" | 24" | 2 | 050369 | 58.50 | 1.4 | 050381 | 58.50 | 050393 | 93.50 | 1.5 | 050405 | 93.50 |
| 48" | 36" | 1 | 050370 | 47.50 | 1.3 | 050382 | 47.50 | 050394 | 82.00 | 1.4 | 050406 | 82.00 |
| 48" | 36" | 2 | 050371 | 68.00 | 1.6 | 050383 | 68.00 | 050395 | 105.00 | 1.7 | 050407 | 105.00 |
| 60" | 48" | 1 | 050372 | 55.00 | 1.5 | 050384 | 55.00 | 050396 | 94.50 | 1.6 | 050408 | 94.50 |
| 60" | 48" | 2 | 050373 | 86.00 | 1.8 | 050385 | 86.00 | 050397 | 113.50 | 1.9 | 050409 | 113.50 |
| 72" | 60" | 1 | 050374 | 62.50 | 1.7 | 050386 | 62.50 | 050398 | 97.50 | 1.8 | 050410 | 97.50 |
| 72" | 60" | 2 | 050375 | 91.50 | 2.0 | 050387 | 91.50 | 050399 | 117.50 | 2.1 | 050411 | 117.50 |
| 84" | 72" | 1 | 050376 | 72.00 | 1.9 | 050388 | 72.00 | 050400 | 100.00 | 2.0 | 050412 | 100.00 |
| 84" | 72" | 2 | 050377 | 100.50 | 2.2 | 050389 | 100.50 | 050401 | 125.50 | 2.3 | 050413 | 125.50 |
| 96" | 84" | 2 | 050378 | 110.00 | 2.4 | 050390 | 110.00 | 050402 | 134.50 | 2.5 | 050414 | 134.50 |
| 108" | 96" | 2 | 050379 | 138.50 | 2.6 | 050391 | 138.50 | 050403 | 162.00 | 2.7 | 050415 | 162.00 |

* When ordering a silver pole, gold ornaments are supplied as standard • Pictured banner not included in above pricing.

1" DIAMETER BUDGET ALUMINUM LEAD PARADE BANNER POLES

- Finish choices include silver mill, or shiny bright-dipped gold anodized.
- Poles come with gold plated plastic acorn ornaments on each end.
- Two piece poles are coupled together with a solid brass, precision-machined screw joint.
- Poles come complete with flag rings.
- Pole length was determined by allowing 2" on each side for the acorn ornaments and 6" on each side for hand positions.



| LENGTH | REC. BANNER WIDTH | # OF SECTIONS | LBS. | GOLD | | SILVER | |
|--------|-------------------|---------------|------|--------|---------|--------|---------|
| | | | | ITEM # | PRICE | ITEM # | PRICE |
| 40" | 24" | 1 | .53 | 050416 | \$38.50 | 050428 | \$34.50 |
| 40" | 24" | 2 | .68 | 050417 | 57.00 | 050429 | 49.50 |
| 52" | 36" | 1 | .65 | 050418 | 42.00 | 050430 | 38.50 |
| 52" | 36" | 2 | .80 | 050419 | 60.50 | 050431 | 58.00 |
| 64" | 48" | 1 | .78 | 050420 | 47.50 | 050432 | 42.00 |
| 64" | 48" | 2 | .93 | 050421 | 58.50 | 050433 | 60.50 |
| 76" | 60" | 1 | .90 | 050422 | 58.00 | 050434 | 45.50 |
| 76" | 60" | 2 | 1.1 | 050423 | 73.00 | 050435 | 58.50 |
| 88" | 72" | 1 | 1.1 | 050424 | 58.50 | 050436 | 60.50 |
| 88" | 72" | 2 | 1.2 | 050425 | 77.50 | 050437 | 65.00 |
| 100" | 84" | 2 | 1.3 | 050426 | 85.50 | 050438 | 80.00 |
| 112" | 96" | 2 | 1.5 | 050427 | 102.00 | 050439 | 93.50 |

• When ordering a silver pole, gold ornaments are supplied as standard.
• Pictured banner not included in above pricing.

15/16" DIAMETER BUDGET WOOD LEAD PARADE BANNER POLES

- Made of hardwood.
- Poles come complete with gold vinyl ball ornaments on each end.
- Pole length was determined by allowing 2" on each side for the ball ornaments and 6" on each side for hand positions.



| ITEM # | MODEL | LENGTH | REC. BANNER WIDTH | # OF SECTIONS | PRICE | LBS. |
|--------|-------|--------|-------------------|---------------|---------|------|
| 050440 | BP36 | 40" | 24" | 1 | \$14.50 | .84 |
| 050441 | BP48 | 52" | 36" | 1 | 16.40 | 1.1 |
| 050442 | BP60 | 64" | 48" | 1 | 17.10 | 1.3 |
| 050443 | BP72 | 72" | 56" | 1 | 18.80 | 1.5 |

• Pictured banner not included in above pricing.



INDOOR & PARADE ACCESSORIES

COLLAPSIBLE ALUMINUM PARADE POLE



| ITEM # | HEIGHT | DIAMETER | 1-11 | 12+ | LBS. |
|--------|-------------|----------|---------|---------|------|
| 050567 | 5' 2" - 10' | 1-1/8" | \$93.50 | \$89.00 | 1.4 |

* Compatible ornaments must not include spindle or ferrule. Recommended for use with 2'x3', 3'x5' or 4'x6' flags.

Pole collapses to 5' 2" with flag still attached, allowing for easy storage. Pole adjusts to any height between 5' 2" and 10' using a tool-free twist-lock setting. Comes with ornament top adapter*, cord & tassel ring, flag rings and capped bottom. Available in shiny gold anodized finish only. Intended for parade use only; not for use in floor stands.

SINGLE STRAP LEATHER CARRYING BELTS



| ITEM # | MODEL | COLOR | 1-11 | 12+ | LBS. |
|--------|---------|-------|----------|----------|------|
| 050446 | B-10 | WHITE | \$111.00 | \$105.00 | .70 |
| 050447 | B-11-BL | BLACK | 93.50 | 87.50 | .70 |

DOUBLE STRAP LEATHER CARRYING BELTS



| ITEM # | MODEL | COLOR | 1-11 | 12+ | LBS. |
|--------|---------|-------|----------|----------|------|
| 050449 | B-12-W | WHITE | \$124.50 | \$120.00 | 1.0 |
| 050450 | B-12-BL | BLACK | 112.50 | 105.00 | 1.0 |

SINGLE STRAP WHITE WEB CARRYING BELT

With Woven Pole Pocket



| ITEM # | MODEL | 1-11 | 12+ | LBS. |
|--------|-------|---------|---------|------|
| 050451 | WWS | \$44.50 | \$43.00 | .27 |

DOUBLE STRAP WHITE WEB CARRYING BELT

With Woven Pole Pocket



| ITEM # | MODEL | 1-11 | 12+ | LBS. |
|--------|-------|---------|---------|------|
| 050452 | WWD | \$57.00 | \$53.00 | .50 |

LEATHERETTE FLAG COVERS

Color May Vary

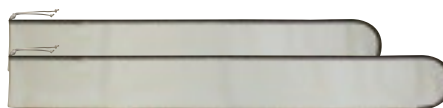

| ITEM # | MODEL | LENGTH | WIDTH | 1-11 | 12+ | LBS. |
|--------|-------|--------|-------|---------|---------|------|
| 050453 | C-10 | 64" | 9" | \$38.50 | \$34.50 | 1.2 |
| 050454 | C-30 | 76" | 9" | 44.50 | 42.00 | 1.5 |

CORD & TASSELS

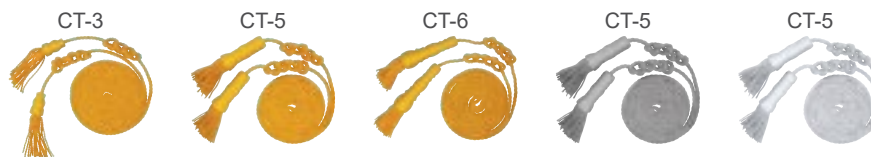

| ITEM # | MODEL | COLOR | FOR FLAG SIZE | TASSEL LENGTH | CORD LENGTH | CORD DIA. | 1-11 | 12+ | LBS. |
|--------|-------|--------|---------------|---------------|-------------|-----------|---------|---------|------|
| 050457 | CT-3 | GOLD | 2' x 3' | 3-1/2" | 108" | 1/4" | \$23.50 | \$22.50 | .07 |
| 050458 | CT-5 | GOLD | 3' x 5' | 4-1/2" | 108" | 5/8" | 30.00 | 27.00 | .15 |
| 050459 | CT-6 | GOLD | 4' x 6' | 6" | 108" | 5/8" | 40.50 | 37.00 | .18 |
| 050469 | CT-5 | SILVER | 3' x 5' | 4-1/2" | 108" | 5/8" | 38.50 | 35.00 | .15 |
| 050470 | CT-5 | WHITE | 3' x 5' | 4-1/2" | 108" | 5/8" | 38.50 | 35.00 | .15 |



BRASS SCREW JOINTS FOR WOOD POLES

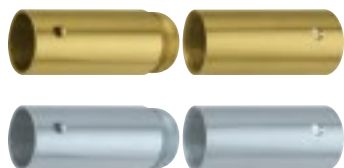

| MODEL | REC. POLE DIA. | OUTSIDE DIA. | INSIDE DIA. | LBS. | POLISHED BRASS | | | CHROME PLATED | | |
|-------|----------------|--------------|-------------|------|----------------|---------|---------|---------------|---------|---------|
| | | | | | ITEM # | 1-11 | 12+ | ITEM # | 1-11 | 12+ |
| BSJ-1 | 15/16" & 1" | 15/16" | 13/16" | .15 | 050471 | \$44.00 | \$40.50 | 050475 | \$72.00 | \$69.50 |
| BSJ-2 | 1-1/8" | 1-1/8" | 31/32" | .40 | 050472 | 52.50 | 49.50 | 050476 | 83.00 | 79.00 |
| BSJ-3 | 1-1/4" | 1-1/4" | 1-3/32" | .50 | 050473 | 52.50 | 49.50 | 050477 | 92.50 | 89.50 |
| BSJ-4 | 1-3/8" | 1-3/8" | 1-7/32" | .50 | 050474 | 93.50 | 91.50 | 050478 | 126.50 | 120.00 |



BRASS SCREW JOINTS

For Aluminum Poles

| ITEM # | FOR POLE DIAMETER | OUTSIDE JOINT DIAMETER | 1-11 | 12+ | LBS. |
|--------|-------------------|------------------------|---------|---------|------|
| 050479 | 1" | 15/16" | \$25.60 | \$25.40 | .15 |
| 050480 | 1-1/8" | 1" | 28.60 | 26.30 | .25 |



BRASS ORNAMENT ADAPTERS

For Aluminum Poles

| ITEM # | FOR POLE DIAMETER | OUTSIDE JOINT DIAMETER | 1-11 | 12+ | LBS. |
|--------|-------------------|------------------------|---------|---------|------|
| 050482 | 1" | 15/16" | \$15.60 | \$14.00 | .07 |
| 050483 | 1-1/8" | 1" | 15.60 | 14.00 | .07 |



BRASS HOOK & EYE

| ITEM # | 1-11 | 12+ | LBS. |
|--------|---------|---------|------|
| 050456 | \$65.00 | \$61.50 | .15 |

Additional charge of \$46.00 for installation and balancing



For Aluminum Poles

For Wood Poles

CORD & TASSEL RINGS

| ITEM # | POLE MATERIAL | OUTSIDE RING DIAMETER | 1-11 | 12+ | LBS. |
|--------|---------------|-----------------------|--------|--------|------|
| 050484 | WOOD | 15/16" | \$4.10 | \$3.40 | .02 |
| 050485 | ALUMINUM | 15/16" | 4.10 | 3.40 | .02 |



For 1" Poles

For 1-1/8" Poles

BLACK PLASTIC BOTTOM PLUGS

For Aluminum Poles

| ITEM # | FOR POLE DIAMETER | OUTSIDE PLUG DIAMETER | 1-11 | 12+ | LBS. |
|--------|-------------------|-----------------------|--------|--------|------|
| 050486 | 1" | 15/16" | \$1.20 | \$1.06 | .01 |
| 050487 | 1-1/8" | 1" | 1.20 | 1.06 | .01 |



PLASTIC BOTTOM PLUG

For Regent & Viscount Floor Stands

| ITEM # | COLOR | 1-11 | 12+ | LBS. |
|--------|-------|--------|--------|------|
| 050499 | BLACK | \$1.24 | \$1.12 | .02 |



STANDARD BRASS FERRULES

For Wood Poles Mounting Screws Included

| ITEM # | FINISH | OUTSIDE DIA. | INSIDE DIA. | 1-11 | 12+ | LBS. |
|--------|--------|--------------|-------------|---------|---------|------|
| 050488 | BRASS | 1" | 7/8" | \$16.20 | \$14.60 | .15 |
| 050489 | CHROME | 1" | 7/8" | 25.00 | 23.20 | .15 |



SPECIAL BRASS FERRULES

For Elks Head Ornament Only
Mounting Screws Included

| ITEM # | FINISH | OUTSIDE DIA. | INSIDE DIA. | 1-11 | 12+ | LBS. |
|--------|--------|--------------|-------------|---------|---------|------|
| 050491 | CHROME | 1" | 7/8" | \$32.50 | \$31.00 | .25 |



5/8"

2-3/4"

1"

ALUMINUM SPINDLE

Silver Only

| ITEM # | 1-11 | 12+ | LBS. |
|--------|--------|--------|------|
| 050492 | \$9.08 | \$8.32 | .10 |



FLOOR STAND SLEEVE ADAPTERS

Plastic

| ITEM # | COLOR | LENGTH | STAND BORE DIA. | FOR POLE DIA. | 1-11 | 12+ | LBS. |
|--------|-------|---------|-----------------|---------------|--------|--------|------|
| 050493 | WHITE | 2" | 1-1/4" | 1-1/8" | \$2.72 | \$2.58 | .02 |
| 050494 | WHITE | 2" | 1-1/8" | 1" | 2.72 | 2.58 | .02 |
| 050495 | WHITE | 4-5/8" | 1-1/4" | 1-1/8" | 2.72 | 2.58 | .04 |
| 050496 | WHITE | 4-5/8" | 1-1/8" | 1" | 2.72 | 2.58 | .03 |
| 050497 | BROWN | 5-3/16" | 1-1/4" | 1-1/8" | 3.18 | 2.86 | .04 |
| 050498 | BROWN | 5-3/16" | 1-1/8" | 1" | 3.18 | 2.86 | .03 |



ALUMINUM FLAG RINGS

For Aluminum Poles

| ITEM # | COLOR | REC. POLE DIA. | OUTSIDE RING DIA. | INSIDE RING DIA. | 1-11 | 12+ | LBS. |
|--------|--------|----------------|-------------------|------------------|--------|--------|------|
| 050500 | GOLD | 1" | 1-1/8" | 1-1/32" | \$5.64 | \$4.92 | .01 |
| 050501 | GOLD | 1-1/8" | 1-1/4" | 1-5/32" | 6.58 | 5.98 | .02 |
| 050502 | SILVER | 1" | 1-1/8" | 1-1/32" | 5.64 | 4.92 | .01 |
| 050503 | SILVER | 1-1/8" | 1-1/4" | 1-5/32" | 6.58 | 5.98 | .02 |

BLACK STYRENE (PLASTIC) TABLE BASES FOR MOUNTED FLAGS



Style # 1

| ITEM # | FOR FLAG SIZE | FOR # OF FLAGS | DIA. | 1-143 | 144-499 | 500+ | LBS. |
|--------|---------------|----------------|--------|--------|---------|--------|------|
| 050504 | 4" x 6" | 1 | 2-1/2" | \$1.22 | \$0.94 | \$0.90 | .025 |
| 050505 | 4" x 6" | 2 | 2-1/2" | 1.92 | 1.58 | 1.40 | .03 |
| 050506 | 4" x 6" | 3 | 2-1/2" | 1.92 | 1.54 | 1.40 | .03 |
| 050507 | 4" x 6" | 4 | 2-1/2" | 2.44 | 2.06 | 1.92 | .03 |
| 050508 | 4" x 6" | 5 | 2-1/2" | 2.44 | 2.06 | 1.92 | .03 |
| 050509 | 4" x 6" | 6 | 2-1/2" | 2.92 | 2.62 | 2.46 | .03 |
| 050510 | 4" x 6" | 7 | 2-1/2" | 2.92 | 2.62 | 2.46 | .03 |

STYRENE (PLASTIC) TABLE BASES FOR MOUNTED FLAGS



Style # 2

| ITEM # | FOR FLAG SIZE | FOR # OF FLAGS | DIA. | COLOR | 1-143 | 144-499 | 500+ | LBS. |
|--------|---------------|----------------|----------|-------|--------|---------|--------|------|
| 050511 | 4" x 6" | 1 | 2-11/16" | GOLD | \$3.12 | \$2.76 | \$2.42 | .05 |
| 050539 | 4" x 6" | 1 | 2-11/16" | BLACK | 1.36 | 1.12 | 1.06 | .05 |

BLACK WOOD TABLE BASES FOR MOUNTED FLAGS



Style # 3

| ITEM # | FOR FLAG SIZE | FOR # OF FLAGS | DIA. | 1-143 | 144+ | LBS. |
|--------|---------------|----------------|--------|---------|---------|------|
| 050513 | 12" x 18" | 1 | 4" | \$17.00 | \$13.80 | .25 |
| 050514 | 12" x 18" | 2 | 5-7/8" | 31.00 | 28.50 | .70 |

BLACK WOOD TABLE BASES FOR MOUNTED FLAGS



Style # 5

| ITEM # | FOR FLAG SIZE | FOR # OF FLAGS | DIA. | 1-143 | 144+ | LBS. |
|--------|---------------|----------------|--------|--------|--------|------|
| 050516 | 8" x 12" | 1 | 2-1/8" | \$6.80 | \$5.70 | .13 |
| 050517 | 8" x 12" | 2 | 2-1/2" | 10.90 | 9.90 | .11 |

WALNUT WOOD TABLE BASES



| ITEM # | FOR FLAG SIZE | FOR # OF FLAGS | WIDTH | DEPTH | 1-143 | 144+ | LBS. |
|--------|---------------|----------------|-------|-------|--------|--------|------|
| 050528 | 4" x 6" | 1 | 3" | 2" | \$8.30 | \$7.30 | .08 |
| 050529 | 4" x 6" | 2 | 3" | 2" | 8.30 | 7.30 | .08 |

Flags pictured below not included in above pricing.



EVOLUTION OF OLD GLORY

Shown here are the 27 legal flags flown throughout our history, with effective date(s) and state addition(s) that changed the star field.

By law, a star is added to the U.S. Flag on the 4th of July following the admission of a State(s) to the Union.

Contrary to popular belief, the first official U.S. Flag was not the Betsy Ross Flag (13 stars in a circle) but the staggered star pattern shown in the below 13-star flag.

It is important to note that no U.S. Flag ever becomes obsolete. Each flag shown is still a legal flag and may be flown at any time.

| # OF STARS | 3' x 5' NYLON OUTDOOR APPLIQUED FIELD SEWN STRIPES (Weight .65 lbs) | | 4' x 6" NYLON OUTDOOR APPLIQUED FIELD SEWN STRIPES (Weight 1.0 lbs) | | 5' x 8" NYLON OUTDOOR APPLIQUED FIELD SEWN STRIPES (Weight 1.4 lbs) | |
|------------|---|---------|---|---------|---|----------|
| | ITEM # | PRICE | ITEM # | PRICE | ITEM # | PRICE |
| 13 | 060026 | \$90.00 | 060104 | \$99.00 | 060182 | \$132.00 |
| 15 | 060027 | 95.00 | 060105 | 103.50 | 060183 | 139.00 |
| 20 | 060028 | 101.50 | 060106 | 108.50 | 060184 | 146.00 |
| 21 | 060029 | 107.50 | 060107 | 116.00 | 060185 | 157.00 |
| 23 | 060030 | 112.00 | 060108 | 119.50 | 060186 | 161.00 |
| 24 | 060031 | 115.00 | 060109 | 124.00 | 060187 | 163.00 |
| 25 | 060032 | 116.00 | 060110 | 125.50 | 060188 | 166.00 |
| 26 | 060033 | 118.50 | 060111 | 129.00 | 060189 | 169.00 |
| 27 | 060034 | 119.50 | 060112 | 130.50 | 060190 | 171.00 |
| 28 | 060035 | 124.00 | 060113 | 132.50 | 060191 | 175.00 |
| 29 | 060036 | 126.50 | 060114 | 134.00 | 060192 | 176.00 |
| 30 | 060037 | 129.00 | 060115 | 136.50 | 060193 | 180.00 |
| 31 | 060038 | 131.50 | 060116 | 138.50 | 060194 | 184.00 |
| 32 | 060039 | 132.50 | 060117 | 141.00 | 060195 | 185.00 |
| 33 | 060040 | 135.50 | 060118 | 143.50 | 060196 | 187.00 |
| 34 | 060041 | 136.50 | 060119 | 145.00 | 060197 | 191.00 |
| 35 | 060042 | 140.00 | 060120 | 149.00 | 060198 | 195.00 |
| 36 | 060043 | 141.00 | 060121 | 150.00 | 060199 | 199.00 |
| 37 | 060044 | 143.50 | 060122 | 152.50 | 060200 | 202.00 |
| 38 | 060045 | 145.00 | 060123 | 155.00 | 060201 | 204.00 |
| 43 | 060046 | 150.00 | 060124 | 166.50 | 060202 | 216.00 |
| 44 | 060047 | 152.50 | 060125 | 170.00 | 060203 | 220.00 |
| 45 | 060048 | 155.00 | 060126 | 171.00 | 060204 | 222.00 |
| 46 | 060049 | 156.50 | 060127 | 173.00 | 060205 | 225.00 |
| 48 | 060050 | 161.50 | 060128 | 177.50 | 060206 | 230.00 |
| 49 | 060051 | 164.50 | 060129 | 179.50 | 060207 | 232.00 |
| 50 | SEE PAGES 2 THROUGH 13 | | | | | |

* 4' x 6" and 5' x 8" flags are made to order. Please allow up to two weeks for shipment.



13 STARS
1777-1795 (CT, DE, GA, MD, MA, NH, NJ, NY, NC, PA, RI, SC, VA)



15 STARS
1795-1818 (KY, VT)



20 STARS
1818-1819 (IN, LA, MS, OH, TN)



21 STARS
1819-1820 (IL)



23 STARS
1820-1822 (AL, ME)

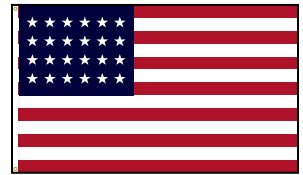

24 STARS
1822-1836 (MO)



25 STARS
1836-1837 (AR)

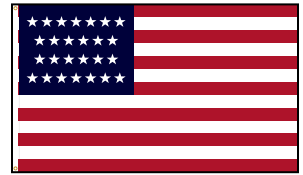

26 STARS
1837-1845 (MI)



27 STARS
1845-1846 (FL)



28 STARS
1846-1847 (TX)



29 STARS
1847-1848 (IA)



30 STARS
1848-1851 (WI)



31 STARS
1851-1858 (CA)



32 STARS
1858-1859 (MN)



33 STARS
1859-1861 (OR)



34 STARS
1861-1863 (KS)



35 STARS
1863-1865 (WV)



36 STARS
1865-1867 (NV)

U.S. HISTORICAL FLAGS

EVOLUTION OF OLD GLORY



37 STARS
1867-1877
(NE)

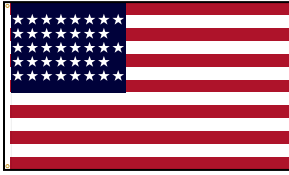

38 STARS
1877-1890
(CO)



43 STARS
1890-1891
(ID, MT, ND, SD, WA)

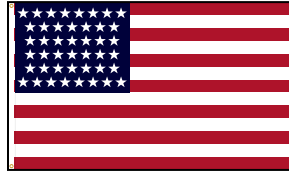

44 STARS
1891-1896
(WY)



45 STARS
1896-1908
(UT)



46 STARS
1908-1912
(OK)

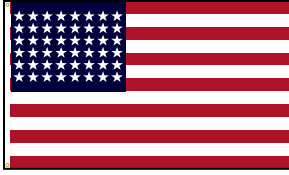

48 STARS
1912-1959
(AZ, NM)



49 STARS
1959-1960
(AK)

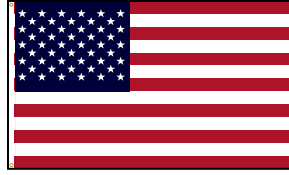

50 STARS
1960-present
(HI)



**BENNINGTON
FLAGS**

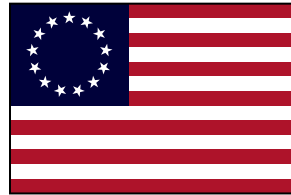

BETSY ROSS FLAGS

| ITEM # | SIZE | MOUNTED | 1-11 DOZ [♦] | 12+ DOZ [♦] | LBS. |
|--------|-----------|------------|-----------------------|----------------------|------|
| 060695 | 4" x 6" | E-GLOSS | \$31.20 | \$28.08 | .36 |
| ITEM # | SIZE | FULLY SEWN | 1-5 | 6+ | LBS. |
| 060714 | 3' x 5' * | O/D NYLON | \$58.00 | \$54.50 | .60 |

*SOLD BY THE DOZEN

GADSDEN FLAGS

The Gadsden flag and other rattlesnake flags were widely used during the American Revolution. There was no standard American flag at the time. The Gadsden flag was first used in February 1776. The flag depicts a rattlesnake in the attitude of going to strike with the words 'DONT TREAD ON ME' underneath.



| ITEM # | SIZE | MOUNTED | 1-143 | 144+ | LBS. |
|--------|-----------|---------|---------|---------|------|
| 060745 | 12" x 18" | E-POLY | \$4.80 | \$4.20 | .08 |
| ITEM # | SIZE | OUTDOOR | 1-5 | 6+ | LBS. |
| 060504 | 3' x 5' | E-POLY | \$29.00 | \$25.50 | .27 |
| 060566 | 3' x 5' | NYLON | 63.00 | 57.00 | .45 |
| 060742 | 4' x 6' | NYLON | 92.50 | — | .70 |
| 060743 | 5' x 8' | NYLON | 128.00 | — | 1.0 |
| 060744 | 6' x 10' | NYLON | 227.00 | — | 1.8 |

| ITEM # | SIZE | ANILINE DYED | 1-5 | 6+ | LBS. |
|--------|-----------|--------------|---------|---------|------|
| 060666 | 2' x 3' | O/D NYLON | \$35.10 | \$34.00 | .25 |
| 060667 | 3' x 5' | O/D NYLON | 61.00 | 58.00 | .45 |
| ITEM # | SIZE | FULLY SEWN | 1-5 | 6+ | LBS. |
| 060700 | 2' x 3' * | O/D NYLON | \$53.50 | \$51.50 | .35 |
| 060701 | 3' x 5' * | O/D NYLON | 50.00 | 49.00 | .60 |
| 060702 | 4' x 6' * | O/D NYLON | 71.00 | 64.00 | .85 |
| 060703 | 5' x 8' * | O/D NYLON | 117.00 | 111.00 | 1.4 |

* 2' x 3' and 3' x 5' flags are supplied with embroidered star fields.
4' x 6' and 5' x 8' flags are supplied with applied star fields.

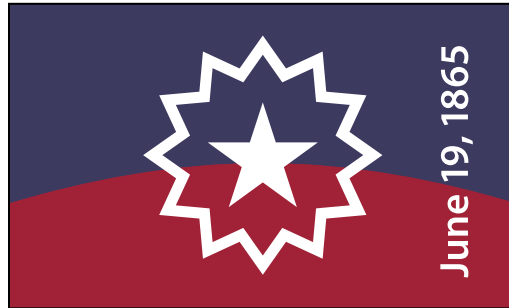

JUNETEENTH

| ITEM # | SIZE | OUTDOOR | 1-5 | 6+ | LBS. |
|--------|---------|---------|---------|---------|------|
| 060748 | 3' x 5' | NYLON | \$63.00 | \$57.00 | .45 |



ALAMO

| ITEM # | 1-5 | 6+ | LBS. |
|--------|---------|---------|------|
| 060545 | \$63.00 | \$57.00 | .45 |

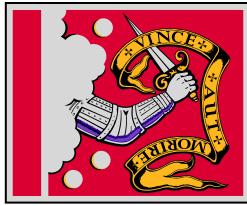

BEDFORD

| ITEM # | 1-5 | 6+ | LBS. |
|--------|---------|---------|------|
| 060546 | \$72.50 | \$65.50 | .45 |

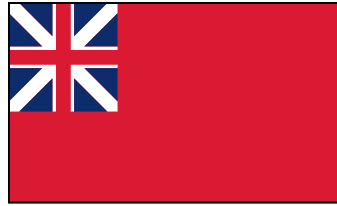

BRITISH RED ENSIGN

| ITEM # | 1-5 | 6+ | LBS. |
|--------|---------|---------|------|
| 060547 | \$62.00 | \$55.00 | .45 |

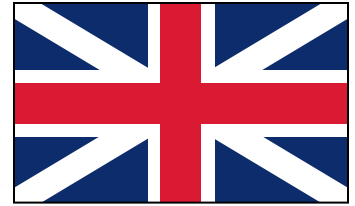

BRITISH UNION

| ITEM # | 1-5 | 6+ | LBS. |
|--------|---------|---------|------|
| 060548 | \$62.00 | \$55.00 | .45 |

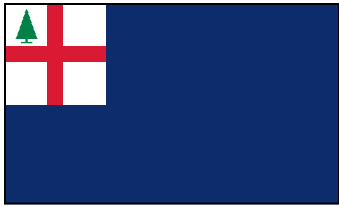

BUNKER HILL

| ITEM # | 1-5 | 6+ | LBS. |
|--------|---------|---------|------|
| 060549 | \$63.00 | \$57.00 | .45 |



CALIFORNIA REPUBLIC

| ITEM # | 1-5 | 6+ | LBS. |
|--------|---------|---------|------|
| 060550 | \$63.00 | \$57.00 | .45 |

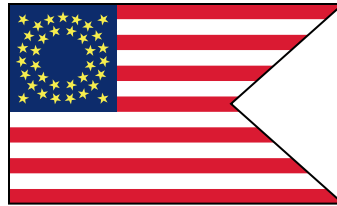

CAVALRY GUIDON

| ITEM # | 1-5 | 6+ | LBS. |
|--------|---------|---------|------|
| 060741 | \$62.00 | \$55.00 | .45 |

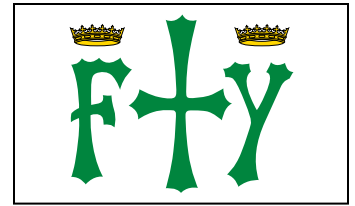

COLUMBUS

| ITEM # | 1-5 | 6+ | LBS. |
|--------|---------|---------|------|
| 060552 | \$63.00 | \$57.00 | .45 |

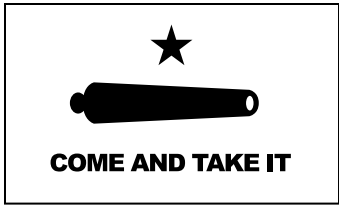

COME & TAKE IT

| ITEM # | 1-5 | 6+ | LBS. |
|--------|---------|---------|------|
| 060553 | \$63.00 | \$57.00 | .45 |



COMMODORE PERRY

| ITEM # | 1-5 | 6+ | LBS. |
|--------|---------|---------|------|
| 060554 | \$63.00 | \$57.00 | .45 |



CONTINENTAL

| ITEM # | 1-5 | 6+ | LBS. |
|--------|---------|---------|------|
| 060555 | \$62.00 | \$55.00 | .45 |

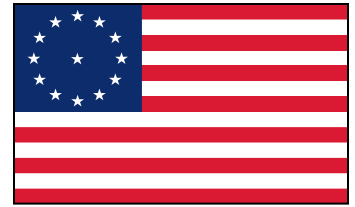

COWPENS

| ITEM # | 1-5 | 6+ | LBS. |
|--------|---------|---------|------|
| 060556 | \$62.00 | \$55.00 | .45 |

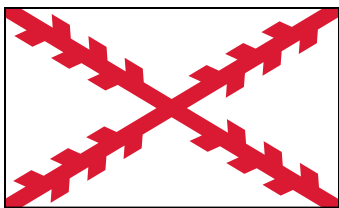

CROSS OF BURGUNDY

| ITEM # | 1-5 | 6+ | LBS. |
|--------|---------|---------|------|
| 060557 | \$62.00 | \$55.00 | .45 |

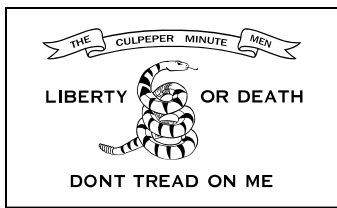

CULPEPER

| ITEM # | 1-5 | 6+ | LBS. |
|--------|---------|---------|------|
| 060559 | \$63.00 | \$57.00 | .45 |



1st NAVY JACK

| ITEM # | 1-5 | 6+ | LBS. |
|--------|---------|---------|------|
| 060561 | \$63.00 | \$57.00 | .45 |



FLEUR-DE-LIS (BLUE-3)

| ITEM # | 1-5 | 6+ | LBS. |
|--------|---------|---------|------|
| 060562 | \$62.00 | \$55.00 | .45 |

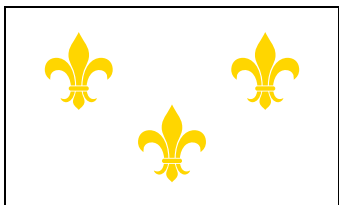

FLEUR-DE-LIS (WHITE-3)

| ITEM # | 1-5 | 6+ | LBS. |
|--------|---------|---------|------|
| 060563 | \$63.00 | \$57.00 | .45 |

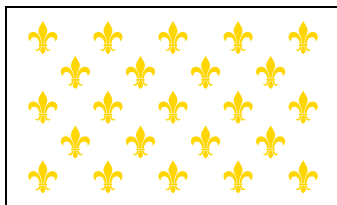

FLEUR-DE-LIS (WHITE-23)

| ITEM # | 1-5 | 6+ | LBS. |
|--------|---------|---------|------|
| 060564 | \$63.00 | \$57.00 | .45 |



FORT MOULTRIE

| ITEM # | 1-5 | 6+ | LBS. |
|--------|---------|---------|------|
| 060565 | \$63.00 | \$57.00 | .45 |

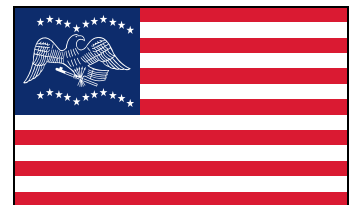

GENERAL FREMONT

| ITEM # | 1-5 | 6+ | LBS. |
|--------|---------|---------|------|
| 060567 | \$62.00 | \$55.00 | .45 |

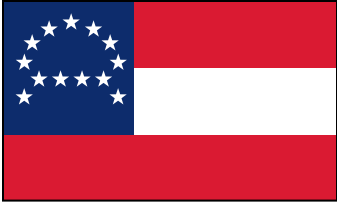

GENERAL LEE'S HEADQUARTERS

| ITEM # | 1-5 | 6+ | LBS. |
|--------|---------|---------|------|
| 060739 | \$62.00 | \$55.00 | .45 |

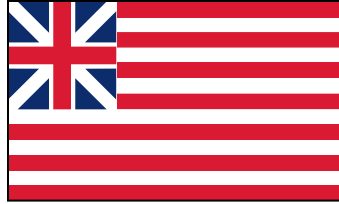

GRAND UNION

| ITEM # | 1-5 | 6+ | LBS. |
|--------|---------|---------|------|
| 060568 | \$62.00 | \$55.00 | .45 |

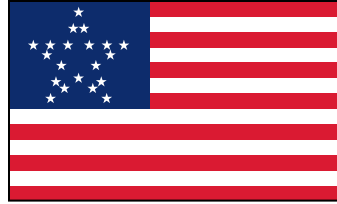

GREAT STAR

| ITEM # | 1-5 | 6+ | LBS. |
|--------|---------|---------|------|
| 060569 | \$62.00 | \$55.00 | .45 |



GREEN MOUNTAIN BOYS

| ITEM # | 1-5 | 6+ | LBS. |
|--------|---------|---------|------|
| 060570 | \$62.00 | \$55.00 | .45 |

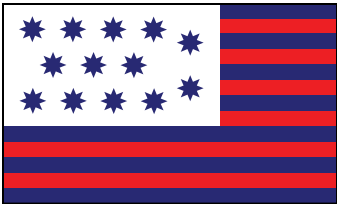

GUILFORD COURTHOUSE

| ITEM # | 1-5 | 6+ | LBS. |
|--------|---------|---------|------|
| 060571 | \$62.00 | \$55.00 | .45 |



LORD BALTIMORE

| ITEM # | 1-5 | 6+ | LBS. |
|--------|---------|---------|------|
| 060572 | \$62.00 | \$55.00 | .45 |

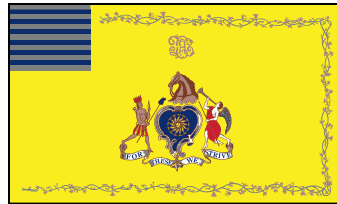

PHILADELPHIA LIGHT HORSE TROOP

| ITEM # | 1-5 | 6+ | LBS. |
|--------|---------|---------|------|
| 060573 | \$72.50 | \$65.50 | .45 |

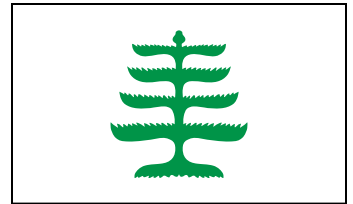

PINE TREE

| ITEM # | 1-5 | 6+ | LBS. |
|--------|---------|---------|------|
| 060574 | \$63.00 | \$57.00 | .45 |

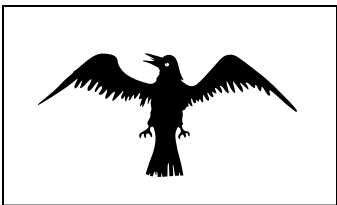

RAVEN

| ITEM # | 1-5 | 6+ | LBS. |
|--------|---------|---------|------|
| 060575 | \$63.00 | \$57.00 | .45 |



RHODE ISLAND REGIMENT

| ITEM # | 1-5 | 6+ | LBS. |
|--------|---------|---------|------|
| 060576 | \$62.00 | \$55.00 | .45 |

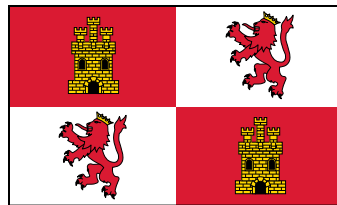

ROYAL STANDARD OF SPAIN

| ITEM # | 1-5 | 6+ | LBS. |
|--------|---------|---------|------|
| 060577 | \$63.00 | \$57.00 | .45 |



RUSSIAN AMERICAN COMPANY

| ITEM # | 1-5 | 6+ | LBS. |
|--------|---------|---------|------|
| 060578 | \$72.50 | \$65.50 | .45 |



SERAPIS

| ITEM # | 1-5 | 6+ | LBS. |
|--------|---------|---------|------|
| 060579 | \$62.00 | \$55.00 | .45 |

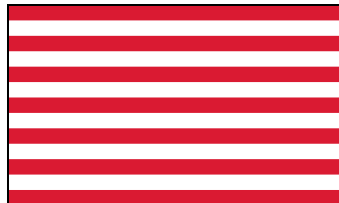

SONS OF LIBERTY

| ITEM # | 1-5 | 6+ | LBS. |
|--------|---------|---------|------|
| 060580 | \$63.00 | \$57.00 | .45 |

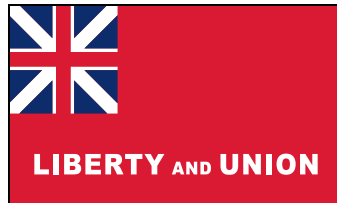

TAUNTON

| ITEM # | 1-5 | 6+ | LBS. |
|--------|---------|---------|------|
| 060581 | \$62.00 | \$55.00 | .45 |



UNION CIVIL WAR

| ITEM # | 1-5 | 6+ | LBS. |
|--------|---------|---------|------|
| 060582 | \$62.00 | \$55.00 | .45 |



WASHINGTON'S COMMANDER-IN-CHIEF

| ITEM # | 1-5 | 6+ | LBS. |
|--------|---------|---------|------|
| 060740 | \$63.00 | \$57.00 | .45 |



AN APPEAL TO HEAVEN

WASHINGTON'S CRUISERS

| ITEM # | 1-5 | 6+ | LBS. |
|--------|---------|---------|------|
| 060584 | \$63.00 | \$57.00 | .45 |

4" X 6" E-GLOSS MOUNTED U.S. HISTORICAL FLAGS

- Brilliantly printed on silk-like material.
- Hemmed on all four sides.
- Flags mounted on a 3/16" x 10" black plastic staff with gold spear.
- Highest quality mounted flag.
- *Ideal for desktop display.*

| U.S. HISTORICAL | ITEM # |
|-----------------------|--------|
| WASHINGTON'S CRUISERS | 060465 |

| SIZE | 1-11 DOZEN* | 12+ DOZEN* | LBS. |
|---------|-------------|------------|------|
| 4" x 6" | \$31.20 | \$28.08 | .36 |

*SOLD BY THE DOZEN

ARMED FORCES INDOOR/PARADE FLAGS



See [page 63](#) for updated version of the Air Force flag

See [pages 10-11](#) for mounting sets only and [pages 48-49](#) for ornament options. Flags shown with Oak Poles, ABS Spear and Endura Stand.

FLAGS W/ POLE HEM ONLY

| ITEM # | SIZE | STYLE | FLAG | 1-5 | 6+ | LBS. |
|--------|---------|-------|--------------|---------|---------|------|
| 070058 | 3' x 5' | NYLON | ARMY | \$70.10 | \$65.40 | .40 |
| 070060 | 3' x 5' | NYLON | MARINE CORPS | 70.10 | 65.40 | .40 |
| 070061 | 3' x 5' | NYLON | NAVY | 70.10 | 65.40 | .40 |
| 070057 | 3' x 5' | NYLON | AIR FORCE | 70.10 | 65.40 | .40 |
| 070059 | 3' x 5' | NYLON | COAST GUARD | 70.10 | 65.40 | .40 |
| 070156 | 3' x 5' | NYLON | POW-MIA | 70.10 | 65.40 | .40 |

FLAGS W/ POLE HEM AND FRINGE

| ITEM # | SIZE | STYLE | FLAG | 1-5 | 6+ | LBS. |
|--------|---------|-------|--------------|---------|---------|------|
| 070063 | 3' x 5' | NYLON | ARMY | \$91.10 | \$86.40 | .60 |
| 070065 | 3' x 5' | NYLON | MARINE CORPS | 91.10 | 86.40 | .60 |
| 070066 | 3' x 5' | NYLON | NAVY | 91.10 | 86.40 | .60 |
| 070062 | 3' x 5' | NYLON | AIR FORCE | 91.10 | 86.40 | .60 |
| 070064 | 3' x 5' | NYLON | COAST GUARD | 91.10 | 86.40 | .60 |
| 070151 | 3' x 5' | NYLON | POW-MIA* | 91.10 | 86.40 | .60 |

*Silver fringe will be used for POW-MIA flags unless gold is specified.



MARINE CORPS



NAVY

ARMED FORCES RETIREMENT FLAGS

Endura-Poly™ With White Header & Brass Grommets

| ITEM # | SIZE | DESCRIPTION | 1-5 | 6+ | LBS. |
|--------|---------|----------------------|---------|---------|------|
| 070188 | 3' x 4' | AIR FORCE RETIRED | \$24.00 | \$22.00 | .32 |
| 070190 | 3' x 5' | COAST GUARD RETIRED | 23.90 | 21.50 | .35 |
| 070191 | 3' x 5' | MARINE CORPS RETIRED | 23.90 | 21.50 | .35 |
| 070193 | 3' x 5' | NAVY RETIRED | 24.00 | 22.00 | .35 |



AIR FORCE



COAST GUARD

ARMY



3' x 5' Nylon



4" x 6" Endura-Gloss

OUTDOOR ARMY FLAGS

| ITEM # | SIZE | STYLE | 1-5 | 6+ | LBS. |
|--------|-----------|----------|---------|---------|------|
| 070006 | 12" x 18" | NYLON | \$20.70 | \$18.60 | .10 |
| 070023 | 2' x 3' | NYLON | 36.20 | 34.80 | .25 |
| 070053 | 3' x 5' | NYLON | 49.10 | 44.40 | .45 |
| 070068 | 4' x 6' | NYLON | 88.50 | 81.00 | .70 |
| 070083 | 5' x 8' | NYLON | 123.00 | 114.00 | 1.0 |
| 070376 | 6' x 10' | NYLON | 283.00 | — | 1.8 |
| 070406 | 3' x 5' | POLY MAX | 104.00 | 91.50 | .65 |
| 070011 | 2' x 3' | E-POLY | 19.80 | 16.80 | .15 |
| 070038 | 3' x 5' | E-POLY | 23.90 | 21.50 | .35 |

Officially Licensed Manufacturer for the United States Army

MOUNTED ARMY FLAGS

| ITEM # | SIZE | MATERIAL | STAFF SIZE | STAFF MATERIAL | STAFF COLOR | 1-143 | 144+ | LBS. |
|--------|---------|----------|-------------|----------------|-------------|--------|--------|------|
| 070108 | 4" x 6" | PLASTIC | 3/16" x 10" | PLASTIC | GOLD | \$0.58 | \$0.50 | .02 |

MARINE CORPS



3' x 5' Nylon

OUTDOOR MARINE CORPS FLAGS

| ITEM # | SIZE | STYLE | 1-5 | 6+ | LBS. |
|--------|-----------|-------------|---------|---------|------|
| 070008 | 12" x 18" | NYLON | \$20.70 | \$18.60 | .10 |
| 070025 | 2' x 3' | NYLON | 47.50 | 45.80 | .25 |
| 070055 | 3' x 5' | NYLON | 49.10 | 44.40 | .45 |
| 070070 | 4' x 6' | NYLON | 103.00 | 92.50 | .70 |
| 070085 | 5' x 8' | NYLON | 139.00 | 132.00 | 1.0 |
| 070378 | 6' x 10' | NYLON | 283.00 | — | 1.8 |
| 070408 | 3' x 5' | POLY MAX | 104.00 | 91.50 | .65 |
| 070040 | 3' x 5' | POLY-COTTON | 23.90 | 21.50 | .35 |

Officially Licensed Manufacturer for the United States Marine Corps

NAVY



3' x 5' Nylon



4" x 6" Endura-Gloss

OUTDOOR NAVY FLAGS

| ITEM # | SIZE | STYLE | 1-5 | 6+ | LBS. |
|--------|-----------|-------------|---------|---------|------|
| 070009 | 12" x 18" | NYLON | \$20.70 | \$18.60 | .10 |
| 070026 | 2' x 3' | NYLON | 61.50 | 59.70 | .25 |
| 070056 | 3' x 5' | NYLON | 49.10 | 44.40 | .45 |
| 070071 | 4' x 6' | NYLON | 119.50 | 114.00 | .70 |
| 070086 | 5' x 8' | NYLON | 171.00 | 163.00 | 1.0 |
| 070379 | 6' x 10' | NYLON | 283.00 | — | 1.8 |
| 070407 | 3' x 5' | POLY MAX | 104.00 | 91.50 | .65 |
| 070004 | 12" x 18" | E-POLY | 10.50 | 9.30 | .05 |
| 070013 | 2' x 3' | E-POLY | 19.80 | 16.80 | .15 |
| 070041 | 3' x 5' | POLY-COTTON | 23.90 | 21.50 | .35 |

MOUNTED NAVY FLAGS

| ITEM # | SIZE | MATERIAL | STAFF SIZE | STAFF MATERIAL | STAFF COLOR | 1-143 | 144+ | LBS. |
|--------|-----------|----------|-------------|----------------|-------------|--------|--------|------|
| 070111 | 4" x 6" | PLASTIC | 3/16" x 10" | PLASTIC | GOLD | \$0.58 | \$0.50 | .02 |
| 070126 | 12" x 18" | E-POLY | 5/16" x 30" | WOOD | NATURAL | 5.70 | 5.20 | .08 |

AIR FORCE



3' x 5' Nylon

OUTDOOR AIR FORCE FLAGS

| ITEM # | SIZE | STYLE | 1-5 | 6+ | LBS. |
|--------|-----------|----------|---------|---------|------|
| 070005 | 12" x 18" | NYLON | \$20.70 | \$18.60 | .10 |
| 070022 | 2' x 3' | NYLON | 52.90 | 51.40 | .25 |
| 070052 | 3' x 5' | NYLON | 49.10 | 44.40 | .45 |
| 070067 | 4' x 6' | NYLON | 112.00 | 101.50 | .70 |
| 070082 | 5' x 8' | NYLON | 145.00 | 143.00 | 1.0 |
| 070375 | 6' x 10' | NYLON | 283.00 | — | 1.8 |
| 070409 | 3' x 5' | POLY MAX | 104.00 | 91.50 | .65 |
| 070010 | 2' x 3' | E-POLY | 19.80 | 16.80 | .15 |
| 070037 | 3' x 5' | E-POLY | 23.90 | 21.50 | .35 |

Officially Licensed Manufacturer for the United States Air Force

COAST GUARD



3' x 5' Nylon

OUTDOOR COAST GUARD FLAGS

| ITEM # | SIZE | STYLE | 1-5 | 6+ | LBS. |
|--------|-----------|----------|---------|---------|------|
| 070007 | 12" x 18" | NYLON | \$20.70 | \$18.60 | .10 |
| 070024 | 2' x 3' | NYLON | 36.20 | 34.80 | .25 |
| 070054 | 3' x 5' | NYLON | 49.10 | 44.40 | .45 |
| 070069 | 4' x 6' | NYLON | 88.50 | 81.00 | .70 |
| 070084 | 5' x 8' | NYLON | 123.00 | 114.00 | 1.0 |
| 070377 | 6' x 10' | NYLON | 283.00 | — | 1.8 |
| 070410 | 3' x 5' | POLY MAX | 104.00 | 91.50 | .65 |
| 070039 | 3' x 5' | E-POLY | 23.90 | 21.50 | .35 |



4" x 6" Endura-Gloss

MOUNTED COAST GUARD FLAGS

| ITEM # | SIZE | MATERIAL | STAFF SIZE | STAFF MATERIAL | STAFF COLOR | 1-143 | 144+ | LBS. |
|--------|-----------|----------|-------------|----------------|-------------|--------|--------|------|
| 070109 | 4" x 6" | PLASTIC | 3/16" x 10" | PLASTIC | GOLD | \$0.58 | \$0.50 | .02 |
| 070124 | 12" x 18" | E-POLY | 5/16" x 30" | WOOD | NATURAL | 5.70 | 5.20 | .08 |

OUTDOOR AIR FORCE LOGO FLAG



| ITEM # | SIZE | STYLE | 1-5 | 6+ | LBS. |
|--------|---------|-------|---------|---------|------|
| 070483 | 3' x 5' | NYLON | \$49.10 | \$44.40 | .45 |

Officially Licensed Manufacturer for the United States Air Force

OUTDOOR SPACE FORCE LOGO FLAGS

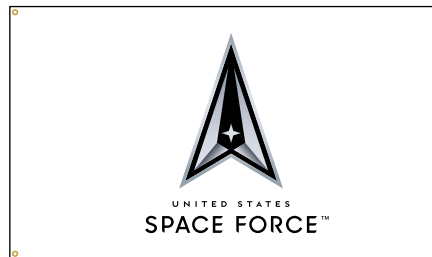

| ITEM # | SIZE | COLOR | STYLE | 1-5 | 6+ | LBS. |
|--------|---------|-------|-------|---------|---------|------|
| 070484 | 3' x 5' | WHITE | NYLON | \$49.10 | \$44.40 | .45 |
| 070485 | 3' x 5' | BLACK | NYLON | 49.10 | 44.40 | .45 |

Officially Licensed Manufacturer for the United States Space Force

POW-MIA



3' x 5' Nylon



OUTDOOR POW-MIA FLAGS (SINGLE FACE)

With Canvas Header & Brass Grommets



FRONT SIDE



BACK SIDE

| ITEM # | SIZE | STYLE | 1-5 | 6+ | LBS. |
|--------|-----------|-------------|---------|---------|------|
| 070136 | 12" x 18" | NYLON | \$20.70 | \$18.60 | .10 |
| 070138 | 2' x 3' | NYLON | 31.80 | 29.00 | .25 |
| 070140 | 3' x 5' | NYLON | 49.10 | 44.40 | .45 |
| 070141 | 4' x 6' | NYLON | 88.00 | 80.00 | .70 |
| 070142 | 5' x 8' | NYLON | 123.00 | 111.00 | 1.0 |
| 070143 | 6' x 10' | NYLON | 175.00 | 159.00 | 1.7 |
| 070423 | 8' x 12' | NYLON | 305.00 | 263.00 | 3.2 |
| 070399 | 3' x 5' | POLY MAX | 58.50 | 53.00 | .65 |
| 070400 | 4' x 6' | POLY MAX | 95.00 | 90.00 | .95 |
| 070401 | 5' x 8' | POLY MAX | 168.00 | 164.00 | 1.5 |
| 070137 | 2' x 3' | E-POLY | 19.80 | 16.80 | .15 |
| 070139 | 3' x 5' | POLY-COTTON | 29.00 | 25.50 | .35 |

OUTDOOR POW-MIA FLAGS (DOUBLE FACE)

With Canvas Header & Brass Grommets



FRONT SIDE



BACK SIDE

| ITEM # | SIZE | STYLE | 1-5 | 6+ | LBS. |
|--------|-----------|----------|---------|---------|------|
| 070144 | 12" x 18" | NYLON | \$41.40 | \$37.40 | .17 |
| 070145 | 2' x 3' | NYLON | 45.40 | 41.10 | .35 |
| 070146 | 3' x 5' | NYLON | 77.50 | 73.00 | .60 |
| 070147 | 4' x 6' | NYLON | 94.00 | 91.00 | 1.0 |
| 070148 | 5' x 8' | NYLON | 163.00 | 157.00 | 1.5 |
| 070149 | 6' x 10' | NYLON | 209.00 | 201.00 | 2.2 |
| 070424 | 8' x 12' | NYLON | 392.00 | 364.00 | 3.9 |
| 070403 | 3' x 5' | POLY MAX | 102.50 | 100.50 | 1.2 |
| 070404 | 4' x 6' | POLY MAX | 125.50 | 120.50 | 1.8 |
| 070405 | 5' x 8' | POLY MAX | 234.00 | 232.00 | 2.5 |

See [page 16](#) for pricing add-ons for pole hem & fringe flags and pole hem only flags. Silver fringe will be used for POW-MIA flags unless gold is specified.

MOUNTED POW-MIA FLAGS

With Gold Spears



4" x 6"
Endura-Gloss

| ITEM # | SIZE | FLAG MATERIAL | STAFF SIZE, COLOR & MATERIAL | 1-143 | 144+ | LBS. |
|--------|-----------|--------------------|------------------------------|--------|--------|------|
| 070171 | 4" x 6" | LIGHTWEIGHT COTTON | 3/16" x 10" NATURAL WOOD | \$1.52 | \$1.22 | .02 |
| 070172 | 4" x 6" | NO-FRAY COTTON | 3/16" x 10" NATURAL WOOD | 1.22 | 0.86 | .02 |
| 070416 | 8" x 12" | E-GLOSS | 1/4" x 18" BLACK WOOD | 10.60 | 7.60 | .05 |
| 070174 | 12" x 18" | E-POLY | 5/16" x 30" NATURAL WOOD | 5.70 | 5.20 | .08 |

POW-MIA AUTO WINDOW FLAG

Comes complete with 11" x 13" polyester flag.

Supplied with 1-piece plastic bracket.

| ITEM # | 1-11 | 12+ | LBS. |
|--------|---------|---------|------|
| 070384 | \$25.10 | \$22.70 | .28 |





Honor and Remember flags show support for all the American lives lost in the defense of Freedom.

OUTDOOR HONOR & REMEMBER FLAG

- **The Red Field** represents the blood spilled by brave men and women in America's military throughout our history, who willingly gave their lives so that we all would remain free.
- **The Blue Star** represents active service in military conflict. This symbol originated with World War I, but on this flag it signifies service through all generations from the American Revolution to present day.
- **The White Border** beneath and surrounding the gold star recognizes the purity of sacrifice. There is no greater price an American can pay than to give his or her life in service to our country.

- **The Gold Star** signifies the ultimate sacrifice of a warrior in active service who will not return home. Gold reflects the value of the life that was given.
- **The Folded Flag** signifies the final tribute to an individual life that a family sacrificed and gave to the nation.
- **The Flame** is an eternal reminder of the spirit that has departed this life yet burns on in the memory of all who knew and loved the fallen hero.

| ITEM # | SIZE | PRICE | LBS. |
|--------|---------|---------|------|
| 070475 | 3' x 5' | \$71.00 | .45 |

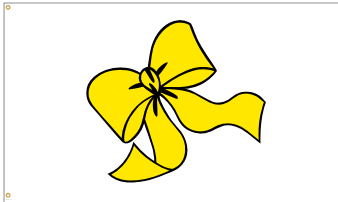

YELLOW RIBBON FLAG

Nylon With Canvas Header & Brass Grommets

Yellow Ribbon Flags are a symbol of support for our military men and women serving our country overseas.

| ITEM # | SIZE | 1-5 | 6+ | LBS. |
|--------|---------|---------|---------|------|
| 070324 | 3' x 5' | \$62.00 | \$55.00 | .45 |



3' x 5' Nylon



4" x 6" E-Gloss

MERCHANT MARINE FLAGS

| ITEM # | SIZE | STYLE | 1-5 | 6+ | LBS. |
|--------|-----------|-------------|-----------|----------|------|
| 070385 | 12" x 18" | NYLON O/D | \$20.70 | \$18.60 | .10 |
| 070386 | 2' x 3' | NYLON O/D | 52.90 | 51.40 | .25 |
| 070387 | 3' x 5' | NYLON O/D | 78.50 | 73.00 | .45 |
| 070388 | 4' x 6' | NYLON O/D | 112.00 | 101.50 | .70 |
| 070389 | 5' x 8' | NYLON O/D | 145.00 | 143.00 | 1.0 |
| 070192 | 3' x 5' | E-POLY O/D | 24.00 | 22.00 | .32 |
| ITEM # | SIZE | STYLE | 1-11 DOZ* | 12+ DOZ* | LBS. |
| 070380 | 4" x 6" | E-GLOSS MTD | \$30.00 | \$27.40 | .36 |
| ITEM # | SIZE | STYLE | 1-143 | 144+ | LBS. |
| 070381 | 12" x 18" | E-POLY MTD | \$5.70 | \$5.20 | .08 |

*SOLD BY THE DOZEN

- Outdoor flags supplied with canvas header & brass grommets.
- 4" x 6" mounted on 3/16" x 10" black plastic staff with gold spear.
- 12" x 18" mounted on 5/16" x 30" natural wood staff with gold spear.



WORLD WAR II



KOREAN WAR



VIETNAM

OUTDOOR VETERANS COMMEMORATIVE FLAGS

Nylon With Canvas Header & Brass Grommets

| ITEM # | SIZE | DESCRIPTION | 1-5 | 6+ | LBS. |
|--------|---------|--------------|----------|----------|------|
| 070238 | 3' x 4' | WORLD WAR II | \$119.50 | \$117.00 | .43 |
| 070239 | 3' x 5' | KOREAN WAR | 119.50 | 117.00 | .45 |
| 070240 | 3' x 5' | VIETNAM | 119.50 | 117.00 | .45 |

3' X 5' MISCELLANEOUS MILITARY FLAGS

Endura-Poly™ w/ White Header & Brass Grommets

| 1-11 | 12+ | LBS. |
|---------|---------|------|
| \$30.00 | \$26.50 | .27 |



AIRBORNE
070253



BLUE ANGELS
070254



CAMO AIRBORNE
070255



82nd AIRBORNE
070256



1st CAVALRY DIVISION
070257



101st AIRBORNE
070258



SEABEES
070259



THUNDER-BIRDS
070260



U.S. NAVY SEALS
070261



VIETNAM INSIGNIA
070262



EMS

| ITEM # | SIZE | STYLE | 1-5 | 6+ | LBS. |
|--------|---------|-----------|---------|---------|------|
| 070287 | 3' x 5' | NYLON O/D | \$62.00 | \$55.00 | .45 |



FIRE DEPARTMENT

| ITEM # | SIZE | STYLE | 1-5 | 6+ | LBS. |
|--------|---------|-----------|---------|---------|------|
| 070283 | 3' x 5' | NYLON O/D | \$62.00 | \$55.00 | .45 |



FIRE RESCUE

| ITEM # | SIZE | STYLE | 1-5 | 6+ | LBS. |
|--------|---------|-----------|---------|---------|------|
| 070286 | 3' x 5' | NYLON O/D | \$62.00 | \$55.00 | .45 |



FIREFIGHTERS

| ITEM # | SIZE | STYLE | 1-5 | 6+ | LBS. |
|--------|---------|-----------|---------|---------|------|
| 070284 | 3' x 5' | NYLON O/D | \$62.00 | \$55.00 | .45 |



FIREMAN MOURNING

| ITEM # | SIZE | STYLE | 1-5 | 6+ | LBS. |
|--------|---------|-----------|---------|---------|------|
| 070312 | 3' x 5' | NYLON O/D | \$62.00 | \$55.00 | .45 |



FIREMAN REMEMBRANCE

| ITEM # | SIZE | STYLE | 1-5 | 6+ | LBS. |
|--------|---------|-----------|---------|---------|------|
| 070322 | 3' x 5' | NYLON O/D | \$63.00 | \$57.00 | .45 |



THIN RED LINE

| ITEM # | SIZE | STYLE | 1-5 | 6+ | LBS. |
|--------|---------|-----------|---------|---------|------|
| 070479 | 2' x 3' | NYLON O/D | \$25.80 | \$24.60 | .25 |
| 070477 | 3' x 5' | NYLON O/D | 32.50 | 31.00 | .45 |



FIREFMEN

| ITEM # | SIZE | OUTDOOR | 1-5 | 6+ | LBS. |
|--------|---------|---------|---------|---------|------|
| 070285 | 3' x 5' | NYLON | \$62.00 | \$55.00 | .45 |



POLICE MOURNING

| ITEM # | SIZE | STYLE | 1-5 | 6+ | LBS. |
|--------|---------|-----------|---------|---------|------|
| 070313 | 3' x 5' | NYLON O/D | \$62.00 | \$55.00 | .45 |



POLICE REMEMBRANCE

| ITEM # | SIZE | STYLE | 1-5 | 6+ | LBS. |
|--------|---------|-----------|---------|---------|------|
| 070323 | 3' x 5' | NYLON O/D | \$63.00 | \$57.00 | .45 |



THIN BLUE LINE

| ITEM # | SIZE | STYLE | 1-5 | 6+ | LBS. |
|--------|---------|-----------|---------|---------|------|
| 070478 | 2' x 3' | NYLON O/D | \$25.80 | \$24.60 | .25 |
| 070474 | 3' x 5' | NYLON O/D | 32.50 | 31.00 | .45 |



NYLON THIN BLUE LINE FAN

| ITEM # | SIZE | STYLE | 1-11 | 12-23 | 24+ | LBS. |
|--------|---------|-----------|---------|---------|---------|------|
| 070480 | 3' x 6' | NYLON O/D | \$68.30 | \$61.70 | \$58.80 | .90 |



STAR OF LIFE

| ITEM # | SIZE | STYLE | 1-5 | 6+ | LBS. |
|--------|---------|-----------|---------|---------|------|
| 070288 | 3' x 5' | NYLON O/D | \$62.00 | \$55.00 | .45 |

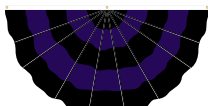

NYLON MOURNING FAN

| ITEM # | SIZE | STYLE | PRICE | LBS. |
|--------|---------|-----------|---------|------|
| 070318 | 3' x 6' | NYLON O/D | \$58.00 | .90 |

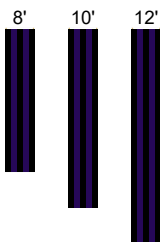

NYLON MOURNING PULLDOWNS

| ITEM # | SIZE | PRICE | LBS. |
|--------|-----------|---------|------|
| 070319 | 8' x 20" | \$33.50 | .50 |
| 070320 | 10' x 20" | 37.50 | .60 |
| 070321 | 12' x 20" | 40.50 | .65 |



BLACK NYLON MOURNING STREAMERS

| ITEM # | SIZE | STYLE | PRICE | LBS. |
|--------|---------|--------|---------|------|
| 070481 | 2" x 5' | SINGLE | \$16.30 | .02 |
| 070482 | 2" x 5' | DOUBLE | 19.90 | .03 |

THERMOPLASTIC MEMORIAL MARKERS

Permanently antiqued and highlighted in bronze with a clear protective over coating. Supplied complete with a 3/8" x 18" silver aluminum rod for easy ground planting. Rear flag holder will accept up to a 3/8" diameter staff.



U.S. VETERAN
Shown with Planting Rod



U.S. VETERAN



U.S. WAR VETERAN



REVOLUTIONARY MINUTEMAN



GRAND ARMY OF THE REPUBLIC



CONFEDERATE VETERAN



WORLD WAR I



WORLD WAR II



KOREAN YALU RIVER



KOREAN EAGLE



VIETNAM BAMBOO



VIETNAM STAR

| ITEM # | DESCRIPTION | 1-5 | 6+ | LBS. |
|--------|----------------------------|---------|---------|------|
| 070362 | U.S. VETERAN | \$26.40 | \$23.90 | .40 |
| 070352 | U.S. WAR VETERAN | 26.40 | 23.90 | .45 |
| 070353 | REVOLUTIONARY MINUTEMAN | 26.40 | 23.90 | .45 |
| 070354 | GRAND ARMY OF THE REPUBLIC | 26.40 | 23.90 | .45 |
| 070355 | CONFEDERATE VETERAN | 26.40 | 23.90 | .45 |
| 070356 | WORLD WAR I | 26.40 | 23.90 | .45 |
| 070357 | WORLD WAR II | 26.40 | 23.90 | .45 |
| 070358 | KOREAN YALU RIVER | 26.40 | 23.90 | .45 |
| 070359 | KOREAN EAGLE | 26.40 | 23.90 | .45 |
| 070360 | VIETNAM BAMBOO | 26.40 | 23.90 | .45 |
| 070361 | VIETNAM STAR | 26.40 | 23.90 | .45 |

MEMORIAL CASES

CHERRY

Beveled Glass Front



Back Closure

070331 shown

| ITEM # | STYLE | REC. FLAG SIZE | 1-5 | 6+ | LBS. |
|--------|-----------------|----------------|----------|----------|------|
| 070331 | w/ETCHED SEAL | 5' x 9-1/2' | \$509.00 | \$485.00 | 7.9 |
| 070332 | w/o ETCHED SEAL | 5' x 9-1/2' | 491.00 | 468.00 | 7.9 |

OAK

Glass Front



Back Closure

070334 shown

| MODEL | ITEM # | REC. FLAG SIZE | 1-5 | 6+ | LBS. |
|-------|--------|----------------|----------|----------|------|
| IFC-2 | 070333 | 3' x 5' | \$246.50 | \$236.00 | 3.3 |
| IFC-1 | 070334 | 5' x 9-1/2' | 315.00 | 299.50 | 5.8 |

METALLIC GRAY

Glass Front



Back Closure

| MODEL | ITEM # | REC. FLAG SIZE | 1-5 | 6+ | LBS. |
|-------|--------|----------------|----------|----------|------|
| IFC-G | 070476 | 5' x 9-1/2' | \$315.00 | \$299.50 | 5.8 |

POPLAR

Cherry Finish
Glass Front



Back Closure

| MODEL | ITEM # | REC. FLAG SIZE | 1-5 | 6+ | LBS. |
|-------|--------|----------------|----------|----------|------|
| IFC-P | 070335 | 5' x 9-1/2' | \$156.50 | \$150.00 | 5.3 |

MAPLE

Plexiglass Front



Back Closure

| MODEL | ITEM # | REC. FLAG SIZE | 1-5 | 6+ | LBS. |
|-------|--------|----------------|----------|----------|------|
| IFC-M | 070336 | 5' x 9-1/2' | \$156.50 | \$150.00 | 5.2 |

PLASTIC

With Zipper



Zipper Closure

| MODEL | ITEM # | REC. FLAG SIZE | 1-5 | 6+ | LBS. |
|-------|--------|----------------|---------|---------|------|
| MFC-1 | 070339 | 5' x 9-1/2' | \$31.90 | \$28.20 | .17 |

Flags pictured in the Memorial Cases not included in the above pricing. See [pages 2 through 7](#) for U.S. Flags.

INTERNATIONAL CODE OF SIGNALS

Nylon, sewn throughout with double-stitched seams in approved colors. Set is supplied with durable storage/carrying bag.

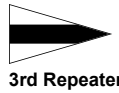
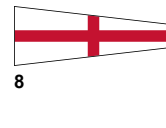
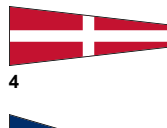
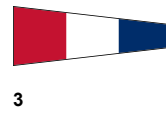
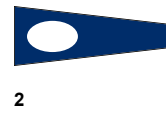
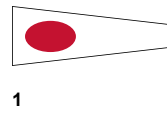
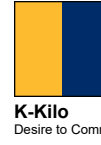

BRASS GROMMETS

| SIZE | DESCRIPTION |
|------|--|
| 3 | 26 Alphabet Flags: 2' x 2' 11 Pennants: 1-1/3' x 3' 3 Substitutes: 1-1/3' x 2-1/3' |

| ITEM # | SETS | | | INDIVIDUAL FLAGS | | |
|--------|------|------------|------|------------------|---------|------|
| | SIZE | PRICE | LBS. | SIZE | PRICE | LBS. |
| 080843 | 3 | \$1,205.00 | 11 | 3 | \$50.00 | .24 |

NYLON STORM WARNING SIGNAL FLAGS & PENNANTS

With Canvas Header & Brass Grommets

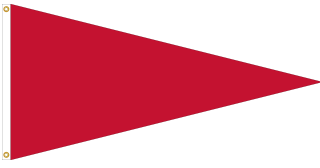

Gale Pennant

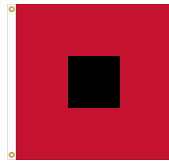

Hurricane Flag

| INDIVIDUAL FLAGS | ITEM # | SIZE | DESCRIPTION | PRICE | LBS. |
|------------------|-----------|----------------|----------------|---------|------|
| | 080847 | 18" x 36" | GALE PENNANT | \$15.50 | .18 |
| | 080848 | 36" x 72" | GALE PENNANT | 23.50 | .35 |
| | 080846 | 18" x 18" | HURRICANE FLAG | 16.10 | .20 |
| 080845 | 36" x 36" | HURRICANE FLAG | 25.50 | .40 | |

| COMPLETE SETS | ITEM # | SET # | DESCRIPTION | PRICE | LBS. |
|---------------|--------|---|---|---------|------|
| | 080666 | 1 | (2) 18" x 18" Hurricane Flags and (2) 18" x 36" Gale Pennants | \$56.00 | .80 |
| 080667 | 2 | (2) 36" x 36" Hurricane Flags and (2) 36" x 72" Gale Pennants | 88.50 | 1.3 | |

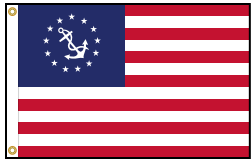

NYLON U.S. YACHT ENSIGNS

With Canvas Header & Brass Grommets

| ITEM # | SIZE | DESCRIPTION | PRICE | LBS. |
|--------|-----------|------------------------------|---------|------|
| 080001 | 12" x 18" | EMBROID. FIELD, SEWN STRIPES | \$34.80 | .10 |
| 080003 | 20" x 30" | EMBROID. FIELD, SEWN STRIPES | 48.50 | .25 |
| 080005 | 30" x 48" | APPLIQUÉ FIELD, SEWN STRIPES | 101.00 | .40 |
| 080006 | 3' x 5' | APPLIQUÉ FIELD, SEWN STRIPES | 106.50 | .60 |
| 080007 | 4' x 6' | APPLIQUÉ FIELD, SEWN STRIPES | 137.00 | .80 |



NYLON RACE COMMITTEE FLAGS

With Canvas Header & Brass Grommets

| ITEM # | SIZE | PRICE | LBS. |
|--------|-----------|---------|------|
| 080054 | 12" x 18" | \$29.40 | .10 |
| 080055 | 20" x 30" | 56.00 | .25 |
| 080056 | 24" x 36" | 61.00 | .30 |
| 080057 | 30" x 48" | 64.50 | .45 |
| 080058 | 3' x 5' | 90.00 | .60 |
| 080059 | 4' x 6' | 120.00 | .90 |

12" X 18" NYLON FLAG OFFICERS FLAGS

With Canvas Header & Brass Grommets



COMMODORE



VICE-COMMODORE



REAR COMMODORE



PAST COMMODORE

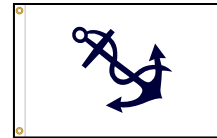

FLEET CAPTAIN



PORT CAPTAIN



TREASURER



SECRETARY



QUARTERMASTER



MEASURER



SURGEON

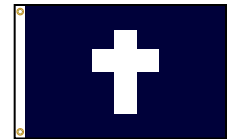

CHAPLAIN

| ITEM # | DESCRIPTION | CONSTRUCTION | 1-5 | 6+ | LBS. |
|--------|----------------|--------------|---------|---------|------|
| 080032 | COMMODORE | FULLY DYED | \$32.30 | \$30.80 | .10 |
| 080033 | VICE-COMMODORE | FULLY DYED | 32.30 | 30.80 | .10 |
| 080034 | REAR COMMODORE | FULLY DYED | 32.30 | 30.80 | .10 |
| 080035 | PAST COMMODORE | FULLY DYED | 32.30 | 30.80 | .10 |
| 080036 | FLEET CAPTAIN | FULLY DYED | 32.30 | 30.80 | .10 |
| 080037 | PORT CAPTAIN | FULLY DYED | 32.30 | 30.80 | .10 |
| 080038 | TREASURER | FULLY DYED | 32.30 | 30.80 | .10 |
| 080039 | SECRETARY | FULLY DYED | 32.30 | 30.80 | .10 |
| 080040 | QUARTERMASTER | FULLY DYED | 32.30 | 30.80 | .10 |
| 080041 | MEASURER | FULLY DYED | 32.30 | 30.80 | .10 |
| 080042 | SURGEON | FULLY DYED | 32.30 | 30.80 | .10 |
| 080043 | CHAPLAIN | FULLY DYED | 32.30 | 30.80 | .10 |



BRITISH RED ENSIGN

Nylon with Canvas Header & Grommets

| ITEM # | SIZE | PRICE | LBS. |
|--------|-----------|---------|------|
| 080672 | 12" x 18" | \$21.00 | .10 |



BAHAMAS MERCHANT

Nylon with Canvas Header & Grommets

| ITEM # | SIZE | PRICE | LBS. |
|--------|-----------|---------|------|
| 080669 | 12" x 18" | \$21.00 | .10 |

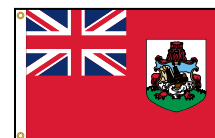

BERMUDA MERCHANT

Nylon with Canvas Header & Grommets

| ITEM # | SIZE | PRICE | LBS. |
|---------------------------------------|------|-------|------|
| See Page 26 (Bermuda) | | | |



3'x5' Nylon

JOLLY ROGER OUTDOOR FLAGS

With Canvas Header & Brass Grommets

| ITEM # | SIZE | MATERIAL | 1-5 | 6+ | LBS. |
|--------|-----------|----------|---------|--------|------|
| 080673 | 12" x 18" | E-POLY | \$10.30 | \$9.50 | .05 |
| 080674 | 12" x 18" | NYLON | 15.50 | 13.90 | .10 |
| 080676 | 2' x 3' | NYLON | 33.20 | 30.20 | .25 |
| 080677 | 3' x 5' | E-POLY | 30.00 | 26.50 | .27 |
| 080678 | 3' x 5' | NYLON | 58.50 | 55.50 | .45 |
| 080679 | 4' x 6' | NYLON | 85.00 | 82.00 | .70 |
| 080680 | 5' x 8' | NYLON | 129.00 | 123.00 | 1.0 |

JOLLY ROGER MOUNTED FLAGS

With Gold Spears

| ITEM # | SIZE | FLAG MATERIAL | STAFF SIZE, COLOR & MATERIAL | 1-143 | 144+ | LBS. |
|--------|-----------|---------------|------------------------------|--------|--------|------|
| 080682 | 12" x 18" | E-POLY | 5/16" x 30" NATURAL WOOD | \$5.70 | \$5.20 | .08 |



JOLLY ROGER OUTDOOR BOW PENNANT

With Canvas Header & Brass Grommets

| ITEM # | SIZE | MATERIAL | 1-11 | 12+ | LBS. |
|--------|-----------|----------|---------|---------|------|
| 080687 | 10" x 15" | NYLON | \$12.50 | \$11.20 | .10 |

12" X 18" NYLON OUTDOOR NOVELTY BOAT FLAGS

With Canvas Header & Brass Grommets

| SIZE | MATERIAL | 1-11 | 12+ | LBS. |
|-----------|----------|---------|---------|------|
| 12" x 18" | NYLON | \$13.70 | \$12.10 | .07 |



BEER MUG
080695



COCKTAIL TIME
080696



19th HOLE
080703



SKUNK
080705



WIFE ON BOARD
080712



SKIN DIVER

Nylon flags with canvas header & brass grommets.

| ITEM # | SIZE | PRICE | LBS. |
|--------|-----------|---------|------|
| 080644 | 10" x 15" | \$16.10 | .07 |
| 080645 | 12" x 18" | 17.70 | .10 |
| 080646 | 16" x 24" | 26.70 | .15 |
| 080647 | 20" x 30" | 27.90 | .20 |
| 080648 | 24" x 36" | 40.50 | .25 |



QUARANTINE

Nylon flags with canvas header & brass grommets.

| ITEM # | SIZE | PRICE | LBS. |
|--------|-----------|--------|------|
| 080649 | 10" x 15" | \$9.40 | .07 |
| 150059 | 12" x 18" | 10.70 | .10 |
| 080650 | 16" x 24" | 13.20 | .15 |
| 080651 | 20" x 30" | 15.50 | .20 |
| 150137 | 24" x 36" | 18.00 | .25 |



ABSENT

Nylon flags with canvas header & brass grommets.

| ITEM # | SIZE | PRICE | LBS. |
|--------|-----------|--------|------|
| 080652 | 10" x 15" | \$9.40 | .07 |
| 150030 | 12" x 18" | 10.70 | .10 |
| 080653 | 16" x 24" | 13.20 | .15 |
| 080654 | 20" x 30" | 15.50 | .20 |
| 150108 | 24" x 36" | 18.00 | .25 |



GUEST

Nylon flags with canvas header & brass grommets.

| ITEM # | SIZE | PRICE | LBS. |
|--------|-----------|---------|------|
| 080661 | 10" x 15" | \$16.10 | .07 |
| 080662 | 12" x 18" | 17.70 | .10 |
| 080663 | 16" x 24" | 26.70 | .15 |
| 080664 | 20" x 30" | 27.90 | .20 |
| 080665 | 24" x 36" | 40.50 | .25 |



PROTEST

Nylon flags with canvas header & brass grommets.

| ITEM # | SIZE | PRICE | LBS. |
|--------|-----------|--------|------|
| 080658 | 10" x 15" | \$9.40 | .07 |
| 150069 | 12" x 18" | 10.70 | .10 |
| 080659 | 16" x 24" | 13.20 | .15 |
| 080660 | 20" x 30" | 15.50 | .20 |
| 150147 | 24" x 36" | 18.00 | .25 |



DINNER

Nylon flags with canvas header & brass grommets.

| ITEM # | SIZE | PRICE | LBS. |
|--------|-----------|--------|------|
| 080655 | 10" x 15" | \$9.40 | .07 |
| 150001 | 12" x 18" | 10.70 | .10 |
| 080656 | 16" x 24" | 13.20 | .15 |
| 080657 | 20" x 30" | 15.50 | .20 |
| 150079 | 24" x 36" | 18.00 | .25 |

**3' X 5' NYLON OUTDOOR
SPECIAL OCCASION FLAGS**

With Canvas Header & Brass Grommets

| 1-5 | 6+ | LBS. |
|---------|---------|------|
| \$42.00 | \$39.00 | .45 |

*Limited quantities available



090001 – "HAPPY VALENTINE'S"



*090002 – "VALENTINE'S DAY"



090023 – "SPRING FLOWERS"



*090027 – "SPRING"



090005 – "EASTER EGGS"



*090006 – "HAPPY EASTER"

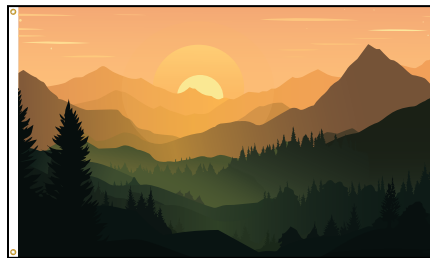

090018 – "SUMMER MOUNTAINS"



*090028 – "SUMMER"



090015 – "FALL HARVEST"



*090029 – "FALL"



090011 – "PUMPKIN"



090012 – "WITCH"



090024 – "WINTER TIME"



*090026 – "WINTER"



090016 – "MERRY CHRISTMAS"



090017 – "HAPPY HOLIDAYS"



090068 – "MADE IN USA"

PINK RIBBON FLAGS

- Nylon flags finished with Canvas Header & Brass Grommets.
- Printed single reverse flag reads "Hope, Love, Strength, Courage".
- Sewn fully appliquéed flag constructed in double patch style and reads "Hope" and "Love".
- Stick flags mounted on 3/16" x 10" black plastic staff w/gold spear.



| ITEM # | SIZE | OUTDOOR | PRICE | LBS. |
|--------|---------|---------------|----------------|------|
| 090060 | 2' x 3' | NYLON PRINTED | \$29.50 | .25 |
| 090061 | 3' x 5' | NYLON PRINTED | 48.00 | .45 |



10% of each sale will be contributed to help the American Cancer Society®* save more lives by helping people stay well and get well, by finding cures, and by fighting back against cancer.

*The American Cancer Society® does not endorse any product or service.

RAINBOW FLAGS & PLEATED FANS

- Nylon flags finished with Canvas Header & Brass Grommets.
- Nylon fan finished with Canvas Header & Brass Grommets.

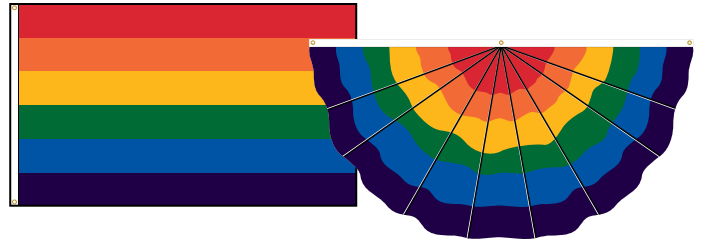

| ITEM # | SIZE | OUTDOOR | 1-5 | 6+ | LBS. |
|--------|-----------|-------------|----------------|----------------|------|
| 090043 | 16" x 24" | NYLON | \$20.60 | \$17.60 | .15 |
| 090044 | 2' x 3' | NYLON | 30.50 | 28.00 | .30 |
| 090045 | 3' x 5' | NYLON | 41.00 | 37.50 | .55 |
| 090046 | 4' x 6' | NYLON | 54.00 | 51.50 | .80 |
| 090047 | 5' x 8' | NYLON | 106.00 | 103.00 | 1.2 |
| 090048 | 6' x 10' | NYLON | 139.00 | 132.00 | 1.7 |
| ITEM # | SIZE | OUTDOOR FAN | 1-2 | 6+ | LBS. |
| 090049 | 3' x 6' | NYLON | \$71.50 | \$65.50 | .95 |

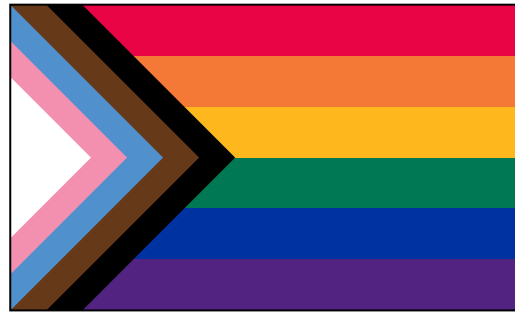

PROGRESS PRIDE

| ITEM # | SIZE | OUTDOOR | 1-5 | 6+ | LBS. |
|--------|---------|---------|----------------|----------------|------|
| 090066 | 3' x 5' | NYLON | \$72.50 | \$65.50 | .45 |
| 090067 | 4' x 6' | NYLON | 103.00 | 92.50 | .80 |

5' DISPLAY POLES

Poles come with Wood Ball & Nev-R-Wrap™ Rotating Tube



| ITEM # | DESCRIPTION | 1-5 | 6+ |
|--------|------------------|---------|---------|
| 100056 | NATURAL WOOD | \$19.30 | \$18.00 |
| 100058 | WHITE FIBERGLASS | 29.50 | 28.00 |

Wood weight: 1.5 lbs. • Fiberglass weight: 1.7 lbs.

POLE RINGS

Sold in complete sets only as shown



| ITEM # | FOR POLE DIA. | COLOR | 1-5 | 6+ |
|--------|---------------|-------|--------|--------|
| 100059 | 15/16" | BEIGE | \$2.96 | \$2.72 |
| 100060 | 15/16" | WHITE | 2.96 | 2.72 |
| 100061 | 1" | WHITE | 2.96 | 2.72 |

15/16" weight: .03 lbs. • 1" weight: .02 lbs.

37" ROTATING TUBES

- Outside Diameter: 1-1/4"
- Inside Diameter: 1-3/16"



| ITEM # | COLOR | 1-5 | 6+ | LBS. |
|--------|-------|--------|--------|------|
| 100062 | BEIGE | \$2.96 | \$2.72 | .16 |
| 100063 | WHITE | 2.96 | 2.72 | .16 |



9' X 1" ROTATING POLE WITH LAWN SOCKET

This white painted aluminum 2-piece pole is your ultimate choice for a display pole. The top rotates on ball bearings so the flag will never tangle. For the easiest and most versatile installation, this pole comes with two flag fasteners for flying a grommeted flag and also with a snap and swivel ring for displaying flags with a pole sleeve and tab. The pole comes complete with a galvanized steel lawn socket.

| ITEM # | 1-11 | 12-35 | 36+ | LBS. |
|--------|---------|---------|---------|------|
| 324178 | \$69.80 | \$61.20 | \$58.10 | 3.3 |

3' X 5' NYLON HORIZONTAL MESSAGE FLAGS

With Canvas Header & Brass Grommets

| 1-11 | 12-23 | 24+ | LBS. |
|---------|---------|---------|------|
| \$35.50 | \$34.50 | \$32.50 | .45 |



120000



120012



120040



120045



120046



120047



120048



120053

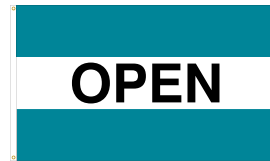

120054



120055



120063



120086



3' X 5' BLANK MESSAGE FLAG

| ITEM # | DESCRIPTION | 1-11 | 12-23 | 24+ | LBS. |
|--------|------------------|---------|---------|---------|------|
| 120091 | RED WHITE & BLUE | \$30.50 | \$29.50 | \$28.00 | .45 |



5' x 3' Nylon Vertical Message Flags can be mixed to achieve the higher quantity pricing.

120112

5' X 3' NYLON VERTICAL MESSAGE FLAGS

With Canvas Header & Brass Grommets

| 1-11 | 12-23 | 24+ | LBS. |
|---------|---------|---------|------|
| \$35.50 | \$34.50 | \$32.50 | .45 |

See [page 73](#) for pricing of blank message flags.

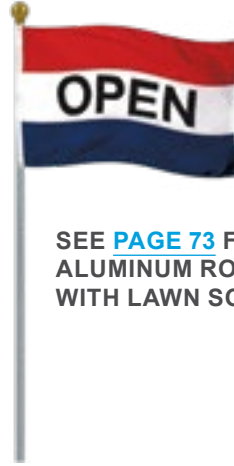

SEE [PAGE 73](#) FOR OUR 9' X 1" ALUMINUM ROTATING POLE WITH LAWN SOCKET



WE SPEAK SPANISH
120105

WE FINANCE
120103

3' X 5' SPANISH NYLON MESSAGE FLAGS

With Canvas Header & Brass Grommets

| 1-11 | 12-23 | 24+ | LBS. |
|---------|---------|---------|------|
| \$35.50 | \$34.50 | \$32.50 | .45 |



NYLON BLACK & WHITE OPEN CHECKERED FLAG

With Canvas Header & Brass Grommets

| ITEM # | SIZE | 1-5 | 6+ | LBS. |
|--------|---------|---------|---------|------|
| 120202 | 3' x 5' | \$55.50 | \$54.00 | .45 |

SEE [PAGES 79-81](#) FOR CUSTOM FLAGS AND BANNERS

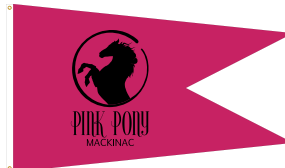
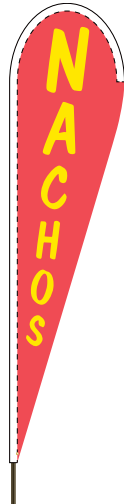

24" X 30" OFFICIAL SIZE NYLON AUTO RACING FLAGS

Mounted Flags Come on 15/16" x 52" Wood Pole • Pole Sleeve and Grommeted Flags are Unmounted

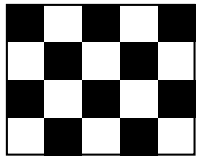

END OF RACE (SEWN)

| ITEM # | STYLE | 1-5 | 6+ | LBS. |
|--------|-------------|---------|---------|------|
| 110006 | MOUNTED | \$70.00 | \$64.50 | 1.1 |
| 110014 | POLE SLEEVE | 67.50 | 61.50 | .30 |
| 110022 | GROMMETED | 69.00 | 62.50 | .35 |

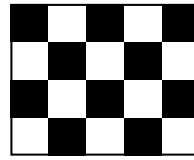

END OF RACE (PRINTED)

| ITEM # | STYLE | 1-5 | 6+ | LBS. |
|--------|-------------|---------|---------|------|
| 110007 | MOUNTED | \$39.00 | \$37.50 | 1.0 |
| 110015 | POLE SLEEVE | 31.50 | 29.50 | .20 |
| 110023 | GROMMETED | 35.00 | 34.00 | .25 |



E-Gloss

Plastic

4" X 5" PLASTIC AUTO RACING FLAGS COMPLETE SETS

With Black Plastic Table Base

| ITEM # | DESCRIPTION | 1-5 | 6+ | LBS. |
|--------|-------------|---------|---------|------|
| 110054 | PLASTIC | \$11.40 | \$10.00 | .15 |

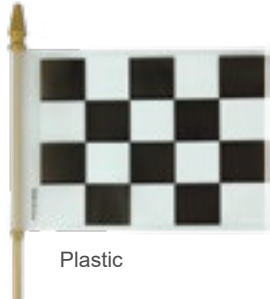

Plastic

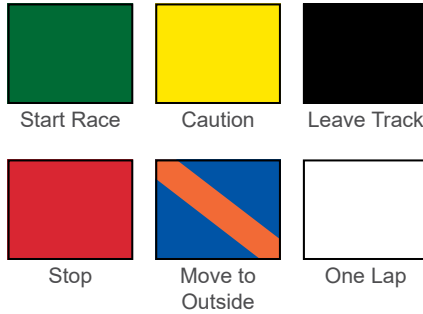

Start Race

Caution

Leave Track

Stop

Move to Outside

One Lap



Endura-Gloss

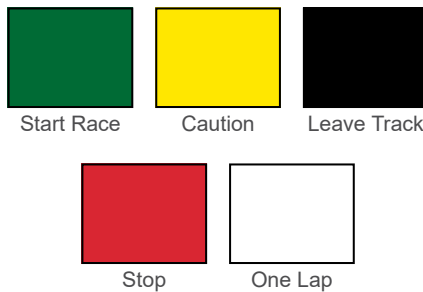

Start Race

Caution

Leave Track

Stop

One Lap

4" X 5" PLASTIC (INDIVIDUAL FLAGS)

Mounted on 3/16" x 10" Gold Plastic Staff w/Gold Spear

| ITEM # | DESCRIPTION | 1-143 | 144+ | LBS. |
|--------|-------------------|--------|--------|------|
| 110027 | START RACE | \$0.58 | \$0.50 | .02 |
| 110028 | CAUTION | 0.58 | 0.50 | .02 |
| 110029 | LEAVE TRACK | 0.58 | 0.50 | .02 |
| 110030 | STOP | 0.58 | 0.50 | .02 |
| 110031 | MOVE TO OUTSIDE | 0.58 | 0.50 | .02 |
| 110032 | ONE LAP TO FINISH | 0.58 | 0.50 | .02 |
| 110033 | END OF RACE | 0.58 | 0.50 | .02 |

4" X 5" ENDURA-GLOSS™ (INDIVIDUAL FLAGS)

Mounted on 3/16" x 10" Black Plastic Staff w/Gold Spear

| ITEM # | DESCRIPTION | 1-11 DOZ* | 12+ DOZ* | LBS. |
|--------|-------------------|-----------|----------|------|
| 110034 | START RACE | \$31.20 | \$28.08 | .36 |
| 110035 | CAUTION | 31.20 | 28.08 | .36 |
| 110036 | LEAVE TRACK | 31.20 | 28.08 | .36 |
| 110037 | STOP | 31.20 | 28.08 | .36 |
| 110039 | ONE LAP TO FINISH | 31.20 | 28.08 | .36 |

*SOLD BY THE DOZEN

SPECIALTY FLAGS | Racing & Sports



FULLY PRINTED OUTDOOR BLACK & WHITE CHECKERED FLAGS

With Canvas Header & Brass Grommets



| ITEM # | SIZE | MATERIAL | 1-5 | 6+ | LBS. |
|--------|---------|----------|---------|---------|------|
| 110057 | 2' x 3' | NYLON | \$48.50 | \$42.00 | .25 |
| 110058 | 3' x 5' | NYLON | 77.50 | 69.00 | .45 |
| 110059 | 4' x 6' | NYLON | 94.00 | 85.50 | .70 |
| 110060 | 5' x 8' | NYLON | 137.00 | 124.00 | 1.0 |
| 110056 | 3' x 5' | E-POLY | 30.00 | 26.50 | .27 |

14" X 20" BLANK NYLON GOLF FLAGS

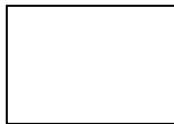
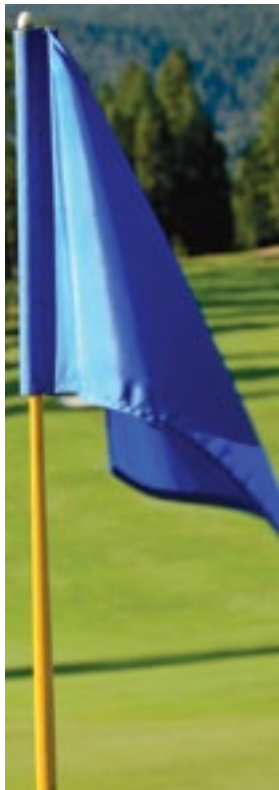

White



Royal Blue



Canada Red



Fm Yellow



Orange



GROMMET STYLE

Canvas Header, 3 Brass Grommets & 3 Cloth Tie Tapes



TUBE STYLE

Mounted on Thermo-Plastic Rotating Tube

| COLOR | GROMMET STYLE | | | | | | TUBE STYLE | | | | | |
|------------|---------------|---------|--------|--------|--------|------|------------|---------|---------|---------|---------|------|
| | ITEM # | 1-9 | 10-18 | 19-27 | 28+ | LBS. | ITEM # | 1-9 | 10-18 | 19-27 | 28+ | LBS. |
| WHITE | 110133 | \$10.70 | \$9.90 | \$9.80 | \$9.70 | .08 | 110303 | \$20.50 | \$19.90 | \$19.80 | \$18.50 | .19 |
| ROYAL BLUE | 110135 | 10.70 | 9.90 | 9.80 | 9.70 | .08 | 110305 | 20.50 | 19.90 | 19.80 | 18.50 | .19 |
| CANADA RED | 110137 | 10.70 | 9.90 | 9.80 | 9.70 | .08 | 110307 | 20.50 | 19.90 | 19.80 | 18.50 | .19 |
| FM YELLOW | 110134 | 10.70 | 9.90 | 9.80 | 9.70 | .08 | 110304 | 20.50 | 19.90 | 19.80 | 18.50 | .19 |
| ORANGE | 110136 | 10.70 | 9.90 | 9.80 | 9.70 | .08 | 110306 | 20.50 | 19.90 | 19.80 | 18.50 | .19 |

Other colors and custom designed golf flags available upon request. Call for pricing.

GOLF FLAG ROTATING TUBES ONLY



| ITEM # | 1-18 | 19-36 | 37-108 | 109+ | LBS. |
|--------|---------|--------|--------|--------|------|
| 110308 | \$10.70 | \$9.90 | \$9.40 | \$8.40 | .95 |



NYLON SOLID COLOR FLAGS

Canvas Header & Brass Grommets

| SIZE | 1-11 | 12-23 | 24+ | LBS. |
|-----------|---------|---------|--------|------|
| 12" x 18" | \$10.70 | \$10.00 | \$9.70 | .08 |
| 2' x 3' | 18.00 | 17.70 | 17.00 | .25 |
| 3' x 5' | 30.30 | 29.30 | 28.40 | .45 |
| 4' x 6' | 46.00 | 45.20 | 44.40 | .70 |
| 5' x 8' | 69.80 | 65.00 | 63.30 | 1.0 |
| 6' x 10' | 103.00 | 96.20 | 93.40 | 1.5 |

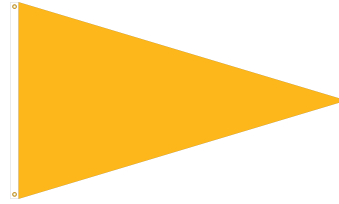

NYLON SOLID COLOR PENNANTS

Canvas Header & Brass Grommets

| SIZE | 1-11 | 12-23 | 24+ | LBS. |
|-----------|---------|---------|--------|------|
| 12" x 18" | \$10.70 | \$10.00 | \$9.70 | .06 |
| 2' x 3' | 19.10 | 17.60 | 16.90 | .15 |
| 3' x 5' | 26.30 | 24.90 | 23.90 | .30 |
| 4' x 6' | 46.80 | 43.70 | 42.30 | .40 |
| 4' x 9' | 54.80 | 51.00 | 49.80 | .50 |
| 5' x 8' | 64.90 | 60.70 | 59.10 | .60 |



FEATHER FLAG ACCESSORIES

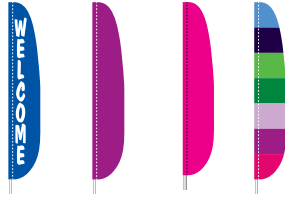

TELESCOPING SUPERFLEX™ POLES

FOR 12' X 26" FEATHER FLAGS

These fiberglass flagpoles sway in the breeze producing a dramatic, attention-getting display. Available in both 15' and 21' exposed height sizes. The 15' pole is adjustable from 6' to 15' while the 21' pole is adjustable from 8' to 21'. Poles come with 21" PVC ground sleeve and easy-to-follow instructions.

| ITEM # | HEIGHT | COLOR | BUTT DIA. | TOP DIA. | 1-11 | 12+ | LBS. |
|--------|--------|-------|-----------|----------|----------|----------|------|
| 323442 | 15' | WHITE | 1-1/4" | 3/4" | \$138.00 | \$119.00 | 5.4 |
| 323443 | 21' | WHITE | 1-1/4" | 3/4" | 146.00 | 126.00 | 7.4 |
| 324172 | 15' | BLACK | 1-1/4" | 3/4" | 138.00 | 119.00 | 5.4 |
| 324173 | 21' | BLACK | 1-1/4" | 3/4" | 146.00 | 126.00 | 7.4 |

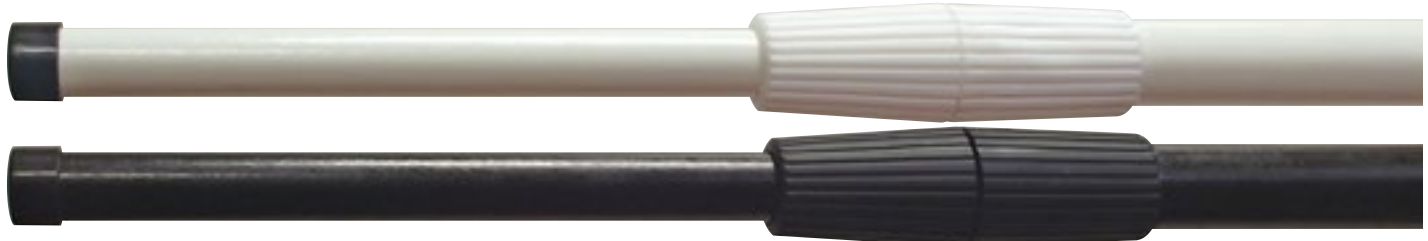

REPLACEMENT GROUND SLEEVES FOR TELESCOPING SUPERFLEX POLES

| ITEM # | LENGTH | PRICE | LBS. |
|--------|--------|---------|------|
| 324187 | 21" | \$11.60 | .30 |



ALUMINUM FEATHER FLAGPOLE FOR 7' X 17" FEATHER FLAGS

This set comes with a two section 1" diameter silver mill finish pole - a 4' bottom and a 5' top plus a galvanized steel fabricated lawn socket. The top of the pole is capped with a plastic top plug to protect the top of the Feather Flag from premature wear.

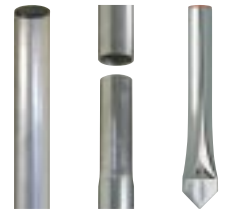

| ITEM # | HEIGHT | COLOR | 1-11 | 12+ | LBS. |
|--------|--------|--------|---------|---------|------|
| 324185 | 9' | SILVER | \$54.00 | \$50.00 | 1.6 |

TEAR DROP FLAG ACCESSORIES

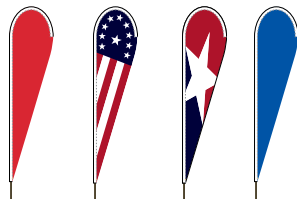

TEAR DROP FLAGPOLE

These continuous tapering, flexible black fiberglass flagpoles measure 14' when fully assembled. The bottom measures 1" and tapers to 1/4" at the top. This 3-piece pole swedges together perfectly and all swedge points are reinforced with stainless steel fittings. Pole is rubber tipped to prevent flag damage. Comes complete with heavy-duty, black canvas carry bag.

| ITEM # | 1-5 | 6-11 | 12+ | LBS. |
|--------|-------|-------|-------|------|
| 155527 | \$123 | \$117 | \$101 | 3.7 |



TEAR DROP POLE IN-GROUND MOUNT

Once installed in the ground, the Tear Drop Flag Pole slips over a rotating spindle. The Tear Drop Pole In-Ground Mount measures a total of 23-3/8" long, with 16" of length under the rotating spindle. Weight = 3.2 Lbs.

| ITEM # | 1-5 | 6-11 | 12+ |
|--------|------|------|------|
| 155528 | \$57 | \$54 | \$49 |

TEAR DROP POLE SURFACE MOUNT

This rotating base can be permanently mounted or can be temporarily held in place with a heavy-duty water donut. When filled, the water donut holds 2-1/4 gallons of water and weighs 18-1/2 pounds. This water donut installation should only be used when winds do not exceed 5 m.p.h.



| ITEM # | 1-5 | 6+ | LBS. |
|--------|------|------|------|
| 155529 | \$99 | \$95 | 8.6 |

CUSTOM PRINTED FLAGS AND BANNERS

Any design and quantity can be printed using our direct print digital/dye sub process. The possibilities are endless with no limit on colors or types of image.

Outdoor flags up to size 6' x10' are finished standard with heavy duty canvas header and two brass grommets. On 8' x 12' and larger flags will be finished with roped header and thimbles.

Other finishing options are available upon request.



MATERIAL OPTIONS

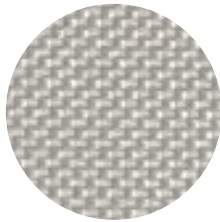

200 DENIER NYLON

Durable with bright colors, suitable for outdoor use. Print can be up to 72" width.

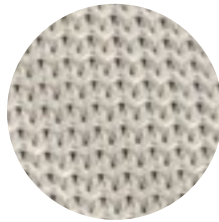

100% TIGHT-KNIT POLYESTER

Excellent flyability and long lasting which is ideal for outdoor use.

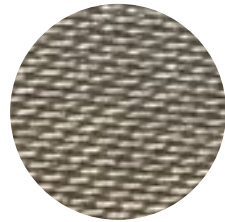

POLY SATIN

Beautiful, silk-like finish suitable for indoor use such as wall and podium banners.

PRINTING OPTIONS

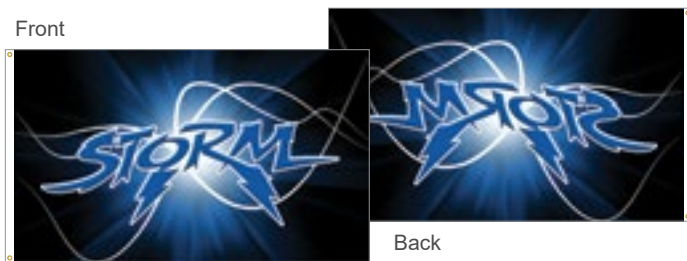

SINGLE REVERSE

Printed on front side with full ink penetration. On the reverse side, the image will appear backwards.



DOUBLE-SIDED

Two flags printed and sewn together back to back with a heavy duty block out liner in between.

ARTWORK REQUIREMENTS

For a prompt approval process please provide the following:

- ✓ For a clean printed image Vector art is required
- ✓ All fonts and strokes are outlined
- ✓ Spell checked for errors and proof the art
- ✓ For maximum color match include solid coated Pantone® colors

• **Note:** undefined process colors may not print as previewed

Preferred and accepted file formats for artwork submission:



.PDF – Portable Document Format



.AI – Adobe Illustrator Document



.EPS – Encapsulated PostScript

All Custom Flags and Banners including our Applied Nylon Outdoor Flags are made in the U.S.A.

CUSTOM AVENUE BANNERS



- VINYL
- POLY TENT
- APPLIQUED NYLON
- SUNBRELLA

We offer full 4-Color process printing on 10-oz. Vinyl, 13-oz. Vinyl and Poly Tent. Since our inks are U.V.-protected, these banners can be used indoors or outdoors with no color fading. Sizes can range up to 52" x 100" or can be tiled to any size. We also offer Appliqued Nylon and Sunbrella Avenue Banners to meet all of your outdoor banner needs.

CUSTOM TENT KIT



This popular tent strikes a perfect balance between cost effectiveness and portability.

- Tent is 10' x 10' when set up
- Canopy available in eight colors
- Crank-up canopy creates a taut, clean peak
- Frame is constructed of 1 mm steel with powder-coated finish
- Frame features ABS nylon joints
- Square-shaped legs are 1.125" x 1.125"
- Legs feature plastic push buttons for pinch-free height adjustment
- Easy-glide tent feet allow the tent frame to slide on dirt and grass, preventing the legs from catching
- Easily collapses to fit inside the included soft case with wheels
- Tent can be secured to the ground with the included stake kit
- Frame must be secured to the ground to prevent wind damage

Kit Includes Hardware (Frame), Full-Color Imprint 400 Denier Polyester Canopy, Carry Case, Ground Stake and Rope

Please contact us for a prompt quotation.

CUSTOM RETRACTOR KIT



This display pictured is as reliable as the popular Economy retractor, but it includes some great additional features like improved durability.

- Heavy-duty aluminum base
- Single-footed design keeps the retractor stable while maintaining a low profile
- Flip-lever telescoping pole makes setup and adjustment simple
- Banner height is adjustable
- Banner attaches with snap rail on top and hook-and-loop fasteners on bottom

Kit Includes Hardware, Single Sided Full-Color Digital 600 Denier Polyester Banner (Installed) and Carry Case

CUSTOM SAIL SIGN KIT



Sail signs are built to move in the wind, making them truly hard to miss. Premium flags are reinforced with black pole pockets constructed of a high tensile elastic polyester binding.

- Due to its feather-like shape, the razor flag style is sometimes called a feather flag
- Flag is reinforced with nylon webbing pole pockets to create a stylish black outline around the edge of the flag
- Flag attaches to a fixed hook on the pole using the included bungee tie kit
- Carbon composite poles are strong and flexible
- Uniform carbon composite overlay pole construction with high-gloss black paint finish
- Polished aluminum collar pole segment ends and ergonomic, rubber-reinforced base grip
- Steel scissor base is great for use on hard, flat surfaces both indoors and out
- Included ballast can be filled with water to keep the unit weighted down
- High tensile strength elastic polyester binding

Kit Includes Single Sided Full-Color Dye Sublimated Super Poly Knit Flag, Hardware, Water Ballast, Base, Carry Case and Bungee Kit

BRACKETS, HOLDERS & ACCESSORIES

DELUXE BANNER ARM MOUNTING SETS

Each set contains cast aluminum mounting bracket(s) with stainless steel mounting straps. Crossbars are fabricated from 1-1/2" outside diameter clear anodized aluminum poles with white end caps for a finished look. Ideal for round poles. For square poles, see U-Bolts on [page 83](#).

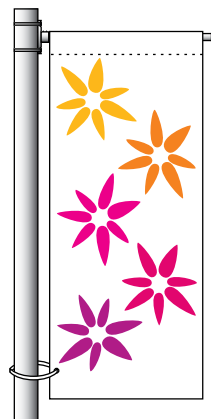
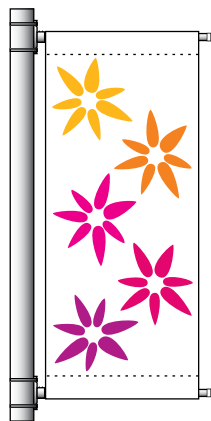
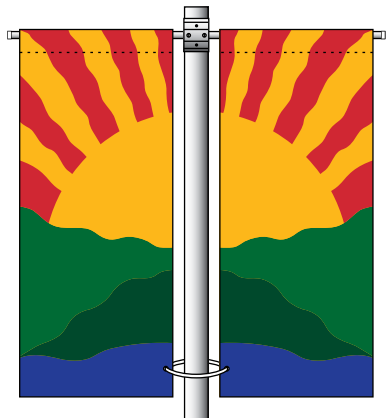
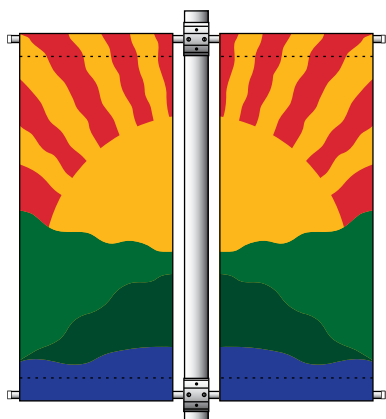

DCA MOUNTING SETS



Each DCA Mounting Set is designed for use with a pair of banners with pole hems at both the top and bottom. Priced Per Set.

| ITEM # | MODEL | REC. BANNER WIDTH | 1-24 | 25-49 | 50+ | LBS. |
|--------|-------|-------------------|----------|----------|----------|------|
| 310012 | DCA18 | 18" | \$211.00 | \$194.00 | \$188.00 | 8.2 |
| 310013 | DCA24 | 24" | 237.00 | 217.00 | 204.00 | 9.4 |
| 310014 | DCA30 | 30" | 242.00 | 225.00 | 211.00 | 11 |
| 310015 | DCA36 | 36" | 268.00 | 247.00 | 232.00 | 12 |

DCA/G MOUNTING SETS



Each DCA/G Mounting Set is designed for use with a pair of banners with pole hems at the top and grommets at the bottom. Priced Per Set.

| ITEM # | MODEL | REC. BANNER WIDTH | 1-24 | 25-49 | 50+ | LBS. |
|--------|---------|-------------------|----------|----------|----------|------|
| 310016 | DCA18/G | 18" | \$130.00 | \$119.00 | \$108.00 | 4.2 |
| 310017 | DCA24/G | 24" | 133.00 | 125.00 | 110.00 | 4.8 |
| 310018 | DCA30/G | 30" | 147.00 | 138.00 | 130.00 | 5.4 |
| 310019 | DCA36/G | 36" | 159.00 | 147.00 | 138.00 | 6.0 |

SCA MOUNTING SETS



Each SCA Mounting Set is designed for use with a single banner with pole hems at both the top and bottom. Priced Per Set.

| ITEM # | MODEL | REC. BANNER WIDTH | 1-24 | 25-49 | 50+ | LBS. |
|--------|-------|-------------------|----------|----------|----------|------|
| 310020 | SCA18 | 18" | \$175.00 | \$163.00 | \$148.00 | 5.0 |
| 310021 | SCA24 | 24" | 180.00 | 168.00 | 153.00 | 5.7 |
| 310022 | SCA30 | 30" | 188.00 | 178.00 | 163.00 | 6.3 |
| 310023 | SCA36 | 36" | 194.00 | 183.00 | 172.00 | 6.9 |

SCA/G MOUNTING SETS



Each SCA/G Mounting Set is designed for use with a single banner with a pole hem at the top and a grommet at the bottom. Priced Per Set.

| ITEM # | MODEL | REC. BANNER WIDTH | 1-24 | 25-49 | 50+ | LBS. |
|--------|---------|-------------------|----------|---------|---------|------|
| 310024 | SCA18/G | 18" | \$106.00 | \$99.00 | \$93.00 | 5.0 |
| 310025 | SCA24/G | 24" | 108.00 | 103.00 | 94.00 | 5.7 |
| 310026 | SCA30/G | 30" | 112.00 | 107.00 | 103.00 | 6.3 |
| 310027 | SCA36/G | 36" | 130.00 | 119.00 | 106.00 | 6.9 |

POLES ONLY FOR DELUXE BANNER ARMS

SINGLE BANNER

| ITEM # | REC. BANNER WIDTH | LENGTH | DIA. | WALL | PRICE | LBS. |
|--------|-------------------|--------|--------|------|----------------|------|
| 310033 | (1) 18" | 24" | 1-1/2" | .125 | \$30.50 | 1.3 |
| 310034 | (1) 24" | 30" | 1-1/2" | .125 | 33.00 | 1.6 |
| 310035 | (1) 30" | 36" | 1-1/2" | .125 | 39.50 | 1.9 |
| 310036 | (1) 36" | 42" | 1-1/2" | .125 | 44.50 | 2.2 |

DOUBLE BANNER

| | | | | | | |
|--------|---------|-----|--------|------|----------------|-----|
| 310037 | (2) 18" | 48" | 1-1/2" | .125 | \$50.50 | 2.5 |
| 310038 | (2) 24" | 60" | 1-1/2" | .125 | 66.00 | 3.1 |
| 310039 | (2) 30" | 72" | 1-1/2" | .125 | 85.00 | 3.7 |
| 310040 | (2) 36" | 84" | 1-1/2" | .125 | 91.00 | 4.3 |

ORNAMENT ADAPTER

This aluminum adapter must be installed at the factory & will accept any ornament with a spindle threading of 1/2"-13NC.



| ITEM # | PRICE | LBS. |
|--------|----------------|------|
| 310041 | \$65.00 | .15 |

Priced per adapter.



U-BOLTS FOR SQUARE POLES

Each U-Bolt comes complete with washers, lock washers, nuts & back plate. Two U-Bolts per bracket are required. Priced per U-Bolt.

| ITEM # | POLE SIZE | 1-24 | 25-49 | 50+ | LBS. |
|--------|-----------|----------------|----------------|----------------|------|
| 310030 | 4" SQUARE | \$21.00 | \$17.90 | \$16.90 | .45 |
| 310031 | 5" SQUARE | 41.50 | 36.30 | 34.00 | .55 |
| 310032 | 6" SQUARE | 42.20 | 36.80 | 35.00 | .60 |

PLASTIC END CAPS



| ITEM # | COLOR | 1-24 | 25-49 | 50+ | LBS. |
|--------|-------|---------------|---------------|---------------|------|
| 310042 | WHITE | \$1.30 | \$0.96 | \$0.72 | .15 |
| 310163 | BLACK | 1.30 | 0.96 | 0.72 | .15 |

BRACKETS FOR DELUXE BANNER ARM SETS

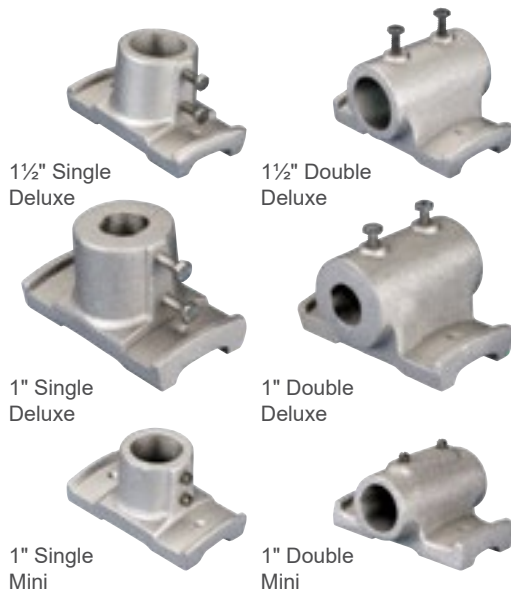

WITH 2 STAINLESS STEEL STRAPS PER BRACKET

| PRICED PER BRACKET | | | | | | |
|--------------------|---------------|---------------|----------------|----------------|----------------|------|
| ITEM # | FOR POLE DIA. | STYLE | 1-24 | 25-49 | 50+ | LBS. |
| 310028 | 1-1/2" | SINGLE DELUXE | \$53.50 | \$49.00 | \$45.50 | 1.0 |
| 310029 | 1-1/2" | DOUBLE DELUXE | 56.00 | 53.50 | 49.00 | 1.3 |
| 310143 | 1" | SINGLE DELUXE | 53.50 | 50.50 | 47.00 | 1.3 |
| 310144 | 1" | DOUBLE DELUXE | 75.00 | 70.00 | 66.00 | 1.6 |
| 310138 | 1" | SINGLE MINI | 39.00 | 37.50 | 33.00 | .33 |
| 310139 | 1" | DOUBLE MINI | 41.50 | 40.00 | 37.50 | .49 |

NO STRAPS

| PRICED PER BRACKET | | | | | | |
|--------------------|---------------|---------------|----------------|----------------|----------------|------|
| ITEM # | FOR POLE DIA. | STYLE | 1-24 | 25-49 | 50+ | LBS. |
| 310145 | 1-1/2" | SINGLE DELUXE | \$39.50 | \$33.00 | \$31.50 | .96 |
| 310146 | 1-1/2" | DOUBLE DELUXE | 42.00 | 39.50 | 36.50 | 1.3 |
| 310149 | 1" | SINGLE DELUXE | 41.00 | 36.50 | 33.00 | .85 |
| 310150 | 1" | DOUBLE DELUXE | 44.50 | 41.00 | 39.50 | 1.2 |
| 310147 | 1" | SINGLE MINI | 31.00 | 28.00 | 25.00 | .25 |
| 310148 | 1" | DOUBLE MINI | 31.50 | 28.50 | 26.50 | .45 |

STREETSCAPE MOUNTING KITS

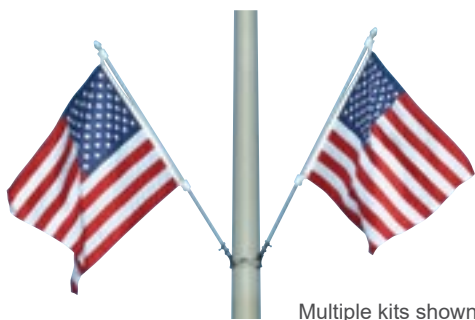

Multiple kits shown

These Streetscape Mounting Kits contain everything you'll need to mount a flag onto an existing street or light pole. Can be used on round poles up to 12" in diameter.

- Included in Kit:
- Silver Stainless Steel Bracket
 - 2 Stainless Steel Mounting Straps
 - 6' Clear Anodized Heavy Wall Aluminum Pole
 - White NeverFurl Kit
 - Silver Plastic Acorn
 - (OPTIONAL) 3' x 5' U.S. Nylon Flag

| ITEM # | FEATURE | 1-49 | 50+ | LBS. |
|--------|---------|-----------------|-----------------|------|
| 310164 | NO FLAG | \$125.00 | \$113.00 | 3.2 |
| 310165 | w/FLAG | 173.00 | 156.00 | 3.7 |



BRACKETS, HOLDERS & ACCESSORIES

ULTIMATE ADJUSTABLE BRACKETS

- Adjusts to 13 different positions including Vertical & Horizontal • For 1" Dia. Poles
- EZ-Grip Thumb Screw • Built-in Windsock Holder for 1/4" Dia. Pole
- Screw Holes for mounting to flat surface (Mounting Screws Included)
- Slots for strap mounting onto a pole (Mounting Straps Sold Separately)



Standard Screw Mount Installation

| ITEM # | MODEL | COLOR / MATERIAL | 1-71 | 72-143 | 144+ | LBS. |
|--------|--------|-------------------------|---------|---------|---------|------|
| 310043 | SU-AJB | SILVER PAINTED ALUMINUM | \$25.20 | \$21.80 | \$19.10 | .85 |



With Stainless Steel Mounting Straps

| ITEM # | MODEL | COLOR / MATERIAL | 1-71 | 72-143 | 144+ | LBS. |
|--------|--------|------------------------|---------|---------|---------|------|
| 310044 | WU-AJB | WHITE PAINTED ALUMINUM | \$25.20 | \$21.80 | \$19.10 | .85 |



Positive Lock Fan Gears

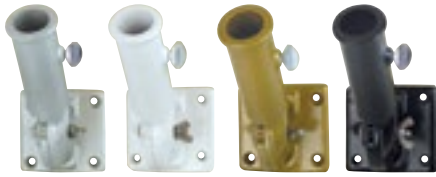

STANDARD ALUMINUM ADJUSTABLE BRACKETS

Supplied with Thumb Screw • Displays Pole at Vertical, 25°, 50°, 65° or Horizontal • For 1" Dia. Poles

| ITEM # | MODEL | COLOR | 1-23 | 24-143 | 144+ | LBS. |
|--------|-------|--------|---------|---------|---------|------|
| 310046 | AJB | SILVER | \$26.80 | \$24.00 | \$23.50 | .85 |
| 310047 | AJB-W | WHITE | 31.60 | 28.90 | 27.50 | .85 |
| 310048 | AJB-G | GOLD | 34.50 | 31.60 | 30.80 | .85 |
| 310049 | AJB-B | BLACK | 32.70 | 28.80 | 28.20 | .85 |

ADAPTER FOR STANDARD ALUMINUM ADJUSTABLE BRACKETS

Fits into the shaft of the AJB to accommodate a 3/4" Diameter Pole

| ITEM # | COLOR | 1-23 | 24-143 | 144+ | LBS. |
|--------|-------|--------|--------|--------|------|
| 310050 | GRAY | \$2.60 | \$2.18 | \$2.12 | .04 |



ALUMINUM MULTI-PURPOSE BRACKETS

Supplied with Thumb Screw • Displays Pole at 45° or Horizontal • For 1" Dia. Poles

| ITEM # | MODEL | COLOR | 1-23 | 24-143 | 144+ | LBS. |
|--------|-------|--------|---------|---------|---------|------|
| 310052 | MPB | SILVER | \$23.80 | \$21.10 | \$20.40 | .50 |
| 310053 | MPB-W | WHITE | 27.20 | 24.50 | 23.50 | .50 |
| 310054 | MPB-G | GOLD | 34.80 | 31.20 | 29.30 | .50 |
| 310141 | MPB-B | BLACK | 29.40 | 25.30 | 23.30 | .50 |



NYLON MULTI-PURPOSE BRACKETS

Supplied with Thumb Screw • Displays Pole at 45° or Horizontal • For 1" Dia. Poles

| ITEM # | COLOR | 1-23 | 24-143 | 144+ | LBS. |
|--------|-------|--------|--------|--------|------|
| 310055 | WHITE | \$8.90 | \$7.50 | \$6.90 | .25 |



ALUMINUM MULTI-ANGLE BRACKETS

Supplied with Set Screws • Displays Pole at Vertical, 45° or Horizontal • For 1" Dia. Poles

| ITEM # | COLOR | 1-23 | 24-143 | 144+ | LBS. |
|--------|-------|---------|---------|---------|------|
| 310134 | GOLD | \$63.50 | \$51.50 | \$50.00 | .65 |



STAINLESS STEEL MOUNTING STRAPS

| ITEM # | MODEL | FOR POLE DIA. | LENGTH | 1-23 | 24-143 | 144+ | LBS. |
|--------|--------|---------------|---------|---------|--------|--------|------|
| 310074 | SSS-85 | 8-1/2" | 27-3/4" | \$10.10 | \$7.80 | \$6.60 | .18 |
| 310075 | SSS-12 | 12" | 39-1/2" | 14.50 | 11.20 | 10.40 | .20 |
| 310140 | SSS-16 | 16" | 52" | 18.20 | 14.30 | 13.30 | .40 |



ALUMINUM SCHOOL BRACKET

Displays Pole at 45° • For Pole Diameters of 1/4" thru 5/8"

| ITEM # | COLOR | 1-23 | 24-143 | 144+ | LBS. |
|--------|--------|--------|--------|--------|------|
| 310082 | SILVER | \$4.38 | \$3.68 | \$3.50 | .05 |





STAMPED STEEL BRACKETS

Displays Pole at a 45° Angle

| MODEL | FOR POLE DIA. | LBS. | SILVER | | | GOLD | | | | |
|----------|---------------|------|--------|--------|--------|--------|--------|--------|--------|--------|
| | | | ITEM # | 1-71 | 72-143 | 144+ | ITEM # | 1-71 | 72-143 | 144+ |
| SSB-12 | 1/2" | .10 | 310056 | \$3.86 | \$2.86 | \$2.68 | 310060 | \$4.76 | \$3.96 | \$3.80 |
| SSB-34 | 3/4" | .16 | — | — | — | — | 310061 | 5.28 | 4.26 | 4.08 |
| SSB-34HD | 3/4" | .25 | 310151 | 5.60 | 4.70 | 4.50 | — | — | — | — |
| SSB-10 | 1" | .36 | 310058 | 8.20 | 6.50 | 6.20 | 310062 | 10.30 | 8.50 | 7.90 |
| SSB-114 | 1-1/4" | .37 | 310059 | 13.00 | 9.10 | 8.40 | 310063 | 15.00 | 11.20 | 10.70 |



310065 310136

WB ALUMINUM BRACKETS

Displays Pole at a 45° Angle • WB-400 Supplied with Thumb Screw

| ITEM # | MODEL | COLOR | FOR POLE DIA. | 1-71 | 72-143 | 144+ | LBS. |
|--------|-----------|--------|---------------|--------|--------|--------|------|
| 310064 | WB-100 | SILVER | 1/2" | \$9.30 | \$7.50 | \$7.00 | .10 |
| 310065 | WB-200 S | SILVER | 3/4" | 11.70 | 8.50 | 8.20 | .15 |
| 310136 | WB-200 WH | WHITE | 3/4" | 13.60 | 10.70 | 10.40 | .15 |
| 310066 | WB-400 | SILVER | 15/16" - 1" | 16.40 | 14.50 | 13.90 | .30 |



WB CAST BRASS BRACKET

Displays Pole at a 45° Angle • Polished Mirror Finish • Supplied with Set Screw

| ITEM # | MODEL | FOR POLE DIA. | 1-71 | 72-143 | 144+ | LBS. |
|--------|-----------|---------------|---------|---------|---------|------|
| 310124 | WB-200-CB | 3/4" | \$42.50 | \$39.00 | \$33.00 | .50 |
| 310067 | WB-400-CB | 1" | 61.00 | 47.00 | 46.00 | 1.1 |



EWC ALUMINUM BRACKETS

Displays Pole at a 35° Angle • Can Be Mounted with Screws or Stainless Steel Mounting Strap • Supplied with Thumb Screw

| ITEM # | MODEL | COLOR | FOR POLE DIA. | 1-71 | 72-143 | 144+ | LBS. |
|--------|--------|--------|---------------|---------|---------|---------|------|
| 310068 | EWC-S | SILVER | 1" | \$16.40 | \$14.70 | \$14.50 | .45 |
| 310135 | EWC-WH | WHITE | 1" | 19.30 | 17.70 | 16.60 | .45 |



EWC STAINLESS STEEL BRACKETS

Displays Pole at a 30° Angle • Can Be Mounted with Screws or Stainless Steel Mounting Strap • Supplied with Thumb Screw

| ITEM # | FINISH | FOR POLE DIA. | 1-71 | 72-143 | 144+ | LBS. |
|--------|----------|---------------|---------|---------|---------|------|
| 310069 | STANDARD | 1" | \$57.00 | \$53.00 | \$47.00 | 1.2 |
| 310125 | MIRROR | 1" | 66.50 | 55.00 | 52.00 | 1.2 |



ALUMINUM ELECTRIC WAY BRACKET

Displays Pole at a 45° Angle • Supplied with Thumb Screw

| ITEM # | MODEL | COLOR | FOR POLE DIA. | 1-71 | 72-143 | 144+ | LBS. |
|--------|-------|--------|---------------|---------|---------|---------|------|
| 310070 | EWB | SILVER | 1" | \$25.80 | \$20.70 | \$19.20 | .40 |



CAST BRONZE ELECTRIC WAY BRACKET

Displays Pole at a 45° Angle • With Sand Blasted Finish • Supplied with Set Screw

| ITEM # | MODEL | FOR POLE DIA. | 1-71 | 72-143 | 144+ | LBS. |
|--------|--------|---------------|---------|---------|---------|------|
| 310071 | EWB-CB | 1" | \$73.00 | \$63.00 | \$61.00 | .40 |



ALUMINUM ELECTRIC WAY BRACKET STRAPS

To be used with our EWB or EWB-CB brackets on [page 85](#).

| ITEM # | COLOR | FOR POLE DIA. | 1-11 | 12-71 | 72+ | LBS. |
|--------|--------|----------------|---------|---------|---------|------|
| 310072 | SILVER | 6" AND SMALLER | \$65.50 | \$53.50 | \$45.50 | .70 |



25° pictured

WS-100 ALUMINUM WALL SHIELD BRACKETS

Supplied with Set Screw

| ITEM # | ANGLE | COLOR | FOR POLE DIA. | 1-11 | 12+ | LBS. |
|--------|-------|--------|---------------|---------|---------|------|
| 310076 | 25° | SILVER | 15/16" | \$84.00 | \$78.00 | 1.4 |
| 310077 | 25° | SILVER | 1" | 84.00 | 78.00 | 1.4 |
| 310078 | 25° | SILVER | 1-1/8" | 84.00 | 78.00 | 1.4 |
| 310079 | 70° | SILVER | 15/16" | 84.00 | 78.00 | 1.4 |
| 310080 | 70° | SILVER | 1" | 84.00 | 78.00 | 1.4 |
| 310081 | 70° | SILVER | 1-1/8" | 84.00 | 78.00 | 1.4 |



ALUMINUM FINGER BRACKETS

Displays Poles at a 45° Angle

| ITEM # | COLOR | FOR POLE DIA. | STYLE | 1-11 | 12-71 | 72+ | LBS. |
|--------|--------|---------------|---------------|---------|---------|---------|------|
| 310083 | SILVER | 3/8" | HOLDS 3 FLAGS | \$15.20 | \$14.60 | \$13.50 | .15 |
| 310084 | SILVER | 3/8" | HOLDS 5 FLAGS | 18.20 | 17.50 | 15.60 | .20 |



STAMPED STEEL FINGER BRACKETS

Displays Poles at a 45° Angle

| ITEM # | COLOR | FOR POLE DIA. | STYLE | 1-11 | 12-71 | 72+ | LBS. |
|--------|--------|---------------|---------------|--------|--------|--------|------|
| 310085 | SILVER | 3/8" | HOLDS 3 FLAGS | \$8.00 | \$7.60 | \$6.90 | .20 |
| 310086 | SILVER | 3/8" | HOLDS 5 FLAGS | 11.20 | 10.70 | 10.10 | .25 |

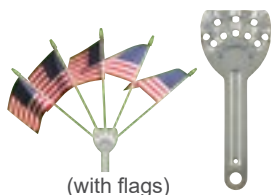

(with flags)

STAMPED STEEL BICYCLE BRACKET

Adjustable to Any Angle • Flags pictured not included in below pricing

| ITEM # | COLOR | FOR POLE DIA. | STYLE | 1-11 | 12-71 | 72+ | LBS. |
|--------|--------|---------------|---------------|--------|--------|--------|------|
| 310087 | SILVER | 3/16" | HOLDS 5 FLAGS | \$3.34 | \$3.18 | \$3.00 | .06 |



PMB-1

PMB-2

PARKING METER BRACKETS

| ITEM # | MODEL | COLOR | FOR POLE DIA. | 1-11 | 12-71 | 72+ | LBS. |
|--------|-------|--------|---------------|---------|---------|---------|------|
| 310088 | PMB-1 | SILVER | 1-3/8" | \$47.50 | \$44.00 | \$41.00 | 1.3 |
| 310089 | PMB-2 | SILVER | 1-3/8" | 76.00 | 73.00 | 63.00 | 1.2 |

ALUMINUM

STEEL

FABRICATED ALUMINUM LAWN SOCKETS

Supplied with Top Cap

| ITEM # | MODEL | TYPE | FOR POLE DIA. | LENGTH | 1-11 | 12-71 | 72+ | LBS. |
|--------|----------|-------------|---------------|--------|---------|---------|---------|------|
| 310102 | ELSF-1 | ALUMINUM | 1" | 10" | \$15.30 | \$11.30 | \$10.40 | .15 |
| 310162 | — | GALV. STEEL | 1" | 9-1/2" | 10.90 | 8.30 | 7.50 | .42 |
| 310103 | ELSF-138 | ALUMINUM | 1-3/8" | 10" | 17.60 | 13.80 | 12.20 | .20 |

CAST ALUMINUM LAWN SOCKETS

Supplied with Top Cap

| ITEM # | MODEL | FOR POLE DIA. | LENGTH | 1-11 | 12-71 | 72+ | LBS. |
|--------|----------|---------------|--------|---------|---------|---------|------|
| 310097 | ELSC-1 | 1" | 10" | \$41.00 | \$39.50 | \$36.50 | .90 |
| 310098 | ELSC-138 | 1-3/8" | 13" | 46.50 | 45.00 | 41.50 | 1.2 |

CAST ALUMINUM CURB SOCKETS

Supplied with Top Cap

| ITEM # | MODEL | FOR POLE DIA. | LENGTH | 1-11 | 12-71 | 72+ | LBS. |
|--------|----------|---------------|--------|---------|---------|---------|------|
| 310099 | ECSC-1 | 1" | 6" | \$41.00 | \$39.50 | \$36.50 | .80 |
| 310100 | ECSC-138 | 1-3/8" | 8-1/2" | 46.50 | 45.00 | 41.50 | .95 |



VERTICAL HOLDERS

Supplied with Thumb Screw

| ITEM # | MODEL | COLOR | FOR POLE DIA. | 1-11 | 12+ | LBS. |
|--------|--------|--------|---------------|---------|---------|------|
| 310090 | VH-1 | SILVER | 1" | \$62.00 | \$56.00 | 2.3 |
| 310091 | RM-138 | SILVER | 1-3/8" | 110.00 | 107.00 | 3.3 |
| 310092 | RM-112 | SILVER | 1-1/2" | 113.00 | 108.00 | 3.4 |
| 310093 | RM-2 | SILVER | 2" | 143.00 | 135.00 | 4.0 |

ALUMINUM TIRE MOUNTS

Supplied with Thumb Screw

| ITEM # | MODEL | COLOR | FOR POLE DIA. | 1-11 | 12+ | LBS. |
|--------|--------|--------|---------------|----------|----------|------|
| 310094 | TM-138 | SILVER | 1-3/8" | \$139.00 | \$136.00 | 3.8 |
| 310095 | TM-112 | SILVER | 1-1/2" | 150.00 | 145.00 | 4.0 |
| 310096 | TM-2 | SILVER | 2" | 188.00 | 179.00 | 4.4 |



WALL MOUNT VERTICAL HOLDER

Supplied with Set Screws

| ITEM # | COLOR | FOR POLE DIA. | PRICE | LBS. |
|--------|------------------------------|---------------|---------|------|
| 460123 | SILVER - BRIGHT ZINC PLATING | 1" | \$85.50 | 1.5 |



CLEAR PLASTIC EZ-MOUNT™ FLAG RINGS

Priced Per Ring

| ITEM # | MODEL | FOR POLE DIA. | 1-11 | 12-71 | 72+ | LBS. |
|--------|---------|---------------|--------|--------|--------|------|
| 310104 | EZ-34 | 3/4" | \$1.56 | \$1.32 | \$1.24 | .02 |
| 310105 | EZ-1516 | 15/16" | 1.56 | 1.32 | 1.24 | .02 |
| 310132 | EZ-78 | 7/8" | 1.56 | 1.32 | 1.24 | .02 |
| 310106 | EZ-1 | 1" | 1.56 | 1.32 | 1.24 | .02 |
| 310107 | EZ-138 | 1-3/8" | 4.06 | 3.58 | 3.28 | .02 |



NYLON FLAG TIES

Priced Per Tie

| ITEM # | MODEL | MAX. POLE DIA. | 1-11 | 12-71 | 72+ | LBS. |
|--------|-------|----------------|--------|--------|--------|------|
| 310110 | NFT4 | 3/4" | \$0.50 | \$0.38 | \$0.30 | .001 |
| 310111 | NFT8 | 2" | 1.00 | 0.84 | 0.66 | .004 |
| 310112 | NFT12 | 3" | 1.32 | 1.12 | 0.88 | .005 |
| 310113 | NFT16 | 4" | 1.50 | 1.26 | 1.06 | .020 |
| 310114 | NFT22 | 6" | 1.70 | 1.50 | 1.22 | .030 |
| 310115 | NFT32 | 9-1/4" | 3.64 | 3.10 | 2.62 | .050 |



BRACKETS, HOLDERS & ACCESSORIES

NEVERFURLS

With NeverFurl® you can fly your flag all day long, every day of the year, and the wind will never wrap your flag around the flagpole. The NeverFurl® kit is easy to install and comes complete with everything needed including instructions and detailed drawings. No additional tools are required.

The design of the NeverFurl® device allows each rotator to work independently with the wind by moving up and down **and** rotating around the pole thereby eliminating flag wrapping. Works with all flag sizes regardless of changes in wind speed or wind direction.



NEVERFURL COMPLETE KITS - WHITE

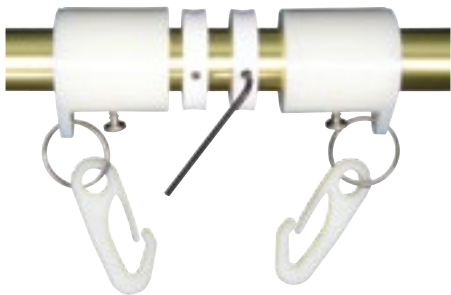

| ITEM # | FOR POLE DIA. | 1-5 | 6+ | LBS. |
|--------|---------------|---------|---------|------|
| 310116 | 3/4" | \$29.60 | \$27.80 | .25 |
| 310117 | 1" | 31.20 | 29.60 | .35 |
| 310118 | 1-1/2" | 41.20 | 39.70 | .40 |
| 310119 | 2" | 45.30 | 41.20 | .45 |
| 310142 | 3" | 85.00 | 79.00 | 1.1 |

NEVERFURL COMPLETE KITS - BLACK

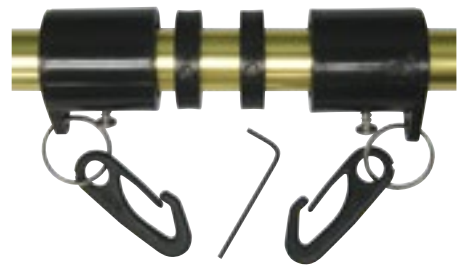

| ITEM # | FOR POLE DIA. | 1-5 | 6+ | LBS. |
|--------|---------------|---------|---------|------|
| 310123 | 3/4" | \$29.60 | \$27.80 | .25 |
| 310137 | 1" | 31.60 | 29.80 | .35 |
| 310152 | 1-1/2" | 45.30 | 41.20 | .40 |

NEVERFURL COLLAR RINGS ONLY - WHITE



| ITEM # | FOR POLE DIA. | PRICE | LBS. |
|--------|---------------|--------|------|
| 310153 | 3/4" | \$7.50 | .02 |
| 310154 | 1" | 7.80 | .03 |
| 310155 | 1-1/2" | 9.10 | .08 |
| 310156 | 2" | 16.30 | .03 |
| 310157 | 3" | 19.90 | .03 |

NEVERFURL COLLAR RINGS ONLY - BLACK



| ITEM # | FOR POLE DIA. | PRICE | LBS. |
|--------|---------------|--------|------|
| 310158 | 3/4" | \$7.80 | .03 |
| 310159 | 1" | 9.10 | .04 |
| 310160 | 1-1/2" | 16.30 | .02 |

NEV-R-WRAP™ FLAG UNFURLERS

No More Tangled Flag • Follows The Wind • Flag Lasts Longer
Comes with 2 nylon flag ties, 2 Nev-R-Wrap tubes and 2 EZ-Mount flag rings

| ITEM # | MODEL | FOR POLE DIA. | 1-11 | 12-71 | 72+ | LBS. |
|--------|----------|---------------|---------|---------|---------|------|
| 310120 | NRV-34 | 3/4" | \$13.30 | \$12.60 | \$11.00 | .10 |
| 310121 | NRV-1516 | 15/16" | 13.30 | 12.60 | 11.00 | .10 |
| 310122 | NRV-1 | 1" | 13.30 | 12.60 | 11.00 | .10 |



ALUMINUM ANTI-FURL ROTATING POLES

These 2-piece poles are available in a brushed aluminum, white painted or wood grain finish. The top of the pole rotates on ball bearings so the flag won't tangle. There's no need for an unfurling tube.

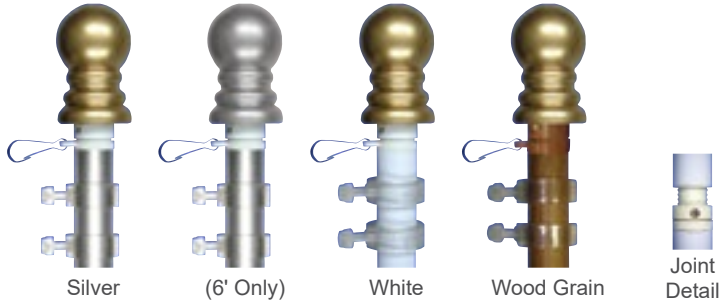

These poles come with 2 flag fasteners (for flying a grommeted flag) and a snap and swivel ring (for flying flags with a pole sleeve and tab). Use with brackets that accept a 1" outside diameter pole (not included).

| ITEM # | LENGTH | FINISH | 1-11 | 12-35 | 36+ | LBS. |
|--------|--------|---------------|---------|---------|---------|------|
| 324174 | 5' | SILVER | \$38.90 | \$36.80 | \$33.40 | 2.1 |
| 324175 | 5' | WHITE | 40.50 | 38.90 | 35.00 | 2.1 |
| 324176 | 5' | WOOD GRAIN | 47.00 | 42.30 | 38.60 | 2.1 |
| 324100 | 6' | SILVER | 39.50 | 38.00 | 35.00 | 2.3 |
| 324207 | 6' | SILVER/SILVER | 39.50 | 38.00 | 35.00 | 2.3 |
| 324105 | 6' | WHITE | 42.30 | 40.50 | 36.80 | 2.3 |
| 324116 | 6' | WOOD GRAIN | 47.00 | 42.50 | 40.50 | 2.3 |

WOOD GRAIN BALL ORNAMENT

Can be purchased separately and switched for standard gold or silver ornament.



| ITEM # | PRICE | LBS. |
|--------|--------|------|
| 324177 | \$7.50 | .13 |

9' X 1" ROTATING POLE W/LAWN SOCKET

This white painted aluminum 2-piece pole includes 2 flag fasteners (for flying a grommeted flag), a snap and swivel ring (for flying flags with a pole sleeve and tab), and a galvanized steel lawn socket. The top of the pole rotates on ball bearings so the flag won't tangle.

| ITEM # | SIZE | 1-11 | 12-35 | 36+ | LBS. |
|--------|---------|---------|---------|---------|------|
| 324178 | 9' x 1" | \$69.80 | \$61.20 | \$58.10 | 3.8 |

1" DIAMETER ALUMINUM DISPLAY POLE SETS

- Includes 2-Piece Aluminum Pole, Gold Vinyl Ball Ornament, 2 Flag Ties & Aluminum Lawn Socket
- Available in Silver Mill or Bright Gold Anodized Finish



| MODEL | ITEM # | LENGTH | COLOR | 1-49 | 50-99 | 100+ | LBS. |
|---------|--------|--------|--------|---------|---------|---------|------|
| BPA600 | 320000 | 6' | SILVER | \$44.50 | \$40.00 | \$39.00 | 1.0 |
| BPA700 | 320001 | 7' | SILVER | 50.50 | 44.50 | 41.50 | 1.1 |
| BPA800 | 320002 | 8' | SILVER | 53.50 | 45.50 | 44.50 | 1.3 |
| BPA900 | 320003 | 9' | SILVER | 54.50 | 50.50 | 45.50 | 1.6 |
| BPA1000 | 320004 | 10' | SILVER | 60.50 | 53.50 | 50.50 | 1.7 |
| BPA600 | 320005 | 6' | GOLD | 54.50 | 49.00 | 45.50 | 1.0 |
| BPA700 | 320006 | 7' | GOLD | 59.50 | 54.50 | 52.00 | 1.1 |
| BPA800 | 320007 | 8' | GOLD | 68.00 | 61.50 | 58.00 | 1.3 |
| BPA900 | 320008 | 9' | GOLD | 69.00 | 63.00 | 61.50 | 1.6 |
| BPA1000 | 320009 | 10' | GOLD | 73.00 | 68.00 | 63.00 | 1.7 |

1" DIAMETER ALUMINUM DISPLAY POLES ONLY

- Poles Only - No other accessories are included.
- Available in Silver Mill Finish or Bright Gold Anodized Finish

| ITEM # | LENGTH | COLOR | TYPE | PRICE | LBS. |
|--------|--------|--------|---------|---------|------|
| 320010 | 3' | SILVER | PLAIN | \$12.30 | .40 |
| 320011 | 3' | SILVER | SWEDGED | 13.60 | .40 |
| 320012 | 4' | SILVER | PLAIN | 14.40 | .55 |
| 320013 | 4' | SILVER | SWEDGED | 15.30 | .55 |
| 320014 | 5' | SILVER | PLAIN | 16.70 | .65 |
| 320015 | 5' | SILVER | SWEDGED | 17.70 | .65 |
| 324184 | 6' | SILVER | PLAIN | 25.00 | .80 |

| ITEM # | LENGTH | COLOR | TYPE | PRICE | LBS. |
|--------|--------|-------|---------|---------|------|
| 320016 | 3' | GOLD | PLAIN | \$19.00 | .40 |
| 320017 | 3' | GOLD | SWEDGED | 19.90 | .40 |
| 320018 | 4' | GOLD | PLAIN | 24.50 | .55 |
| 320019 | 4' | GOLD | SWEDGED | 25.90 | .55 |
| 320020 | 5' | GOLD | PLAIN | 28.40 | .65 |
| 320021 | 5' | GOLD | SWEDGED | 30.20 | .65 |

1" DIAMETER HEAVY WALL ALUMINUM DISPLAY POLES

These clear anodized aluminum tubing sections feature a wall thickness of almost double the wall thickness of our standard aluminum tubing sections.



| ITEM # | LENGTH | COLOR | TYPE | PRICE | LBS. |
|--------|--------|--------|---------|---------|------|
| 324188 | 5' | SILVER | PLAIN | \$23.50 | 1.2 |
| 324189 | 5' | SILVER | SWEDGED | 24.00 | 1.2 |
| 324190 | 6' | SILVER | PLAIN | 29.30 | 1.4 |

OUTDOOR FLAGPOLES



FIBERGLASS 1" DISPLAY POLES - COMPLETE SETS

Includes 1-Piece Fiberglass Pole, Wood Ball Ornament, 2 Flag Ties & Aluminum Lawn Socket

| ITEM # | MODEL | COLOR | LENGTH | DIA. | 1-11 | 12-71 | 72+ | LBS. |
|--------|---------|-------|--------|------|---------|---------|---------|------|
| 320022 | BPPG500 | WHITE | 5' | 1" | \$42.00 | \$39.00 | \$36.50 | 1.6 |
| 320023 | BPPG600 | WHITE | 6' | 1" | 44.50 | 42.00 | 39.00 | 1.8 |
| 320024 | BPPG800 | WHITE | 8' | 1" | 56.00 | 53.50 | 44.50 | 2.3 |

The 10' pole listed below must ship via truck

| | | | | | | | | |
|--------|----------|-------|-----|----|---------|---------|---------|-----|
| 320025 | BPPG1000 | WHITE | 10' | 1" | \$63.00 | \$60.50 | \$53.50 | 2.8 |
|--------|----------|-------|-----|----|---------|---------|---------|-----|

FIBERGLASS 1" DISPLAY POLES - POLES ONLY

No other accessories are included.

| ITEM # | MODEL | COLOR | LENGTH | 1-11 | 12-23 | 24+ | LBS. |
|--------|-------|-------|--------|---------|---------|---------|------|
| 320026 | FPO-5 | WHITE | 5' | \$26.50 | \$23.00 | \$20.00 | 1.3 |
| 320027 | FPO-6 | WHITE | 6' | 28.00 | 24.00 | 22.00 | 1.5 |
| 324080 | FPO-6 | BLACK | 6' | 30.50 | 28.00 | 23.50 | 1.5 |
| 320028 | FPO-8 | WHITE | 8' | 36.50 | 31.50 | 28.00 | 2.0 |

The 10' pole listed below must ship via truck

| | | | | | | | |
|--------|--------|-------|-----|---------|---------|---------|-----|
| 320029 | FPO-10 | WHITE | 10' | \$42.00 | \$37.50 | \$32.50 | 2.5 |
|--------|--------|-------|-----|---------|---------|---------|-----|

COLLAPSIBLE FLAGPOLES TO GO

Acorn Ornament on all Aluminum Poles • Ball Ornament on 16' Fiberglass Pole • All poles are silver including the 16' Fiberglass pole. The clip design allows adjustment for a variety of flag sizes from 1' x 2' through 3' x 5'. It also locks the flag into place.



Fiberglass

Aluminum

| ITEM # | MODEL | TYPE | EXTENDED LENGTH | CLOSED LENGTH | BOTTOM DIA. | TOP DIA. | 1-5 | 6+ | LBS. |
|--------|---------|------------|-----------------|---------------|-------------|----------|---------|---------|------|
| 320031 | FTG-6 | ALUMINUM | 5'-10" | 40" | 5/8" | 1/2" | \$56.00 | \$52.00 | .40 |
| 320032 | FTG-65 | ALUMINUM | 6'-6" | 19" | 1-1/4" | 1/2" | 73.00 | 68.00 | .90 |
| 320033 | FTG-9 | ALUMINUM | 8'-8" | 40" | 3/4" | 1/2" | 63.00 | 61.00 | .66 |
| 320034 | FTG-12 | ALUMINUM | 11'-6" | 40" | 7/8" | 1/2" | 74.00 | 70.00 | .90 |
| 320035 | FTG-15 | ALUMINUM | 14'-4" | 40" | 1" | 1/2" | 101.00 | 96.00 | 1.3 |
| 324180 | FTG-16F | FIBERGLASS | 16'-0" | 51" | 1-5/8" | 3/4" | 138.00 | 133.00 | 2.7 |
| 320037 | FTG-21 | ALUMINUM | 20'-0" | 40" | 1-1/4" | 1/2" | 128.00 | 125.00 | 2.1 |



TAILGATE STANDS FOR FLAGPOLES TO GO

Two-piece design collapses to 2" tall for easy storage. Lightweight aluminum with an enamel coating to prevent oxidizing. Set screw locks pole into place and can hold all sizes of our collapsible poles.

| ITEM # | 1-5 | 6+ | LBS. |
|--------|----------|----------|------|
| 323515 | \$113.00 | \$106.00 | 3.0 |



LAWN-MATE FLAGPOLE

12' all-aluminum ground set flagpole that consists of two 1-3/8" diameter silver anodized, seamless aluminum tubing sections which swedge into each other providing a smooth exterior finish.

STANDARD FITTINGS INCLUDE:

- 2-1/2" gold vinyl ball ornament
- Nylon flag ties for securing flag to pole
- Heavy-duty cast aluminum lawn socket with cap
- Can be shipped via parcel carrier

COMPLETE SET

| ITEM # | FINISH | # OF SECTIONS | 1-11 | 12+ | LBS. |
|--------|--------|---------------|----------|----------|------|
| 320038 | SILVER | 2 | \$128.00 | \$122.00 | 4.1 |

1-3/8" DIAMETER SECTIONS ONLY

| ITEM # | FINISH | LENGTH | DESCRIPTION | PRICE | LBS. |
|--------|--------|--------|-------------|---------|------|
| 320039 | SILVER | 6' | PLAIN | \$44.50 | 1.4 |
| 320040 | SILVER | 6' | SWEDGED | 45.50 | 1.4 |



TELESCOPING FLAGPOLES

Aluminum Flagpoles Available in Exposed Heights of 15', 20' & 25'

FEATURES

- **Rope & Pulley Free:** No tangles or knots
- **Noise Free:** No clanging ropes

- **Maintenance Free:** No Painting, No Rust
- **Sturdy & Durable:** 16 Gauge Aluminum

STANDARD ACCESSORIES

- **Polycarbonate swivel rings:** include a double flag harness for flying two flags
- **Clear polycarbonate pin lock collar:** fits around lowest pole button to prevent unauthorized raising or lowering of the flagpole (collar can be secured with a nut and bolt or a small lock, not included)
- **3" gold anodized aluminum ball:** with 15' and 20' poles (25' pole not supplied with ball ornament, however, we suggest a 4" diameter ball which can be ordered separately.)
- **Heavy duty PVC foundation sleeve**

| MODEL | EXP. HT. | BUTT DIA. | TOP DIA. | LBS. | CLEAR ANODIZED | | | BRONZE ANODIZED | | | BLACK ANODIZED | | | | | |
|-------|----------|-----------|----------|------|----------------|-------|-------|-----------------|--|-------|----------------|-------|--------|-------|-------|-------|
| | | | | | ITEM # | 1-2 | 3-6 | 7+ | ITEM # | 1-2 | 3-6 | 7+ | ITEM # | 1-2 | 3-6 | 7+ |
| T16 | 15' | 2-1/4" | 1-3/4" | 12 | 320083 | \$522 | \$505 | \$486 | 320085 | \$679 | \$660 | \$642 | 320087 | \$610 | \$592 | \$574 |
| T20 | 20' | 2-1/2" | 1-3/4" | 17 | 320084 | 636 | 616 | 600 | 320086 | 712 | 694 | 660 | 320088 | 712 | 694 | 660 |
| T25 | 25' | 3" | 1-3/4" | 28 | 323446 | 910 | 850 | 840 | Note: All exposed heights include the ball ornament and are approximate. | | | | | | | |



SLEEVE CLAMP

Stainless Steel
Prevents Lifting Pole out of Ground Sleeve



ALUMINUM TRAILER HITCH MOUNT

For Standard 2" Square Reese Receiver Hitches



ALUMINUM SIDE MOUNT

Mounts to any Flat or Round Surface

| ITEM # | DESCRIPTION | PRICE | LBS. |
|--------|--------------|---------|------|
| 320091 | FOR 15' POLE | \$58.00 | .30 |
| 320092 | FOR 20' POLE | 58.00 | .30 |

| ITEM # | DESCRIPTION | PRICE | LBS. |
|--------|---------------------|----------|------|
| 323445 | FOR 15* & 20' POLES | \$206.50 | 5.2 |

| ITEM # | DESCRIPTION | PRICE | LBS. |
|--------|---------------------|----------|------|
| 320095 | FOR 15* & 20' POLES | \$250.00 | 3.3 |

* For all mounts on this page, additional insert required for T16 pole. Please specify when ordering.



ALUMINUM WHEEL MOUNT

| ITEM # | DESCRIPTION | PRICE | LBS. |
|--------|---------------------|----------|------|
| 320093 | FOR 15* & 20' POLES | \$259.00 | 12 |



ALUMINUM DOCK MOUNT

| ITEM # | DESCRIPTION | PRICE | LBS. |
|--------|---------------------|----------|------|
| 320094 | FOR 15* & 20' POLES | \$201.00 | 4.7 |

TELESCOPING FLAGPOLE REPLACEMENT PARTS

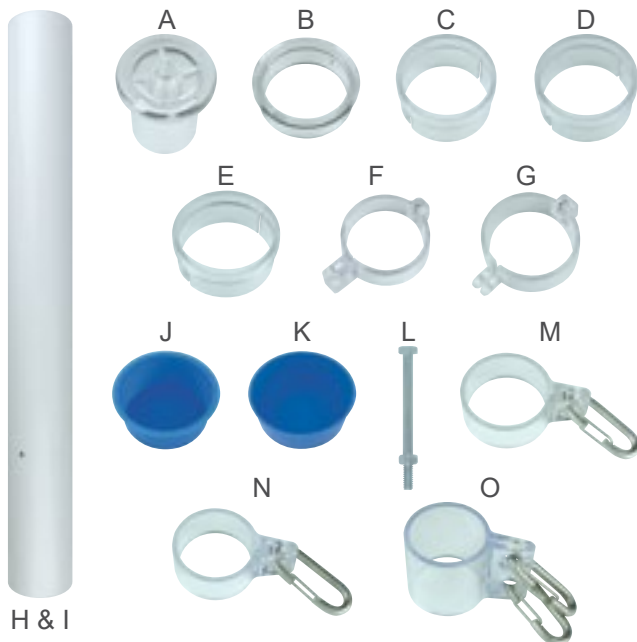

| | ITEM # | DESCRIPTION | FOR POLE SIZE | PRICE | LBS. |
|---|--------|----------------------------|---------------|---------|------|
| A | 320096 | TOP ORNAMENT FITTING | 15', 20' | \$15.50 | .10 |
| B | 320097 | TOP STOP RING | 15', 20' | 9.10 | .05 |
| C | 320098 | SMALL BUSHING | 15', 20' | 9.10 | .05 |
| D | 320099 | MEDIUM BUSHING | 15', 20' | 9.10 | .05 |
| E | 320100 | LARGE BUSHING | 20' | 9.10 | .05 |
| F | 320101 | PIN LOCK | 15' | 21.80 | .05 |
| G | 320102 | PIN LOCK | 20' | 21.80 | .05 |
| H | 320105 | FOUNDATION SLEEVE* | 15' | 36.30 | 1.4 |
| I | 320106 | FOUNDATION SLEEVE* | 20' | 36.30 | 1.4 |
| J | 320107 | FOUNDATION SLEEVE CAP | 15' | 4.60 | .02 |
| K | 320108 | FOUNDATION SLEEVE CAP | 20' | 4.60 | .02 |
| L | 320109 | FOUNDATION SLEEVE PIN BOLT | 15', 20' | 8.52 | .10 |
| M | 320110 | TOP FLAG HARNESS | 15', 20' | 17.60 | .15 |
| N | 320111 | BOTTOM FLAG HARNESS | 15', 20' | 24.50 | .15 |
| O | 320112 | DOUBLE FLAG HARNESS | 15', 20' | 27.80 | .20 |

* Sleeve cap & sleeve pin bolt are supplied with foundation sleeve.

FLY IT FLAGPOLE SETS WITH FLAG

Flagpole consists of powder coated white painted seamless aluminum tubing sections which swedge together providing a smooth exterior finish.

STANDARD FITTINGS INCLUDE:

- Eyebolt & pulley assembly for easy raising & lowering of flag
- Solid braided polypropylene halyard
- 2 nylon flag snaps
- Cast nylon rope cleat with mounting screws
- Gold vinyl ball ornament
- Heavy-duty ground sleeve
- Can be shipped via parcel carrier



| ITEM # | OVERALL LENGTH | BUTT/TOP DIAMETER | # OF SECTIONS | 1-11 | 12-23 | 24+ | LBS. |
|--------|----------------|-------------------|---------------|----------|----------|----------|------|
| 324363 | 18' | 1-5/8" | 4 | \$148.00 | \$140.00 | \$131.00 | 7.2 |

FLY IT – POLE SECTIONS ONLY

| ITEM # | LENGTH | DIA. | FINISH | DESCRIPTION | PRICE | LBS. |
|--------|--------|--------|--------|------------------------------|---------|------|
| 320044 | 48" | 1-3/8" | WHITE | PLAIN - NO DRILLING | \$31.00 | 1.0 |
| 320045 | 48" | 1-3/8" | WHITE | SWEDGED - NO DRILLING | 33.00 | 1.0 |
| 320047 | 54" | 1-5/8" | WHITE | SWEDGED - NO DRILLING | 36.50 | 1.3 |
| 320048 | 54" | 1-5/8" | WHITE | SWEDGED - DRILLED FOR CLEAT | 39.00 | 1.3 |
| 323984 | 54" | 1-5/8" | WHITE | SWEDGED - DRILLED FOR PULLEY | 40.00 | 1.3 |
| 320050 | 66" | 1-3/4" | WHITE | SWEDGED - NO DRILLING | 43.00 | 1.7 |

WHITE TITAN FLAGPOLE SETS

These flagpoles offer exceptional quality at a budget price. The flagpole tubing sections are heavy-duty 19 gauge first run quality steel. The entire inside length of the flagpole is galvanized to prevent rusting while the outside is beautifully finished with a white powder coating. The tubing sections swedge together perfectly to provide a smooth exterior finish.

STANDARD FITTINGS INCLUDE:

- Gold vinyl ball ornament
- Pulley assembly
- Solid braided polypropylene halyard
- 2 nylon flag snaps
- Cast nylon rope cleat with mounting screws
- PVC foundation sleeve
- Easy-to-follow installation instructions
- Can be shipped via parcel carrier

| ITEM # | MODEL | EXPOSED HEIGHT | BUTT/TOP DIAMETER | # OF SECTIONS | 1-11 | 12-23 | 24+ | LBS. |
|--------|-------|----------------|-------------------|---------------|-----------------|-----------------|-----------------|------|
| 323430 | WT12 | 12' | 1-3/8" | 3 | \$150.00 | \$143.00 | \$136.00 | 9.1 |
| 323431 | WT18 | 18' | 1-5/8" | 4 | 185.00 | 170.00 | 167.00 | 14.9 |
| 323432 | WT22 | 22' | 1-3/4" | 5 | 284.00 | 265.00 | 247.00 | 21.4 |



Tubing sections swedge together perfectly providing a smooth exterior finish.

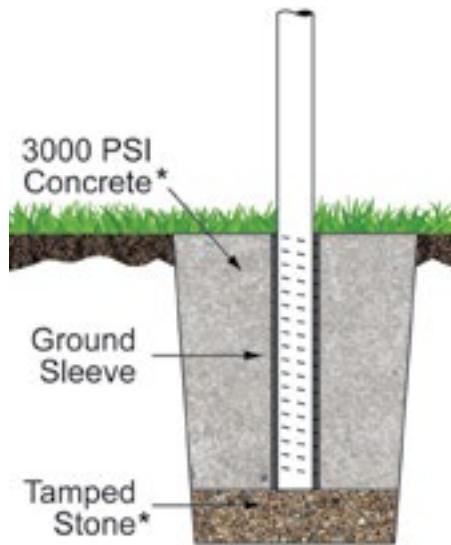

The 12' pole is very popular with tailgaters!...See [page 87](#) for Tire Mount pricing.



HOMESTEADER FLAGPOLE SETS (NO FLAG)

All-aluminum ground set flagpoles available in 10', 15', 20', & 25' exposed heights. The silver anodized, seamless aluminum tubing sections swedge together providing a smooth exterior finish.

STANDARD FITTINGS INCLUDE:

- Gold anodized aluminum ball ornament
- 3" diameter on HS10, HS15 & HS20
- 4" diameter on HS25 & HS20HD
- Cast aluminum truck with pulley
- Solid braided polypropylene halyard
- 2 nylon flag snaps
- Rope cleat with mounting screws
- Cast nylon cleat on HS10, HS15 & HS20
- Cast aluminum cleat on HS20HD & HS25
- Decorative display/storage box
- Heavy-duty ground sleeve
- Can be shipped via parcel carrier

| ITEM # | MODEL | EXPOSED HEIGHT | BUTT/TOP DIAMETER | # OF SECTIONS | 1-5 | 6-11 | 12-23 | 24+ | LBS. |
|--------|--------|----------------|-------------------|---------------|----------|----------|----------|----------|------|
| 320053 | HS10 | 10' | 2" | 2 | \$202.00 | \$199.00 | \$195.00 | \$188.00 | 7.7 |
| 320054 | HS15 | 15' | 2" | 3 | 226.00 | 221.00 | 218.00 | 209.00 | 9.8 |
| 320055 | HS20 | 20' | 2" | 4 | 265.00 | 258.00 | 255.00 | 247.00 | 11.6 |
| 460080 | HS20HD | 20' | 2-1/2" | 5 | 384.00 | 381.00 | 376.00 | 372.00 | 21.1 |
| 320056 | HS25 | 25' | 2-1/2" | 6 | 500.00 | 489.00 | 477.00 | 459.00 | 24.3 |



HOMESTEADER FLASH COLLARS

8" Outside Diameter

2-1/4" High with Clear Anodized Finish



| ITEM # | FOR MODEL # | 1-5 | 6+ | LBS. |
|--------|------------------|---------|---------|------|
| 320064 | HS10, HS15, HS20 | \$46.50 | \$42.00 | .40 |
| 320065 | HS20HD, HS25 | 46.50 | 42.00 | .35 |

HOMESTEADER – POLE SECTIONS ONLY

| ITEM # | FOR POLE MODEL(S) | LENGTH | DIA. | FINISH | DESCRIPTION | PRICE | LBS. |
|--------|-------------------|--------|--------|--------|-----------------------------|---------|------|
| 320057 | HS15, HS20 | 70" | 2" | SILVER | PLAIN - NO DRILLING | \$47.00 | 2.0 |
| 320058 | HS10 | 70" | 2" | SILVER | PLAIN - DRILLED FOR CLEAT | 49.50 | 2.0 |
| 320059 | HS10, HS15, HS20 | 70" | 2" | SILVER | SWEDGED - NO DRILLING | 49.50 | 2.0 |
| 320060 | HS15, HS20 | 70" | 2" | SILVER | SWEDGED - DRILLED FOR CLEAT | 52.00 | 2.0 |
| 320061 | HS20HD, HS25 | 59" | 2-1/2" | SILVER | PLAIN - NO DRILLING | 61.50 | 3.0 |
| 320062 | HS20HD, HS25 | 59" | 2-1/2" | SILVER | SWEDGED - NO DRILLING | 64.00 | 3.0 |
| 320063 | HS20HD, HS25 | 59" | 2-1/2" | SILVER | SWEDGED - DRILLED FOR CLEAT | 67.50 | 3.0 |
| 320068 | HS15-CD, HS20-CD | 56" | 2" | SILVER | PLAIN - NO DRILLING | 40.50 | 1.6 |

20' TAPERED HOMESTEADER FLAGPOLE

With a Butt Diameter of 3" Tapering to a Top Diameter of 2"

All-aluminum ground set flagpole available in 20' exposed height. The silver anodized, seamless aluminum tubing sections swedge together providing a smooth exterior finish.



- Cast nylon rope cleat with mounting screws
- Heavy-duty ground sleeve
- Kraft shipper/storage box can be shipped via parcel carrier
- 3" gold anodized aluminum ball ornament
- Cast aluminum truck with pulley
- Polypropylene halyard with 2 nylon flag snaps
- **Unique swedge and flared-cup design provides a smooth tapering appearance.**



COMPLETE SETS WITH SILVER ANODIZED FINISH

| ITEM # | MODEL | EXPOSED HEIGHT | # OF SECTIONS | 1-2 | 3-6 | 7-12 | 13-49 | 50+ | LBS. |
|--------|-------|----------------|---------------|----------|----------|----------|----------|----------|------|
| 320077 | TH20 | 20' | 5 | \$517.00 | \$500.00 | \$486.00 | \$470.00 | \$425.00 | 19 |

SILVER ANODIZED SECTIONS ONLY

| ITEM # | MODEL | DIA. | LENGTH | DESCRIPTION | PRICE | LBS. |
|--------|-------|--------|--------|---|---------|------|
| 320078 | THS-1 | 3" | 56" | BOTTOM SECTION | \$78.00 | 2.4 |
| 320079 | THS-2 | 3" | 56" | 2 ND FROM BOTTOM - DRILLED FOR CLEAT | 80.00 | 2.4 |
| 320080 | THS-3 | 2-5/8" | 56" | 3 RD FROM BOTTOM SECTION | 75.00 | 2.2 |
| 320081 | THS-4 | 2-1/4" | 56" | 4 TH FROM BOTTOM SECTION | 73.00 | 1.8 |
| 320082 | THS-5 | 2" | 56" | TOP SECTION | 63.00 | 1.7 |



30° Bracket



45° Bracket

10' HOMESTEADER OUTRIGGER FLAGPOLES

Standard accessories include 3" gold anodized aluminum ball ornament, cast aluminum truck with pulley, 30' polypropylene halyard with 2 nylon flag snaps, cast nylon cleat with mounting screws and 30° or 45° mounting bracket (mounting hardware not included). All sets come with two 2" diameter sections and can be shipped via parcel carrier.

COMPLETE SETS WITH SILVER ANODIZED FINISH

| ITEM # | MODEL | DESCRIPTION | 1-5 | 6+ | LBS. |
|--------|----------|---------------|----------|----------|------|
| 320071 | HSO10-30 | w/30° BRACKET | \$350.00 | \$341.00 | 12 |
| 320072 | HSO10-45 | w/45° BRACKET | 345.00 | 331.00 | 10 |

MOUNTING BRACKETS ONLY

| ITEM # | ANGLE | FINISH | 1-5 | 6+ | LBS. |
|--------|-------|--------|----------|----------|------|
| 320073 | 30° | SILVER | \$143.00 | \$137.00 | 3.4 |
| 320074 | 45° | SILVER | 130.00 | 123.00 | 1.1 |





**Partner with Eder Flag ...
the single source provider
with products and service
you can count on.**

- Largest shaft inventory – **Made in U.S.A.**
- Superior service and technical expertise
- **Lifetime Warranty** on aluminum shafts
- Fast shipping
- Competitive pricing





CUSTOM FABRICATION

- Welding capabilities: Aluminum and Steel
- Plasma cutting
- Material cutting equipment
- Ability to polish aluminum tubing up to 45' in length
- Custom machining for various applications
- M-winch repair
- Flagpole and flagpole accessory customizations available upon request

Contact Eder Flag for your special requirements.

TOP PRODUCT: M-WINCH

Easy to use internal halyard winch system

- Maintenance free – No lubrication needed
- Sleek design
- Secure – Requires a key and specialized handle to lower flag
- Quick raising and lowering of flag
- Absence of separate braking system minimizes chance of slippage
- Available in 20' to 130' poles

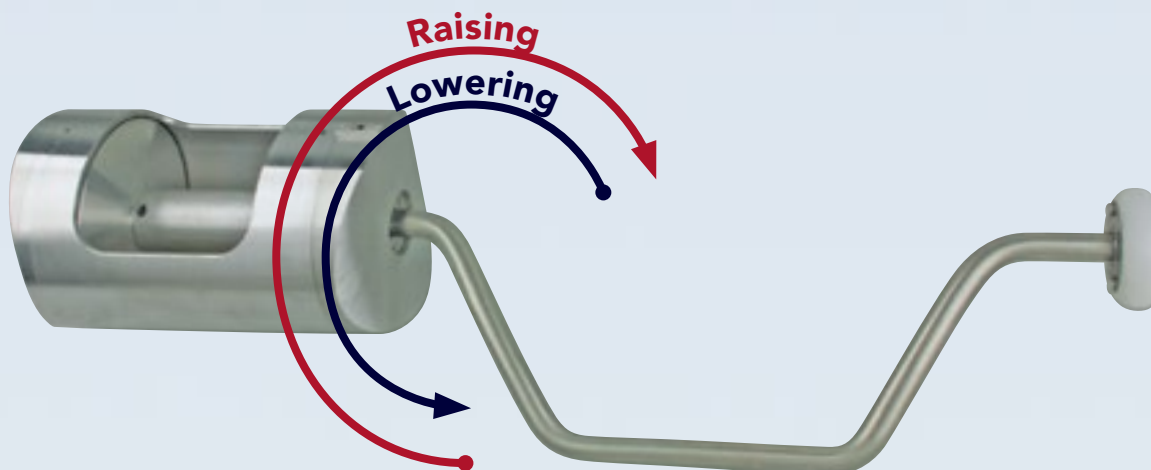

OUTDOOR FLAGPOLES



Our cone tapered ground set aluminum flagpoles are precision fabricated from new, 6063-T6 tubing utilizing the industry's most sophisticated manufacturing processes. The conical portion tapers approximately 1" in every 5-1/2 feet.

All anodized flagpole shafts are highly polished with fine grain aluminum oxide cloth resulting in a high quality, deep satin lustre finish. This finish represents the ultimate in architectural finishes for aluminum flagpoles. The elegant, soft sheen remains maintenance free. See below for anodized finishes available as standard.

STANDARD & ANODIZED FINISHES

For bronze, dark bronze #313 is supplied as standard unless otherwise specified.



Satin



Clear Anodized

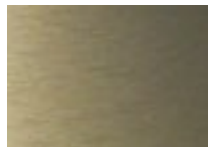

Bronze #311 Anodized (Light)



Bronze #312 Anodized (Medium)



Bronze #313 Anodized (Dark)



Black Anodized (#335)

Custom color powder coating is also available upon request. Please contact us and provide specific RAL # for a prompt quotation.



GROUND SET CONE TAPERED ALUMINUM FLAGPOLES WIND LOAD CHART

The map below shows the maximum steady wind expected at an elevation of thirty feet above ground level within a fifty-year period of recurrence. Areas with the same maximum constant or steady wind speed are indicated.

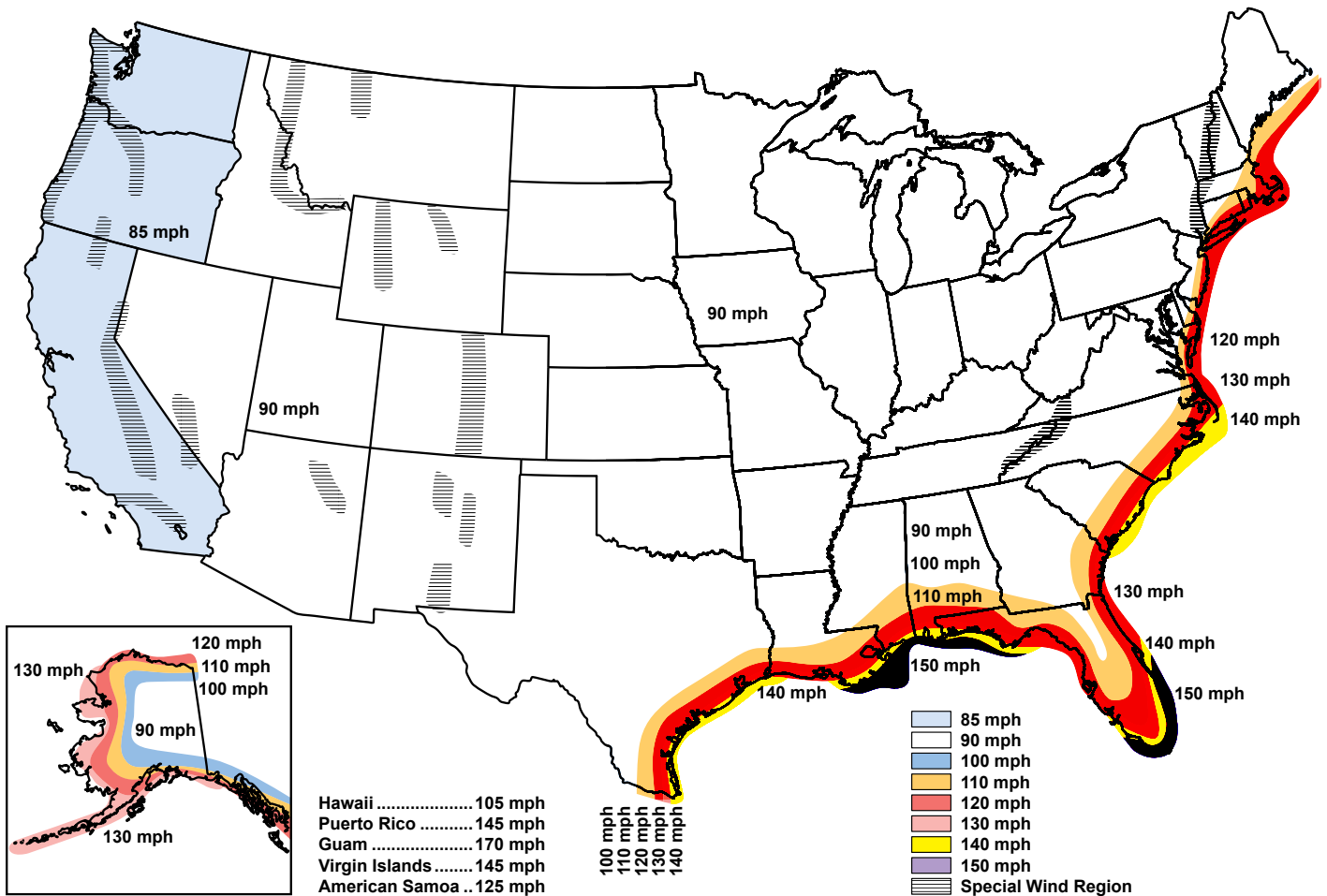

Because wind speeds are usually not constant, and gusts are involved, flagpoles (both flagged and unflagged) are listed in this catalog with a constant wind speed and a 1.3 gust factor.

Flagpoles and their associated wind speeds listed assume that ten percent of the overall length of the flagpole is buried at or near ground level per industry recommendations. Special engineering may be required for other applications such as wall or roof mounted flagpoles. Contact us for a prompt response regarding any situation that may require special engineering.

Safe flagpole design requires knowledge of the loads to which they will be subjected. Principal load acting on flagpoles is wind load and that load must be carefully determined. Maximum wind speeds to which flagpoles are exposed are dependent upon many factors such as geographical location, whether or not it is in the center of a large city, a small town's outskirts, seashore, at ground level or on the roof of a high building. Wind speeds generally are higher along coastal areas than inland. They are also higher in open country than in the center of cities. Wind speed also becomes greater as height above ground increases. Wind exerts a force on the pole as well as the flag, thus both loads must be added to determine total load. Flags of different sizes are designed to be flown from different poles.

It's important that flagpoles be selected which are capable of supporting the largest flag intended to be flown in the highest wind speed to which it will be subjected. Loads on flagpoles are resisted by the mounting foundation, roof, or wall to which it is secured.

- Specified wind speed calculations are based on nylon flag material
- All flagpole design calculations are in accordance with GUIDE SPECIFICATIONS FOR DESIGN LOADS OF METAL FLAGPOLES, ASNI/NAAMM FL 1001-07 Fifth Ed.

PLEASE NOTE: recommended flag sizes throughout this catalog do not represent a warranty that the flag size shown may be safely flown in all wind speeds. Personal injury, flagpole damage or property damage can occur when flying oversized flags and banners or flying flags in higher winds than recommended.

OUTDOOR FLAGPOLES | Architectural

ARCHITECTURAL SERIES

External Halyard Ground Set Cone Tapered Aluminum Flagpoles

STANDARD ACCESSORIES

- Gold anodized aluminum ball ornament
- Cast aluminum revolving truck w/pulley
- Solid braided polyester halyard
- Swivel flag snaps w/vinyl snap covers
- Cast aluminum cleat with mounting screws
- Spun aluminum flash collar
- Galvanized steel foundation sleeve

| MODEL | EXPOSED HEIGHT | OVERALL LENGTH | # OF SECTIONS | BUTT DIA. | TOP DIA. | WALL | UNFLAGGED MAX. WIND SPEED | FLAGGED MAX. WIND SPEED | SUGGESTED FLAG SIZE | SHIPPING WEIGHT |
|-------|----------------|----------------|---------------|-----------|----------|------|---------------------------|-------------------------|---------------------|-----------------|
| EC20 | 20' | 23' | 1 | 5" | 3" | .188 | 315 MPH | 120+ MPH | 3' x 5' | 137 lbs. |
| EC25 | 25' | 27' | 1 | 6" | 3-1/2" | .188 | 250 MPH | 120+ MPH | 4' x 6' | 195 lbs. |
| EC30 | 30' | 33' | 1 or 2* | 6" | 3-1/2" | .188 | 211 MPH | 120+ MPH | 5' x 8' | 227 lbs. |
| EC35 | 35' | 38-1/2' | 1 or 2* | 7" | 3-1/2" | .188 | 202 MPH | 120 MPH | 6' x 10' | 271 lbs. |
| EC40 | 40' | 44' | 2** | 8" | 3-1/2" | .188 | 203 MPH | 120 MPH | 8' x 12' | 311 lbs. |
| EC45 | 45' | 49-1/2' | 2** | 8" | 3-1/2" | .188 | 166 MPH | 100 MPH | 8' x 12' | 361 lbs. |
| EC50 | 50' | 55' | 3** | 10" | 4" | .188 | 185 MPH | 115 MPH | 10' x 15' | 513 lbs. |
| EC60 | 60' | 66' | 3** | 12" | 4" | .250 | 213 MPH | 120 MPH | 12' x 18' | 833 lbs. |
| EC70 | 70' | 77' | 3** | 12" | 4" | .250 | 169 MPH | 105 MPH | 15' x 25' | 978 lbs. |
| EC80 | 80' | 88' | 3** | 12" | 4" | .375 | 174 MPH | 105 MPH | 20' x 30' | 1357 lbs. |

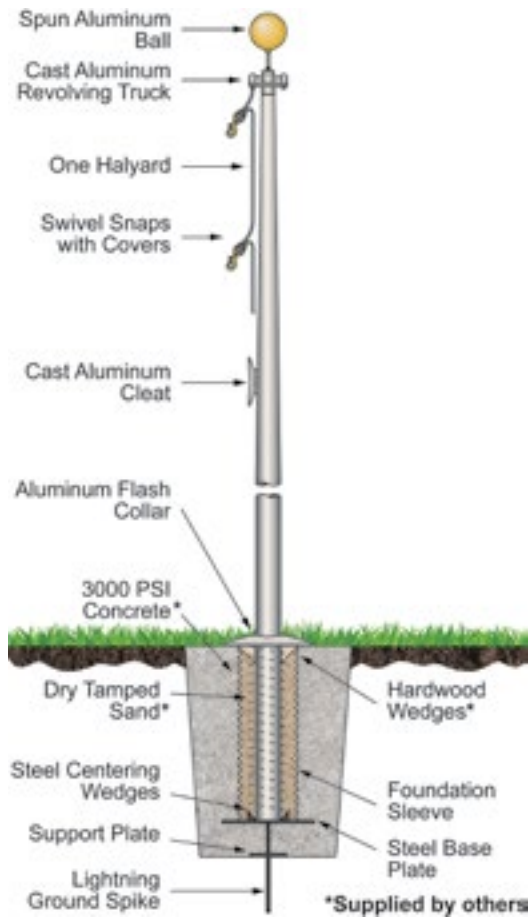

* Flagpole models available in both one and two section styles; please specify when placing your order. Single section pole(s) will be shipped if not specified. **Add 10% to the pricing for two section style flagpoles.**

** Flagpole models available in multi-piece pole(s) only.

SATIN

| MODEL | ITEM # | 1-2 | 3-6 | 7+ |
|-------|--------|---------|---------|---------|
| EC20 | 320113 | \$2,390 | \$2,270 | \$2,170 |
| EC25 | 320114 | 3,020 | 2,930 | 2,740 |
| EC30 | 320115 | 3,380 | 3,270 | 3,030 |
| EC35 | 320116 | 4,550 | 4,280 | 4,070 |
| EC40 | 320117 | 5,840 | 5,640 | 5,370 |
| EC45 | 320118 | 6,600 | 6,280 | 5,960 |
| EC50 | 320119 | 8,940 | 8,520 | 8,100 |
| EC60 | 320120 | 17,350 | 16,470 | 15,630 |
| EC70 | 320121 | 19,540 | 18,590 | 17,590 |
| EC80 | 320122 | 24,390 | 23,360 | 22,150 |

CLEAR ANODIZED

| MODEL | ITEM # | 1-2 | 3-6 | 7+ |
|-------|--------|---------|---------|---------|
| EC20 | 320123 | \$2,910 | \$2,790 | \$2,610 |
| EC25 | 320124 | 3,700 | 3,480 | 3,330 |
| EC30 | 320125 | 4,130 | 3,940 | 3,700 |
| EC35 | 320126 | 5,500 | 5,280 | 4,950 |
| EC40 | 320127 | 7,150 | 6,780 | 6,410 |
| EC45 | 320128 | 7,920 | 7,530 | 7,100 |
| EC50 | 320129 | 11,090 | 10,550 | 9,960 |
| EC60 | 320130 | 19,920 | 18,920 | 17,920 |
| EC70 | 320131 | 22,480 | 21,370 | 20,230 |
| EC80 | 320132 | 28,500 | 27,040 | 25,670 |

BRONZE ANODIZED

| MODEL | ITEM # | 1-2 | 3-6 | 7+ |
|-------|--------|---------|---------|---------|
| EC20 | 320133 | \$2,980 | \$2,870 | \$2,700 |
| EC25 | 320134 | 3,740 | 3,600 | 3,380 |
| EC30 | 320135 | 4,220 | 4,010 | 3,810 |
| EC35 | 320136 | 5,660 | 5,360 | 5,060 |
| EC40 | 320137 | 7,340 | 6,990 | 6,620 |
| EC45 | 320138 | 8,170 | 7,730 | 7,340 |
| EC50 | 320139 | 11,420 | 10,890 | 10,290 |
| EC60 | 320140 | 20,390 | 19,370 | 18,340 |
| EC70 | 320141 | 23,050 | 21,850 | 20,690 |
| EC80 | 320142 | 29,060 | 27,630 | 26,070 |

BLACK ANODIZED

| MODEL | ITEM # | 1-2 | 3-6 | 7+ |
|-------|--------|---------|---------|---------|
| EC20 | 320143 | \$3,140 | \$2,960 | \$2,780 |
| EC25 | 320144 | 3,980 | 3,800 | 3,590 |
| EC30 | 320145 | 4,500 | 4,280 | 4,030 |
| EC35 | 320146 | 5,930 | 5,620 | 5,310 |
| EC40 | 320147 | 7,730 | 7,340 | 6,960 |
| EC45 | 320148 | 8,620 | 8,180 | 7,730 |
| EC50 | 320149 | 12,060 | 11,410 | 10,860 |
| EC60 | 320150 | 21,140 | 20,060 | 18,980 |
| EC70 | 320151 | 23,940 | 22,680 | 21,510 |
| EC80 | 320152 | 30,100 | 28,630 | 27,060 |

Add \$60.00 to any of the flagpole pricing above for double-cleat/double-halyard flagpoles.

HURRICANE SERIES FLAGPOLES

External Halyard Ground Set Cone Tapered Aluminum Flagpoles

STANDARD EXTERNAL POLE ACCESSORIES

- Gold anodized aluminum ball ornament
- Cast aluminum revolving truck w/pulley
- Solid braided polyester halyard
- Swivel flag snaps w/vinyl snap covers
- Cast aluminum cleat with mounting screws
- Spun aluminum flash collar
- Galvanized steel foundation sleeve

Increased Wall Thickness or Butt Diameter Make Our Hurricane Series Flagpoles the Best Choice for High Wind Locations

| MODEL | EXPOSED HEIGHT | OVERALL LENGTH | # OF SECTIONS | BUTT DIA. | TOP DIA. | WALL | UNFLAGGED MAX. WIND SPEED | FLAGGED MAX. WIND SPEED | SUGGESTED FLAG SIZE | SHIPPING WEIGHT |
|-------|----------------|----------------|---------------|-----------|----------|------|---------------------------|-------------------------|---------------------|-----------------|
| ECH25 | 25' | 27' | 1 | 6" | 3-1/2" | .250 | 255 MPH | 150+ MPH | 4' x 6' | 239 lbs. |
| ECH30 | 30' | 33' | 2 | 6" | 3-1/2" | .250 | 241 MPH | 150+ MPH | 5' x 8' | 322 lbs. |
| ECH35 | 35' | 38-1/2' | 2 | 8" | 3-1/2" | .250 | 255 MPH | 150 MPH | 6' x 10' | 351 lbs. |
| ECH40 | 40' | 44' | 2 | 8" | 3-1/2" | .250 | 231 MPH | 150 MPH | 8' x 12' | 399 lbs. |
| ECH50 | 50' | 55' | 3 | 10" | 4" | .312 | 230 MPH | 150 MPH | 10' x 15' | 661 lbs. |

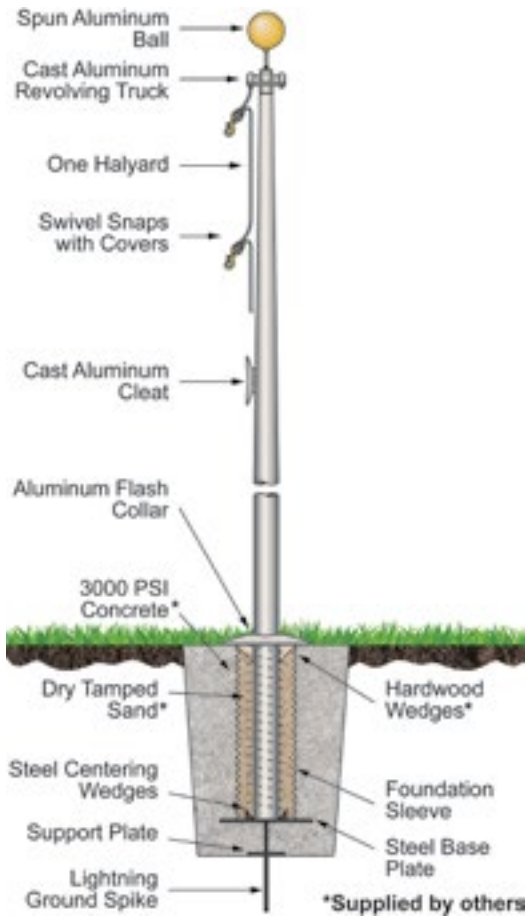

SATIN

| MODEL | ITEM # | 1-2 | 3-6 | 7+ |
|-------|--------|---------|---------|---------|
| ECH25 | 324117 | \$4,080 | \$3,890 | \$3,740 |
| ECH30 | 324118 | 5,580 | 5,370 | 5,110 |
| ECH35 | 324119 | 6,260 | 5,960 | 5,740 |
| ECH40 | 324120 | 7,240 | 6,930 | 6,650 |
| ECH50 | 324121 | 13,580 | 13,060 | 12,540 |

CLEAR ANODIZED

| MODEL | ITEM # | 1-2 | 3-6 | 7+ |
|-------|--------|---------|---------|---------|
| ECH25 | 324122 | \$4,680 | \$4,490 | \$4,210 |
| ECH30 | 324123 | 6,410 | 6,110 | 5,890 |
| ECH35 | 324124 | 7,330 | 6,990 | 6,730 |
| ECH40 | 324125 | 8,550 | 8,210 | 7,910 |
| ECH50 | 324126 | 15,560 | 14,950 | 14,320 |

BRONZE ANODIZED

| MODEL | ITEM # | 1-2 | 3-6 | 7+ |
|-------|--------|---------|---------|---------|
| ECH25 | 324127 | \$4,870 | \$4,680 | \$4,490 |
| ECH30 | 324128 | 6,540 | 6,260 | 6,040 |
| ECH35 | 324129 | 7,630 | 7,340 | 7,000 |
| ECH40 | 324130 | 8,840 | 8,490 | 8,170 |
| ECH50 | 324131 | 16,090 | 15,470 | 14,830 |

BLACK ANODIZED

| MODEL | ITEM # | 1-2 | 3-6 | 7+ |
|-------|--------|---------|---------|---------|
| ECH25 | 324132 | \$5,100 | \$4,920 | \$4,710 |
| ECH30 | 324133 | 6,790 | 6,600 | 6,260 |
| ECH35 | 324134 | 8,070 | 7,730 | 7,480 |
| ECH40 | 324135 | 9,350 | 8,950 | 8,630 |
| ECH50 | 324136 | 16,790 | 16,170 | 15,480 |

Add \$60.00 to any of the flagpole pricing above for double-cleat/double-halyard flagpoles.

OUTDOOR FLAGPOLES | Economy Extra

ECONOMY EXTRA SERIES

External Halyard Ground Set Cone Tapered Aluminum Flagpoles

STANDARD ACCESSORIES

- Gold anodized aluminum ball ornament
- Cast aluminum revolving truck w/pulley
- Solid braided polyester halyard
- Swivel flag snaps w/vinyl snap covers
- Cast aluminum cleat with mounting screws
- Spun aluminum flash collar
- Galvanized steel foundation sleeve

| MODEL | EXPOSED HEIGHT | OVERALL LENGTH | # OF SECTIONS | BUTT DIA. | TOP DIA. | WALL | UNFLAGGED MAX. WIND SPEED | FLAGGED MAX. WIND SPEED | SUGGESTED FLAG SIZE | SHIPPING WEIGHT |
|-------|----------------|----------------|---------------|-----------|----------|------|---------------------------|-------------------------|---------------------|-----------------|
| ECX20 | 20' | 23' | 1 | 5" | 3" | .125 | 255 MPH | 120+ MPH | 3' x 5' | 119 lbs. |
| ECX25 | 25' | 27' | 1 | 5" | 3" | .125 | 137 MPH | 105 MPH | 4' x 6' | 129 lbs. |
| ECX30 | 30' | 33' | 1 or 2* | 5" | 3" | .125 | 104 MPH | 85 MPH | 5' x 8' | 154 lbs. |
| ECX35 | 35' | 38-1/2' | 1 or 2* | 6" | 3-1/2" | .156 | 119 MPH | 91 MPH | 6' x 10' | 237 lbs. |
| ECX40 | 40' | 44' | 2** | 7" | 3-1/2" | .156 | 122 MPH | 91 MPH | 8' x 12' | 272 lbs. |
| ECX50 | 50' | 55' | 3** | 8" | 3-1/2" | .188 | 118 MPH | 85 MPH | 10' x 15' | 433 lbs. |
| ECX60 | 60' | 66' | 3** | 10" | 4" | .188 | 122 MPH | 90 MPH | 12' x 18' | 665 lbs. |
| ECX70 | 70' | 77' | 3** | 10" | 4" | .312 | 127 MPH | 91 MPH | 15' x 25' | 1032 lbs. |

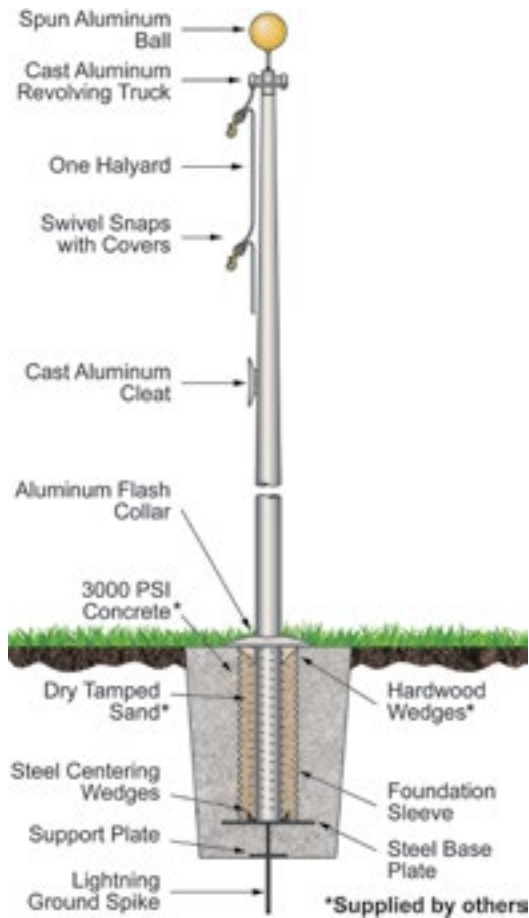

* Flagpole models available in both one and two section styles; please specify when placing your order. Single section pole(s) will be shipped if not specified. **Add 10% to the pricing for two section style flagpoles.**

** Flagpole models available in multi-piece pole(s) only.

SATIN

| MODEL | ITEM # | 1-2 | 3-6 | 7+ |
|-------|--------|---------|---------|---------|
| ECX20 | 320193 | \$1,910 | \$1,800 | \$1,670 |
| ECX25 | 320194 | 1,990 | 1,910 | 1,790 |
| ECX30 | 320195 | 2,210 | 2,130 | 1,990 |
| ECX35 | 320196 | 3,430 | 3,270 | 3,020 |
| ECX40 | 320197 | 5,020 | 4,770 | 4,500 |
| ECX50 | 320198 | 7,120 | 6,740 | 6,370 |
| ECX60 | 320199 | 10,320 | 9,970 | 9,280 |
| ECX70 | 320200 | 16,550 | 15,730 | 14,890 |

CLEAR ANODIZED

| MODEL | ITEM # | 1-2 | 3-6 | 7+ |
|-------|--------|---------|---------|---------|
| ECX20 | 320201 | \$2,320 | \$2,230 | \$2,120 |
| ECX25 | 320202 | 2,530 | 2,390 | 2,230 |
| ECX30 | 320203 | 2,840 | 2,720 | 2,600 |
| ECX35 | 320204 | 4,210 | 4,000 | 3,800 |
| ECX40 | 320205 | 5,970 | 5,760 | 5,410 |
| ECX50 | 320206 | 8,560 | 8,160 | 7,720 |
| ECX60 | 320207 | 12,420 | 11,810 | 11,190 |
| ECX70 | 320208 | 19,350 | 18,390 | 17,360 |

BRONZE ANODIZED

| MODEL | ITEM # | 1-2 | 3-6 | 7+ |
|-------|--------|---------|---------|---------|
| ECX20 | 320209 | \$2,400 | \$2,260 | \$2,150 |
| ECX25 | 320210 | 2,580 | 2,440 | 2,290 |
| ECX30 | 320211 | 2,870 | 2,760 | 2,580 |
| ECX35 | 320212 | 4,320 | 4,120 | 3,870 |
| ECX40 | 320213 | 6,250 | 5,920 | 5,610 |
| ECX50 | 320214 | 8,850 | 8,380 | 7,930 |
| ECX60 | 320215 | 12,850 | 12,220 | 11,520 |
| ECX70 | 320216 | 19,750 | 18,770 | 17,800 |

BLACK ANODIZED

| MODEL | ITEM # | 1-2 | 3-6 | 7+ |
|-------|--------|---------|---------|---------|
| ECX20 | 320217 | \$2,540 | \$2,390 | \$2,240 |
| ECX25 | 320218 | 2,750 | 2,590 | 2,400 |
| ECX30 | 320219 | 3,080 | 2,960 | 2,780 |
| ECX35 | 320220 | 4,620 | 4,370 | 4,120 |
| ECX40 | 320221 | 6,530 | 6,220 | 5,820 |
| ECX50 | 320222 | 9,250 | 8,780 | 8,340 |
| ECX60 | 320223 | 13,470 | 12,830 | 12,110 |
| ECX70 | 320224 | 20,520 | 19,530 | 18,450 |

Add \$60.00 to any of the flagpole pricing above for double-cleat/double-halyard flagpoles.

ATLAS SERIES

External Halyard Ground Set Cone Tapered Aluminum Flagpoles

STANDARD ACCESSORIES

- Gold anodized aluminum ball ornament
- Cast aluminum revolving truck with pulley (ECSA20 & ECSA25 poles have a stationary truck as standard)
- Solid braided polyester halyard
- Swivel flag snaps w/vinyl snap covers
- Cast aluminum cleat with mounting screws
- Spun aluminum flash collar
- Galvanized steel foundation sleeve

| MODEL | EXPOSED HEIGHT | OVERALL LENGTH | # OF SECTIONS | BUTT DIA. | TOP DIA. | WALL | UNFLAGGED MAX. WIND SPEED | FLAGGED MAX. WIND SPEED | SUGGESTED FLAG SIZE | SHIPPING WEIGHT |
|--------|----------------|----------------|---------------|-----------|----------|------|---------------------------|-------------------------|---------------------|-----------------|
| ECSA20 | 20' | 22' | 1 | 4" | 2-3/8" | .125 | 152 MPH | 110 MPH | 3' x 5' | 92 lbs. |
| ECSA25 | 25' | 27' | 1 | 4" | 2-3/8" | .125 | 113 MPH | 88 MPH | 4' x 6' | 112 lbs. |
| ECXA25 | 25' | 27' | 1 | 5" | 3" | .156 | 183 MPH | 120 MPH | 4' x 6' | 147 lbs. |
| ECXA30 | 30' | 33' | 1 or 2* | 5" | 3" | .156 | 119 MPH | 95 MPH | 5' x 8' | 162 lbs. |
| ECL30 | 30' | 33' | 1 | 5" | 3" | .188 | 131 MPH | 100 MPH | 5' x 8' | 180 lbs. |
| ECA30 | 30' | 33' | 1 or 2* | 6" | 3-1/2" | .156 | 184 MPH | 115 MPH | 5' x 8' | 218 lbs. |
| ECSA35 | 35' | 38-1/2' | 1 | 5" | 3" | .188 | 104 MPH | 86 MPH | 6' x 10' | 228 lbs. |
| ECA35 | 35' | 38-1/2' | 1 or 2* | 7" | 3-1/2" | .156 | 175 MPH | 114 MPH | 6' x 10' | 251 lbs. |
| ECA40 | 40' | 44' | 2** | 8" | 3-1/2" | .156 | 171 MPH | 110 MPH | 8' x 12' | 298 lbs. |
| ECXA60 | 60' | 66' | 3** | 10" | 4" | .250 | 150 MPH | 106 MPH | 12' x 18' | 754 lbs. |

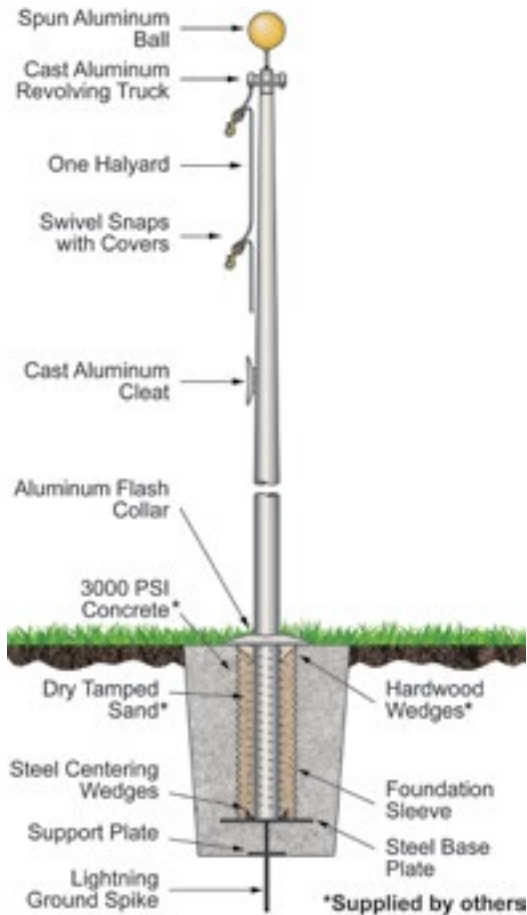

Note: the ECSA20 and ECSA25 flagpoles are not supplied with a plate support or centering wedges.

* Flagpole models available in both one and two section styles; please specify when placing your order. Single section pole(s) will be shipped if not specified. **Add 10% to the pricing for two section style flagpoles.**

** Flagpole models available in multi-piece pole(s) only.

SATIN

| MODEL | ITEM # | 1-2 | 3-6 | 7+ |
|--------|--------|---------|---------|---------|
| ECSA20 | 320337 | \$1,310 | \$1,250 | \$1,170 |
| ECSA25 | 320338 | 1,400 | 1,330 | 1,250 |
| ECXA25 | 320339 | 2,380 | 2,210 | 2,110 |
| ECXA30 | 320340 | 2,680 | 2,530 | 2,390 |
| ECL30 | 320884 | 2,860 | 2,720 | 2,580 |
| ECA30 | 320341 | 3,290 | 3,130 | 2,950 |
| ECSA35 | 320342 | 2,980 | 2,840 | 2,670 |
| ECA35 | 320343 | 3,910 | 3,680 | 3,500 |
| ECA40 | 320344 | 5,730 | 5,530 | 5,250 |
| ECXA60 | 320345 | 13,080 | 12,500 | 11,790 |

CLEAR ANODIZED

| MODEL | ITEM # | 1-2 | 3-6 | 7+ |
|--------|--------|---------|---------|---------|
| ECSA20 | 320346 | \$1,670 | \$1,590 | \$1,490 |
| ECSA25 | 320347 | 1,800 | 1,710 | 1,640 |
| ECXA25 | 320348 | 2,870 | 2,760 | 2,590 |
| ECXA30 | 320349 | 3,220 | 3,080 | 2,890 |
| ECL30 | 320885 | 3,350 | 3,220 | 3,000 |
| ECA30 | 320350 | 4,000 | 3,810 | 3,590 |
| ECSA35 | 320351 | 3,700 | 3,530 | 3,340 |
| ECA35 | 320352 | 4,840 | 4,570 | 4,320 |
| ECA40 | 320353 | 7,040 | 6,680 | 6,290 |
| ECXA60 | 320354 | 15,410 | 14,650 | 13,890 |

BRONZE ANODIZED

| MODEL | ITEM # | 1-2 | 3-6 | 7+ |
|--------|--------|---------|---------|---------|
| ECSA20 | 320355 | \$1,750 | \$1,660 | \$1,560 |
| ECSA25 | 320356 | 1,920 | 1,790 | 1,670 |
| ECXA25 | 320357 | 3,010 | 2,860 | 2,720 |
| ECXA30 | 320358 | 3,380 | 3,190 | 3,030 |
| ECL30 | 320886 | 3,520 | 3,340 | 3,170 |
| ECA30 | 320359 | 4,120 | 3,920 | 3,710 |
| ECSA35 | 320360 | 3,750 | 3,570 | 3,420 |
| ECA35 | 320361 | 4,960 | 4,730 | 4,440 |
| ECA40 | 320362 | 7,220 | 6,880 | 6,510 |
| ECXA60 | 320363 | 15,750 | 14,950 | 14,240 |

BLACK ANODIZED

| MODEL | ITEM # | 1-2 | 3-6 | 7+ |
|--------|--------|---------|---------|---------|
| ECSA20 | 320364 | \$1,840 | \$1,750 | \$1,650 |
| ECSA25 | 320365 | 2,020 | 1,940 | 1,800 |
| ECXA25 | 320366 | 3,080 | 2,940 | 2,780 |
| ECXA30 | 320367 | 3,500 | 3,330 | 3,090 |
| ECL30 | 320887 | 3,600 | 3,430 | 3,230 |
| ECA30 | 320368 | 4,290 | 4,110 | 3,830 |
| ECSA35 | 320369 | 3,990 | 3,750 | 3,570 |
| ECA35 | 320370 | 5,230 | 4,970 | 4,730 |
| ECA40 | 320371 | 7,610 | 7,220 | 6,860 |
| ECXA60 | 320372 | 16,430 | 15,610 | 14,750 |

Add \$60.00 to any of the flagpole pricing above for double-cleat/double-halyard flagpoles.

OUTDOOR FLAGPOLES | Special Budget

SPECIAL BUDGET SERIES

External Halyard Ground Set Cone Tapered Aluminum Flagpoles

STANDARD ACCESSORIES

- Gold anodized aluminum ball ornament
- Cast aluminum stationary truck w/pulley (ECS35 has a revolving truck as standard)
- Solid braided polyester halyard
- Cast aluminum cleat with mounting screws
- Metal swivel flag snaps w/vinyl covers
- Flash collar not included as standard equipment for this series
- PVC foundation sleeve (ECS30 & ECS35 poles have a galvanized steel sleeve as standard)

| MODEL | EXPOSED HEIGHT | OVERALL LENGTH | # OF SECTIONS | BUTT DIA. | TOP DIA. | WALL | UNFLAGGED MAX. WIND SPEED | FLAGGED MAX. WIND SPEED | SUGGESTED FLAG SIZE | SHIPPING WEIGHT |
|--------|----------------|----------------|---------------|-----------|----------|------|---------------------------|-------------------------|---------------------|-----------------|
| ECSS15 | 15' | 17' | 1 | 3" | 1-7/8" | .125 | 170 MPH | 120 MPH | 3' x 5' | 45 lbs. |
| ECSS20 | 20' | 22' | 1 or 3** | 3" | 1-7/8" | .125 | 118 MPH | 85 MPH | 3' x 5' | 54 lbs. |
| ECSS25 | 25' | 27' | 1 or 4** | 3" | 1-7/8" | .125 | 89 MPH | 65 MPH | 4' x 6' | 64 lbs. |
| ECS20 | 20' | 22' | 1 | 3-1/2" | 2-3/8" | .125 | 128 MPH | 96 MPH | 3' x 5' | 61 lbs. |
| ECS25 | 25' | 27' | 1 | 3-1/2" | 2-3/8" | .125 | 95 MPH | 77 MPH | 4' x 6' | 73 lbs. |
| ECS30 | 30' | 33' | 1 or 2* | 4" | 2-3/8" | .125 | 88 MPH | 50 MPH | 5' x 8' | 125 lbs. |
| ECS35 | 35' | 38-1/2' | 1 or 2* | 5" | 3" | .156 | 92 MPH | 76 MPH | 6' x 10' | 213 lbs. |

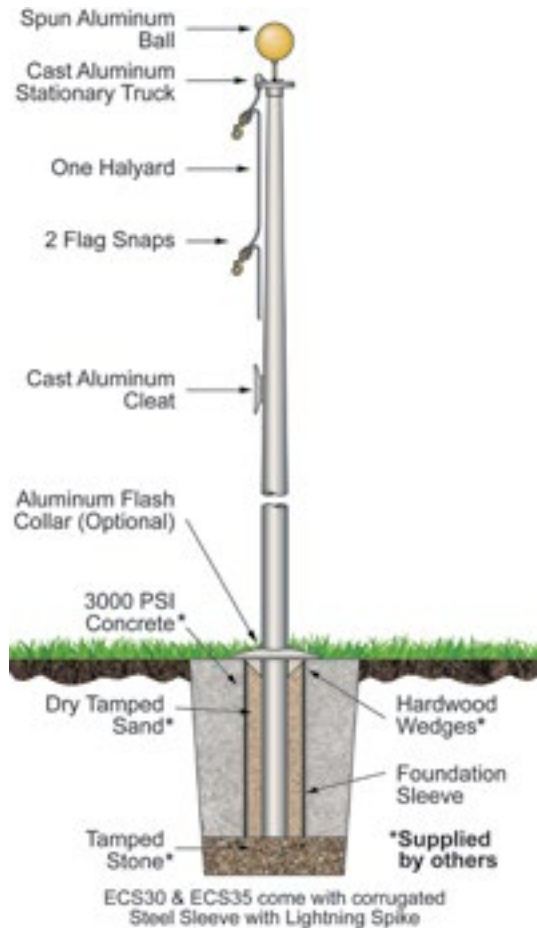

* Flagpole models available in both one and two section styles; please specify when placing your order. Single section pole(s) will be shipped if not specified. **Add 10% to the pricing for two section style flagpoles.**

** Flagpole models also available in multi-piece pole(s); See pricing at bottom.

SATIN

| MODEL | ITEM # | 1-2 | 3-6 | 7+ |
|--------|--------|-------|-------|-------|
| ECSS15 | 320259 | \$700 | \$640 | \$590 |
| ECSS20 | 320260 | 800 | 780 | 750 |
| ECSS25 | 320261 | 940 | 910 | 830 |
| ECS20 | 320262 | 1,160 | 1,100 | 990 |
| ECS25 | 320263 | 1,330 | 1,280 | 1,190 |
| ECS30 | 320264 | 1,460 | 1,390 | 1,300 |
| ECS35 | 320265 | 2,260 | 2,180 | 2,030 |

CLEAR ANODIZED

| MODEL | ITEM # | 1-2 | 3-6 | 7+ |
|--------|--------|-------|-------|-------|
| ECSS15 | 320268 | \$910 | \$840 | \$810 |
| ECSS20 | 320269 | 1,080 | 1,010 | 950 |
| ECSS25 | 320270 | 1,300 | 1,220 | 1,180 |
| ECS20 | 320271 | 1,490 | 1,430 | 1,330 |
| ECS25 | 320272 | 1,730 | 1,650 | 1,510 |
| ECS30 | 320273 | 1,950 | 1,840 | 1,730 |
| ECS35 | 320274 | 2,890 | 2,780 | 2,610 |

BRONZE ANODIZED

| MODEL | ITEM # | 1-2 | 3-6 | 7+ |
|--------|--------|-------|-------|-------|
| ECSS15 | 320277 | \$930 | \$910 | \$840 |
| ECSS20 | 320278 | 1,140 | 1,080 | 1,000 |
| ECSS25 | 320279 | 1,350 | 1,300 | 1,230 |
| ECS20 | 320280 | 1,560 | 1,490 | 1,410 |
| ECS25 | 320281 | 1,770 | 1,670 | 1,580 |
| ECS30 | 320282 | 2,040 | 1,940 | 1,830 |
| ECS35 | 320283 | 3,030 | 2,870 | 2,750 |

BLACK ANODIZED

| MODEL | ITEM # | 1-2 | 3-6 | 7+ |
|--------|--------|-------|-------|-------|
| ECSS15 | 320286 | \$960 | \$930 | \$870 |
| ECSS20 | 320287 | 1,220 | 1,180 | 1,080 |
| ECSS25 | 320288 | 1,430 | 1,380 | 1,300 |
| ECS20 | 320289 | 1,590 | 1,500 | 1,460 |
| ECS25 | 320290 | 1,830 | 1,730 | 1,620 |
| ECS30 | 320291 | 2,170 | 2,070 | 1,950 |
| ECS35 | 320292 | 3,230 | 3,080 | 2,890 |

Add \$60.00 to any of the flagpole pricing above for double-cleat/double-halyard flagpoles. Add \$38.00 for flash collar.

SECTIONAL SPECIAL BUDGET SERIES

External Halyard Ground Set Cone Tapered Aluminum Flagpoles

Looking for an excellent way to reduce your shipping costs on 20 ft. and 25 ft. aluminum flagpoles?

Eder Flag's three section 20 ft. and four section 25 ft. Special Budget Series flagpoles can be shipped via parcel carrier!

These popular poles are:

- Simple to install and come complete in a boxed set with all the standard accessories.
- Easy to store in your warehouse or backroom.
- Available in satin, clear, bronze and black anodized finishes.

This line of commercial grade flagpoles, manufactured using 6063-T6 aluminum tubing, can be used in both residential and commercial applications. These cone tapered flagpoles have the elements of a one piece pole with the advantage of low shipping costs.



**THREE SECTION ECSS20
(CAN BE SHIPPED VIA PARCEL CARRIER)**

| MODEL | ITEM # | FINISH | 1-2 | 3-6 | 7+ | WEIGHT |
|--------|--------|--------|-------|-------|-------|---------|
| SS20TS | 320329 | SATIN | \$940 | \$910 | \$840 | 43 lbs. |
| SS20TS | 320330 | CLEAR | 1,140 | 1,110 | 1,030 | 43 lbs. |
| SS20TS | 320331 | BRONZE | 1,190 | 1,160 | 1,110 | 43 lbs. |
| SS20TS | 320332 | BLACK | 1,270 | 1,220 | 1,160 | 43 lbs. |

**FOUR SECTION ECSS25
(CAN BE SHIPPED VIA PARCEL CARRIER)**

| MODEL | ITEM # | FINISH | 1-2 | 3-6 | 7+ | WEIGHT |
|--------|--------|--------|---------|---------|---------|---------|
| SS25FS | 323976 | SATIN | \$1,120 | \$1,060 | \$1,010 | 52 lbs. |
| SS25FS | 323977 | CLEAR | 1,400 | 1,320 | 1,220 | 52 lbs. |
| SS25FS | 323978 | BRONZE | 1,420 | 1,350 | 1,260 | 52 lbs. |
| SS25FS | 323979 | BLACK | 1,550 | 1,420 | 1,350 | 52 lbs. |



**DELUXE LED SOLAR
FLAGPOLE LIGHT**



See page 144 for more information

Add \$60.00 to any of the flagpole pricing above for double-cleat/double-halyard flagpoles. Add \$38.00 for flash collar.

DELUXE IH SERIES

Internal Halyard Ground Set Cone Tapered Aluminum Flagpoles

These internal halyard flagpoles contain a winch mounted inside the flagpole shaft, operable only with a removable crank handle. As the stainless steel cable unwinds from the winch, it passes up through the inside of the flagpole shaft, over the truck sheave to the outside of the shaft, where the retainer ring provides a sliding anchor. A counterweight, heavily coated with neoprene, attached to the retainer ring, allows the halyard to be lowered for fastening or removing the flag. The winch is gearless and self-locking at any point, eliminating the need for a separate brake. This direct drive winch provides rapid raising and lowering of the flag with little effort. This design does not require any welding, thus avoiding discoloration when an anodized finish is desired. No monthly lubrication is needed.

STANDARD ACCESSORIES

- Cast aluminum revolving truck with enclosed stainless steel bearings and raceway
- Stainless Steel Cable Assembly
- Deluxe Flag Arrangement
- Retainer ring and counterweight
- M-Winch System
- Spun aluminum flash collar
- Galvanized steel foundation sleeve
- See [page 121-122](#) for optional ornament selections

20' – 35' Poles

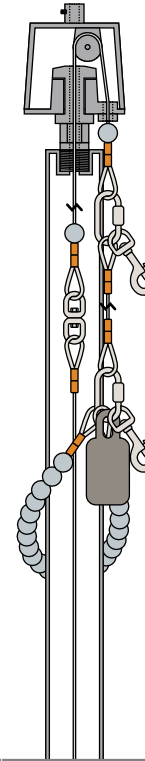

40' – 80' Poles

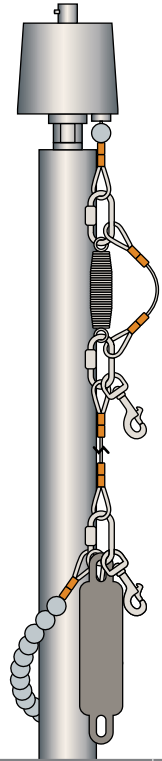

| MODEL | EXPOSED HEIGHT | OVERALL LENGTH | # OF SECTIONS | BUTT DIA. | TOP DIA. | WALL | UNFLAGGED MAX. WIND SPEED | FLAGGED MAX. WIND SPEED | SUGGESTED FLAG SIZE | SHIPPING WEIGHT |
|----------|----------------|----------------|---------------|-----------|----------|------|---------------------------|-------------------------|---------------------|-----------------|
| ECX20IH | 20' | 23' | 1 | 5" | 3" | .125 | 250 MPH | 120+ MPH | 3' x 5' | 129 lbs. |
| EC20IH | 20' | 23' | 1 | 5" | 3" | .188 | 315 MPH | 120+ MPH | 3' x 5' | 147 lbs. |
| ECX25IH | 25' | 27' | 1 | 5" | 3" | .125 | 144 MPH | 104 MPH | 4' x 6' | 139 lbs. |
| ECXA25IH | 25' | 27' | 1 | 5" | 3" | .156 | 192 MPH | 117 MPH | 4' x 6' | 157 lbs. |
| EC25IH | 25' | 27' | 1 | 6" | 3-1/2" | .188 | 222 MPH | 120+ MPH | 4' x 6' | 195 lbs. |
| ECX30IH | 30' | 33' | 1 or 2* | 5" | 3" | .125 | 110 MPH | 75 MPH | 5' x 8' | 177 lbs. |
| ECXA30IH | 30' | 33' | 1 or 2* | 5" | 3" | .156 | 119 MPH | 91 MPH | 5' x 8' | 187 lbs. |
| ECL30IH | 30' | 33' | 1 | 5" | 3" | .188 | 131 MPH | 100 MPH | 5' x 8' | 190 lbs. |
| ECA30IH | 30' | 33' | 1 or 2* | 6" | 3-1/2" | .156 | 184 MPH | 117 MPH | 5' x 8' | 239 lbs. |
| EC30IH | 30' | 33' | 1 or 2* | 6" | 3-1/2" | .188 | 211 MPH | 120+ MPH | 5' x 8' | 242 lbs. |
| ECXA35IH | 35' | 38-1/2' | 1 | 5" | 3" | .188 | 104 MPH | 86 MPH | 6' x 10' | 241 lbs. |
| EC35IH | 35' | 38-1/2' | 1 or 2* | 6" | 3-1/2" | .156 | 122 MPH | 91 MPH | 6' x 10' | 261 lbs. |
| ECA35IH | 35' | 38-1/2' | 1 or 2* | 7" | 3-1/2" | .156 | 179 MPH | 117 MPH | 6' x 10' | 280 lbs. |
| EC35IH | 35' | 38-1/2' | 1 or 2* | 7" | 3-1/2" | .188 | 200 MPH | 120 MPH | 6' x 10' | 290 lbs. |
| ECX40IH | 40' | 44' | 2** | 7" | 3-1/2" | .156 | 125 MPH | 91 MPH | 8' x 12' | 282 lbs. |
| ECA40IH | 40' | 44' | 2** | 8" | 3-1/2" | .156 | 171 MPH | 110 MPH | 8' x 12' | 319 lbs. |
| EC40IH | 40' | 44' | 2** | 8" | 3-1/2" | .188 | 203 MPH | 120 MPH | 8' x 12' | 319 lbs. |
| EC45IH | 45' | 49-1/2' | 2** | 8" | 3-1/2" | .188 | 166 MPH | 100 MPH | 8' x 12' | 371 lbs. |
| ECX50IH | 50' | 55' | 3** | 8" | 3-1/2" | .188 | 118 MPH | 85 MPH | 10' x 15' | 443 lbs. |
| EC50IH | 50' | 55' | 3** | 10" | 4" | .188 | 185 MPH | 115 MPH | 10' x 15' | 523 lbs. |
| ECX60IH | 60' | 66' | 3** | 10" | 4" | .188 | 122 MPH | 90 MPH | 12' x 18' | 675 lbs. |
| ECXA60IH | 60' | 66' | 3** | 10" | 4" | .250 | 150 MPH | 106 MPH | 12' x 18' | 764 lbs. |
| EC60IH | 60' | 66' | 3** | 12" | 4" | .250 | 213 MPH | 120 MPH | 12' x 18' | 843 lbs. |
| ECX70IH | 70' | 77' | 3** | 10" | 4" | .312 | 127 MPH | 91 MPH | 15' x 25' | 1042 lbs. |
| EC70IH | 70' | 77' | 3** | 12" | 4" | .250 | 169 MPH | 105 MPH | 15' x 25' | 988 lbs. |
| EC80IH | 80' | 88' | 3** | 12" | 4" | .375 | 174 MPH | 105 MPH | 20' x 30' | 1367 lbs. |

* Flagpole models available in both one and two section styles; please specify when placing your order. Single section pole(s) will be shipped if not specified. **Add 10% to the pricing for two section style flagpoles.**

** Flagpole models available in multi-piece pole(s) only.

DELUXE IH SERIES

Internal Halyard Ground Set Cone Tapered Aluminum Flagpoles

SATIN

| MODEL | ITEM # | 1-2 | 3-6 | 7+ |
|----------|--------|---------|---------|---------|
| ECX20IH | 320473 | \$3,090 | \$2,930 | \$2,770 |
| EC20IH | 320474 | 3,660 | 3,520 | 3,310 |
| ECX25IH | 320475 | 3,410 | 3,250 | 3,020 |
| ECXA25IH | 320476 | 3,740 | 3,530 | 3,370 |
| EC25IH | 320477 | 5,410 | 5,170 | 4,890 |
| ECX30IH | 320478 | 3,640 | 3,470 | 3,310 |
| ECXA30IH | 320479 | 4,030 | 3,830 | 3,630 |
| ECL30IH | 320892 | 4,280 | 4,080 | 3,900 |
| ECA30IH | 320480 | 6,120 | 5,790 | 5,490 |
| EC30IH | 320481 | 6,290 | 5,990 | 5,680 |
| ECSA35IH | 320482 | 4,440 | 4,220 | 4,000 |
| ECX35IH | 320483 | 6,240 | 5,940 | 5,620 |
| ECA35IH | 320484 | 6,570 | 6,260 | 5,920 |
| EC35IH | 320485 | 7,400 | 7,020 | 6,630 |
| ECX40IH | 320486 | 7,740 | 7,350 | 6,950 |
| ECA40IH | 320487 | 8,840 | 8,390 | 7,940 |
| EC40IH | 320488 | 8,950 | 8,510 | 8,050 |
| EC45IH | 320489 | 9,380 | 8,890 | 8,390 |
| ECX50IH | 320490 | 9,820 | 9,290 | 8,800 |
| EC50IH | 320491 | 11,830 | 11,200 | 10,650 |
| ECX60IH | 320492 | 13,930 | 13,210 | 12,500 |
| ECXA60IH | 320493 | 17,060 | 16,220 | 15,360 |
| EC60IH | 320494 | 21,160 | 20,110 | 19,010 |
| ECX70IH | 320495 | 19,340 | 18,360 | 17,370 |
| EC70IH | 320496 | 23,070 | 21,870 | 20,620 |
| EC80IH | 320497 | 29,820 | 27,950 | 26,520 |

BRONZE ANODIZED

| MODEL | ITEM # | 1-2 | 3-6 | 7+ |
|----------|--------|---------|---------|---------|
| ECX20IH | 320523 | \$3,690 | \$3,530 | \$3,330 |
| EC20IH | 320524 | 4,280 | 4,110 | 3,890 |
| ECX25IH | 320525 | 4,070 | 3,870 | 3,630 |
| ECXA25IH | 320526 | 4,440 | 4,210 | 4,000 |
| EC25IH | 320527 | 6,330 | 5,970 | 5,670 |
| ECX30IH | 320528 | 4,430 | 4,190 | 3,970 |
| ECXA30IH | 320529 | 4,860 | 4,620 | 4,370 |
| ECL30IH | 320894 | 5,040 | 4,770 | 4,550 |
| ECA30IH | 320530 | 7,130 | 6,770 | 6,380 |
| EC30IH | 320531 | 7,330 | 6,960 | 6,620 |
| ECSA35IH | 320532 | 5,330 | 5,040 | 4,820 |
| ECX35IH | 320533 | 7,350 | 7,040 | 6,620 |
| ECA35IH | 320534 | 7,850 | 7,520 | 7,080 |
| EC35IH | 320535 | 8,730 | 8,310 | 7,800 |
| ECX40IH | 320536 | 9,150 | 8,680 | 8,250 |
| ECA40IH | 320537 | 10,440 | 9,930 | 9,370 |
| EC40IH | 320538 | 10,550 | 10,050 | 9,490 |
| EC45IH | 320539 | 11,190 | 10,620 | 10,070 |
| ECX50IH | 320540 | 11,810 | 11,240 | 10,630 |
| EC50IH | 320541 | 14,250 | 13,490 | 12,810 |
| ECX60IH | 320542 | 16,780 | 15,930 | 15,070 |
| ECXA60IH | 320543 | 20,200 | 19,230 | 18,170 |
| EC60IH | 320544 | 24,930 | 23,700 | 22,470 |
| ECX70IH | 320545 | 22,960 | 21,850 | 20,660 |
| EC70IH | 320546 | 27,510 | 26,150 | 24,770 |
| EC80IH | 320547 | 34,980 | 33,220 | 31,260 |

CLEAR ANODIZED

| MODEL | ITEM # | 1-2 | 3-6 | 7+ |
|----------|--------|---------|---------|---------|
| ECX20IH | 320498 | \$3,620 | \$3,500 | \$3,240 |
| EC20IH | 320499 | 4,210 | 4,010 | 3,810 |
| ECX25IH | 320500 | 3,970 | 3,750 | 3,570 |
| ECXA25IH | 320501 | 4,360 | 4,130 | 3,900 |
| EC25IH | 320502 | 6,210 | 5,940 | 5,620 |
| ECX30IH | 320503 | 4,320 | 4,080 | 3,890 |
| ECXA30IH | 320504 | 4,710 | 4,530 | 4,210 |
| ECL30IH | 320893 | 4,910 | 4,700 | 4,390 |
| ECA30IH | 320505 | 7,050 | 6,670 | 6,320 |
| EC30IH | 320506 | 7,270 | 6,890 | 6,490 |
| ECSA35IH | 320507 | 5,280 | 4,990 | 4,750 |
| ECX35IH | 320508 | 7,250 | 6,850 | 6,480 |
| ECA35IH | 320509 | 7,680 | 7,330 | 6,940 |
| EC35IH | 320510 | 8,560 | 8,160 | 7,680 |
| ECX40IH | 320511 | 8,990 | 8,540 | 8,090 |
| ECA40IH | 320512 | 10,230 | 9,740 | 9,200 |
| EC40IH | 320513 | 10,330 | 9,860 | 9,310 |
| EC45IH | 320514 | 10,940 | 10,430 | 9,860 |
| ECX50IH | 320515 | 11,520 | 11,040 | 10,440 |
| EC50IH | 320516 | 13,890 | 13,210 | 12,530 |
| ECX60IH | 320517 | 16,240 | 15,440 | 14,610 |
| ECXA60IH | 320518 | 19,650 | 18,670 | 17,640 |
| EC60IH | 320519 | 24,290 | 23,120 | 21,840 |
| ECX70IH | 320520 | 22,320 | 21,200 | 20,090 |
| EC70IH | 320521 | 26,750 | 25,390 | 24,080 |
| EC80IH | 320522 | 34,060 | 32,360 | 30,660 |

BLACK ANODIZED

| MODEL | ITEM # | 1-2 | 3-6 | 7+ |
|----------|--------|---------|---------|---------|
| ECX20IH | 320548 | \$3,820 | \$3,620 | \$3,440 |
| EC20IH | 320549 | 4,430 | 4,190 | 3,980 |
| ECX25IH | 320550 | 4,200 | 3,990 | 3,750 |
| ECXA25IH | 320551 | 4,560 | 4,360 | 4,110 |
| EC25IH | 320552 | 6,440 | 6,110 | 5,780 |
| ECX30IH | 320553 | 4,590 | 4,370 | 4,120 |
| ECXA30IH | 320554 | 4,990 | 4,760 | 4,500 |
| ECL30IH | 320895 | 5,190 | 4,950 | 4,680 |
| ECA30IH | 320555 | 7,340 | 6,990 | 6,600 |
| EC30IH | 320556 | 7,550 | 7,180 | 6,770 |
| ECSA35IH | 320557 | 5,580 | 5,290 | 4,970 |
| ECX35IH | 320558 | 7,600 | 7,260 | 6,850 |
| ECA35IH | 320559 | 8,130 | 7,680 | 7,280 |
| EC35IH | 320560 | 8,960 | 8,510 | 8,090 |
| ECX40IH | 320561 | 9,460 | 8,990 | 8,510 |
| ECA40IH | 320562 | 10,770 | 10,220 | 9,650 |
| EC40IH | 320563 | 10,890 | 10,320 | 9,770 |
| EC45IH | 320564 | 11,510 | 10,980 | 10,430 |
| ECX50IH | 320565 | 12,200 | 11,550 | 10,950 |
| EC50IH | 320566 | 14,760 | 13,990 | 13,260 |
| ECX60IH | 320567 | 17,230 | 16,370 | 15,540 |
| ECXA60IH | 320568 | 20,630 | 19,610 | 18,550 |
| EC60IH | 320569 | 25,480 | 24,140 | 22,820 |
| ECX70IH | 320570 | 23,430 | 22,290 | 21,050 |
| EC70IH | 320571 | 28,010 | 26,680 | 25,370 |
| EC80IH | 320572 | 35,410 | 33,670 | 31,880 |

M-Winch Detail

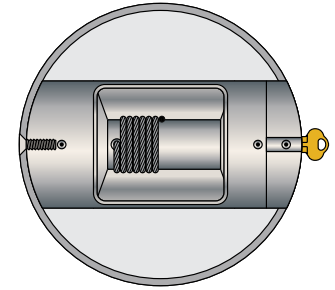

No welding required, thus no discoloration when anodized. No monthly lubrication needed.



HURRICANE SERIES FLAGPOLES - WITH M-WINCH

Internal Halyard Ground Set Cone Tapered Aluminum Flagpoles

These internal halyard flagpoles contain a winch mounted inside the flagpole shaft, operable only with a removable crank handle. As the stainless steel cable unwinds from the winch, it passes up through the inside of the flagpole shaft, over the truck sheave to the outside of the shaft, where the retainer ring provides a sliding anchor. A counterweight, heavily coated with neoprene, attached to the retainer ring, allows the halyard to be lowered for fastening or removing the flag. The winch is gearless and self-locking at any point, eliminating the need for a separate brake. This direct drive winch provides rapid raising and lowering of the flag with little effort. This design does not require any welding, thus avoiding discoloration when an anodized finish is desired. No monthly lubrication is needed.

STANDARD INTERNAL POLE ACCESSORIES

- Cast aluminum revolving truck with enclosed stainless steel bearings and raceway
- Stainless steel cable assembly
- Deluxe flag arrangement
- Retainer ring and counterweight
- M-Winch system
- Spun aluminum flash collar
- Galvanized steel foundation sleeve
- See [page 121-122](#) for optional ornament selections

| MODEL | EXPOSED HEIGHT | OVERALL LENGTH | # OF SECTIONS | BUTT DIA. | TOP DIA. | WALL | UNFLAGGED MAX. WIND SPEED | FLAGGED MAX. WIND SPEED | SUGGESTED FLAG SIZE | SHIPPING WEIGHT |
|---------|----------------|----------------|---------------|-----------|----------|------|---------------------------|-------------------------|---------------------|-----------------|
| ECH25IH | 25' | 27' | 1 | 6" | 3-1/2" | .250 | 255 MPH | 150+ MPH | 4' x 6' | 243 lbs. |
| ECH30IH | 30' | 33' | 2 | 6" | 3-1/2" | .250 | 241 MPH | 150+ MPH | 5' x 8' | 322 lbs. |
| ECH35IH | 35' | 38-1/2' | 2 | 8" | 3-1/2" | .250 | 255 MPH | 150 MPH | 6' x 10' | 361 lbs. |
| ECH40IH | 40' | 44' | 2 | 8" | 3-1/2" | .250 | 231 MPH | 150 MPH | 8' x 12' | 419 lbs. |
| ECH50IH | 50' | 55' | 3 | 10" | 4" | .312 | 230 MPH | 150 MPH | 10' x 15' | 686 lbs. |

M-Winch Detail

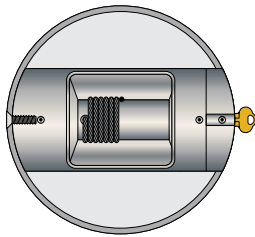

No welding required, thus no discoloration when anodized. No monthly lubrication needed.

20' – 35' Poles

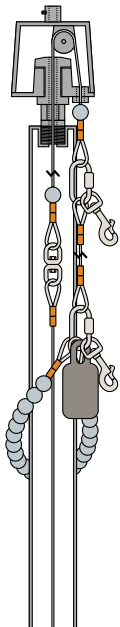

40' – 80' Poles

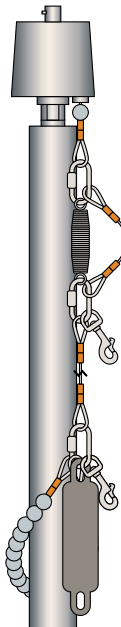

SATIN

| MODEL | ITEM # | 1-2 | 3-6 | 7+ |
|---------|--------|---------|---------|---------|
| ECH25IH | 324137 | \$6,670 | \$6,450 | \$6,230 |
| ECH30IH | 324138 | 8,320 | 8,000 | 7,680 |
| ECH35IH | 324139 | 9,090 | 8,690 | 8,370 |
| ECH40IH | 324140 | 10,370 | 9,950 | 9,550 |
| ECH50IH | 324141 | 16,980 | 16,270 | 15,630 |

CLEAR ANODIZED

| MODEL | ITEM # | 1-2 | 3-6 | 7+ |
|---------|--------|---------|---------|---------|
| ECH25IH | 324142 | \$7,350 | \$7,070 | \$6,770 |
| ECH30IH | 324143 | 9,190 | 8,840 | 8,480 |
| ECH35IH | 324144 | 10,250 | 9,830 | 9,430 |
| ECH40IH | 324145 | 11,730 | 11,260 | 10,820 |
| ECH50IH | 324146 | 19,050 | 18,260 | 17,550 |

BRONZE ANODIZED

| MODEL | ITEM # | 1-2 | 3-6 | 7+ |
|---------|--------|---------|---------|---------|
| ECH25IH | 324147 | \$7,560 | \$7,290 | \$6,950 |
| ECH30IH | 324148 | 9,350 | 8,950 | 8,630 |
| ECH35IH | 324149 | 10,520 | 10,130 | 9,690 |
| ECH40IH | 324150 | 12,060 | 11,550 | 11,130 |
| ECH50IH | 324151 | 19,540 | 18,780 | 17,990 |

BLACK ANODIZED

| MODEL | ITEM # | 1-2 | 3-6 | 7+ |
|---------|--------|---------|---------|---------|
| ECH25IH | 324152 | \$7,800 | \$7,520 | \$7,190 |
| ECH30IH | 324153 | 9,660 | 9,280 | 8,890 |
| ECH35IH | 324154 | 10,950 | 10,530 | 10,130 |
| ECH40IH | 324155 | 12,570 | 12,080 | 11,540 |
| ECH50IH | 324156 | 20,230 | 19,450 | 18,670 |

VANGUARD SERIES

Internal Halyard Ground Set Cone Tapered Aluminum Flagpoles

The Vanguard series provides an intelligent, economical alternative to deluxe concealed halyard systems.

STANDARD ACCESSORIES

- Gold anodized aluminum ball ornament
- Cast aluminum revolving truck on all flagpole models
- Nylon wire center halyard
- Swivel flag snaps w/vinyl snap covers
- Retainer ring and counterweight
- Stainless steel quick link
- Cam action cleat (accessible behind a lockable access door)
- Spun aluminum flash collar
- Galvanized steel foundation sleeve

| MODEL | EXPOSED HEIGHT | OVERALL LENGTH | # OF SECTIONS | BUTT DIA. | TOP DIA. | WALL | UNFLAGGED MAX. WIND SPEED | FLAGGED MAX. WIND SPEED | SUGGESTED FLAG SIZE | SHIPPING WEIGHT |
|---------|----------------|----------------|---------------|-----------|----------|------|---------------------------|-------------------------|---------------------|-----------------|
| ECXV20 | 20' | 23' | 1 | 5" | 3" | .125 | 250 MPH | 120+ MPH | 3' x 5' | 129 lbs. |
| ECV20 | 20' | 23' | 1 | 5" | 3" | .188 | 315 MPH | 120+ MPH | 3' x 5' | 142 lbs. |
| ECXV25 | 25' | 27' | 1 | 5" | 3" | .125 | 144 MPH | 104 MPH | 4' x 6' | 139 lbs. |
| ECXAV25 | 25' | 27' | 1 | 5" | 3" | .156 | 192 MPH | 117 MPH | 4' x 6' | 152 lbs. |
| ECV25 | 25' | 27' | 1 | 6" | 3-1/2" | .188 | 222 MPH | 120+ MPH | 4' x 6' | 197 lbs. |
| ECXAV30 | 30' | 33' | 1 or 2* | 5" | 3" | .156 | 119 MPH | 91 MPH | 5' x 8' | 185 lbs. |
| ECLV30 | 30' | 33' | 1 | 5" | 3" | .188 | 127 MPH | 96 MPH | 5' x 8' | 185 lbs. |
| ECAV30 | 30' | 33' | 1 | 6" | 3-1/2" | .156 | 184 MPH | 117 MPH | 5' x 8' | 224 lbs. |
| ECV30 | 30' | 33' | 1 | 6" | 3-1/2" | .188 | 211 MPH | 120+ MPH | 5' x 8' | 227 lbs. |
| ECXV35 | 35' | 38-1/2' | 1 | 6" | 3-1/2" | .156 | 122 MPH | 91 MPH | 6' x 10' | 247 lbs. |
| ECAV35 | 35' | 38-1/2' | 1 | 7" | 3-1/2" | .156 | 179 MPH | 117 MPH | 6' x 10' | 261 lbs. |
| ECV35 | 35' | 38-1/2' | 1 | 7" | 3-1/2" | .188 | 200 MPH | 120 MPH | 6' x 10' | 281 lbs. |
| ECXV40 | 40' | 44' | 2** | 7" | 3-1/2" | .156 | 125 MPH | 91 MPH | 8' x 12' | 294 lbs. |
| ECV40 | 40' | 44' | 2** | 8" | 3-1/2" | .188 | 195 MPH | 120 MPH | 8' x 12' | 319 lbs. |

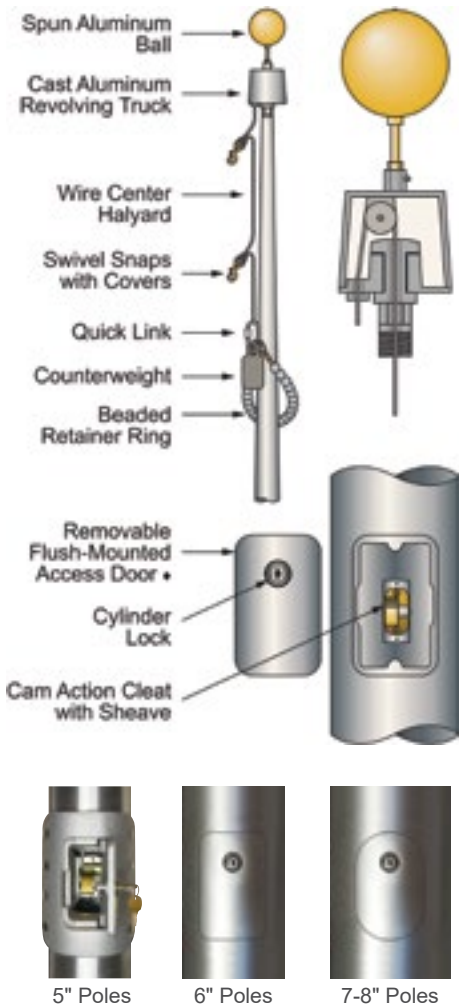

* Flagpole models available in both one and two section styles; please specify when placing your order. Single section pole(s) will be shipped if not specified. **Add 10% to the pricing for two section style flagpoles.**

** Flagpole models available in multi-piece pole(s) only.

SATIN

| MODEL | ITEM # | 1-2 | 3-6 | 7+ |
|---------|--------|---------|---------|---------|
| ECXV20 | 320409 | \$2,470 | \$2,260 | \$2,190 |
| ECV20 | 320410 | 2,960 | 2,830 | 2,670 |
| ECXV25 | 320411 | 2,730 | 2,580 | 2,470 |
| ECXAV25 | 320412 | 3,040 | 2,900 | 2,740 |
| ECV25 | 320413 | 4,010 | 3,810 | 3,620 |
| ECXAV30 | 320415 | 3,380 | 3,180 | 3,020 |
| ECLV30 | 320888 | 3,540 | 3,380 | 3,240 |
| ECAV30 | 320416 | 3,910 | 3,690 | 3,520 |
| ECV30 | 320417 | 4,130 | 3,960 | 3,730 |
| ECXV35 | 320419 | 4,130 | 3,960 | 3,730 |
| ECAV35 | 320420 | 4,670 | 4,410 | 4,210 |
| ECV35 | 320421 | 5,350 | 5,040 | 4,780 |
| ECXV40 | 320422 | 5,760 | 5,510 | 5,170 |
| ECV40 | 320424 | 7,100 | 6,680 | 6,370 |

CLEAR ANODIZED

| MODEL | ITEM # | 1-2 | 3-6 | 7+ |
|---------|--------|---------|---------|---------|
| ECXV20 | 320425 | \$2,900 | \$2,790 | \$2,680 |
| ECV20 | 320426 | 3,540 | 3,340 | 3,190 |
| ECXV25 | 320427 | 3,240 | 3,090 | 2,910 |
| ECXAV25 | 320428 | 3,660 | 3,520 | 3,320 |
| ECV25 | 320429 | 4,600 | 4,360 | 4,120 |
| ECXAV30 | 320431 | 4,030 | 3,800 | 3,630 |
| ECLV30 | 320889 | 4,150 | 3,910 | 3,760 |
| ECAV30 | 320432 | 4,730 | 4,480 | 4,210 |
| ECV30 | 320433 | 4,970 | 4,710 | 4,460 |
| ECXV35 | 320435 | 5,040 | 4,790 | 4,570 |
| ECAV35 | 320436 | 5,640 | 5,370 | 5,030 |
| ECV35 | 320437 | 6,320 | 5,960 | 5,660 |
| ECXV40 | 320438 | 6,890 | 6,560 | 6,220 |
| ECV40 | 320440 | 8,440 | 7,990 | 7,590 |

BRONZE ANODIZED

| MODEL | ITEM # | 1-2 | 3-6 | 7+ |
|---------|--------|---------|---------|---------|
| ECXV20 | 320441 | \$3,010 | \$2,880 | \$2,720 |
| ECV20 | 320442 | 3,630 | 3,430 | 3,220 |
| ECXV25 | 320443 | 3,400 | 3,180 | 3,030 |
| ECXAV25 | 320444 | 3,750 | 3,590 | 3,400 |
| ECV25 | 320445 | 4,650 | 4,440 | 4,180 |
| ECXAV30 | 320447 | 4,150 | 3,970 | 3,730 |
| ECLV30 | 320890 | 4,220 | 4,040 | 3,900 |
| ECAV30 | 320448 | 4,770 | 4,530 | 4,310 |
| ECV30 | 320449 | 5,040 | 4,790 | 4,570 |
| ECXV35 | 320451 | 5,170 | 4,900 | 4,650 |
| ECAV35 | 320452 | 5,820 | 5,500 | 5,200 |
| ECV35 | 320453 | 6,510 | 6,180 | 5,870 |
| ECXV40 | 320454 | 7,090 | 6,720 | 6,380 |
| ECV40 | 320456 | 8,600 | 8,190 | 7,720 |

BLACK ANODIZED

| MODEL | ITEM # | 1-2 | 3-6 | 7+ |
|---------|--------|---------|---------|---------|
| ECXV20 | 320457 | \$3,090 | \$2,910 | \$2,790 |
| ECV20 | 320458 | 3,730 | 3,520 | 3,280 |
| ECXV25 | 320459 | 3,540 | 3,350 | 3,100 |
| ECXAV25 | 320460 | 3,910 | 3,700 | 3,530 |
| ECV25 | 320461 | 4,850 | 4,600 | 4,350 |
| ECXAV30 | 320463 | 4,310 | 4,080 | 3,870 |
| ECLV30 | 320891 | 4,390 | 4,200 | 4,030 |
| ECAV30 | 320464 | 5,010 | 4,760 | 4,530 |
| ECV30 | 320465 | 5,290 | 5,020 | 4,770 |
| ECXV35 | 320467 | 5,460 | 5,150 | 4,870 |
| ECAV35 | 320468 | 6,070 | 5,760 | 5,480 |
| ECV35 | 320469 | 6,770 | 6,460 | 6,070 |
| ECXV40 | 320470 | 7,380 | 6,990 | 6,620 |
| ECV40 | 320472 | 8,890 | 8,480 | 8,030 |

♦ 5" diameter poles supplied with a hinged access door and frame unit. 6" and larger diameter poles supplied with a removable flush-mounted access door for added strength.

SINGLE MAST NAUTICAL SERIES WITH YARDARM

External Halyard Ground Set Cone Tapered Aluminum Flagpoles



STANDARD ACCESSORIES

- Gold anodized aluminum ball ornament
- Cast aluminum revolving truck w/pulley
- Aluminum yardarm with pulleys & mounting hardware
- 3 lengths of solid braided polyester halyard
- Swivel flag snaps w/vinyl snap covers
- 3 cast aluminum cleats with mounting screws
- Spun aluminum flash collar
- Galvanized steel foundation sleeve



| MODEL | EXPOSED HEIGHT | OVERALL LENGTH | # OF SECTIONS | BUTT DIA. | TOP DIA. | WALL | YARDARM LENGTH [♦] | SHIPPING WEIGHT |
|-----------|----------------|----------------|---------------|-----------|----------|------|-----------------------------|-----------------|
| ECXP20-Y | 20' | 23' | 1 | 5" | 3" | .125 | 6' | 155 lbs. |
| ECP20-Y | 20' | 23' | 1 | 5" | 3" | .188 | 6' | 173 lbs. |
| ECXP25-Y | 25' | 27' | 1 | 5" | 3" | .125 | 6-1/2' | 167 lbs. |
| ECXAP25-Y | 25' | 27' | 1 | 5" | 3" | .156 | 6-1/2' | 185 lbs. |
| ECP25-Y | 25' | 27' | 1 | 6" | 3-1/2" | .188 | 6-1/2' | 233 lbs. |
| ECXP30-Y | 30' | 33' | 1 or 2* | 5" | 3" | .125 | 8-1/2' | 194 lbs. |
| ECXAP30-Y | 30' | 33' | 1 or 2* | 5" | 3" | .156 | 8-1/2' | 202 lbs. |
| ECAP30-Y | 30' | 33' | 1 or 2* | 6" | 3-1/2" | .156 | 8-1/2' | 254 lbs. |
| ECP30-Y | 30' | 33' | 1 or 2* | 6" | 3-1/2" | .188 | 8-1/2' | 257 lbs. |
| ECSAP35-Y | 35' | 38-1/2' | 1 | 5" | 3" | .188 | 9-1/2' | 262 lbs. |
| ECXP35-Y | 35' | 38-1/2' | 1 or 2* | 6" | 3-1/2" | .156 | 9-1/2' | 280 lbs. |
| ECAP35-Y | 35' | 38-1/2' | 1 or 2* | 7" | 3-1/2" | .156 | 9-1/2' | 299 lbs. |
| ECP35-Y | 35' | 38-1/2' | 1 or 2* | 7" | 3-1/2" | .188 | 9-1/2' | 319 lbs. |
| ECXP40-Y | 40' | 44' | 2** | 7" | 3-1/2" | .156 | 11' | 324 lbs. |
| ECP40-Y | 40' | 44' | 2** | 8" | 3-1/2" | .188 | 11' | 361 lbs. |
| ECP45-Y | 45' | 49-1/2' | 2** | 8" | 3-1/2" | .188 | 11' | 413 lbs. |

♦ Yardarm Center diameter is 3-1/2", End diameter is 2"

* Flagpole models available in both one and two section styles; please specify when placing your order. Single section pole(s) will be shipped if not specified.

Add 10% to the pricing for two section style flagpoles.

** Flagpole models available in multi-piece pole(s) only.

YARDARM ASSEMBLY DETAIL

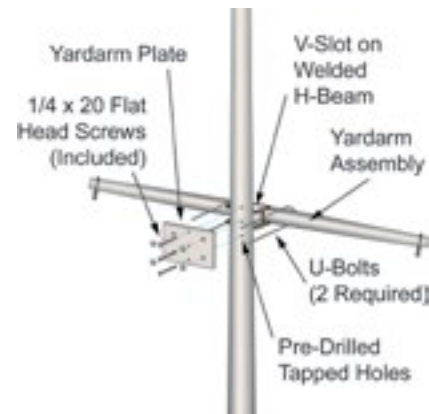

SINGLE MAST NAUTICAL SERIES WITH YARDARM

External Halyard Ground Set Cone Tapered Aluminum Flagpoles

NOTE: All pole pricing below includes the yardarm. See [page 114](#) for pricing on yardarms only.

SATIN

| MODEL | ITEM # | 1-2 | 3-6 | 7+ |
|-----------|--------|---------|---------|---------|
| ECXP20-Y | 320573 | \$3,160 | \$2,980 | \$2,810 |
| ECP20-Y | 320574 | 3,740 | 3,550 | 3,370 |
| ECXP25-Y | 320575 | 3,360 | 3,160 | 2,950 |
| ECXAP25-Y | 320576 | 3,740 | 3,520 | 3,340 |
| ECP25-Y | 320577 | 4,420 | 4,210 | 3,960 |
| ECXP30-Y | 320578 | 3,680 | 3,530 | 3,310 |
| ECXAP30-Y | 320579 | 4,130 | 3,920 | 3,670 |
| ECAP30-Y | 320580 | 4,730 | 4,550 | 4,220 |
| ECP30-Y | 320581 | 4,850 | 4,620 | 4,310 |
| ECSAP35-Y | 320582 | 4,470 | 4,270 | 4,000 |
| ECXP35-Y | 320583 | 4,890 | 4,670 | 4,320 |
| ECAP35-Y | 320584 | 5,400 | 5,130 | 4,830 |
| ECP35-Y | 320585 | 6,000 | 5,710 | 5,400 |
| ECXP40-Y | 320586 | 6,670 | 6,370 | 6,000 |
| ECP40-Y | 320588 | 7,500 | 7,190 | 6,810 |
| ECP45-Y | 320589 | 8,230 | 7,840 | 7,410 |

CLEAR ANODIZED

| MODEL | ITEM # | 1-2 | 3-6 | 7+ |
|-----------|--------|---------|---------|---------|
| ECXP20-Y | 320598 | \$3,920 | \$3,710 | \$3,540 |
| ECP20-Y | 320599 | 4,560 | 4,360 | 4,120 |
| ECXP25-Y | 320600 | 4,160 | 3,990 | 3,700 |
| ECXAP25-Y | 320601 | 4,500 | 4,320 | 4,070 |
| ECP25-Y | 320602 | 5,410 | 5,100 | 4,840 |
| ECXP30-Y | 320603 | 4,670 | 4,430 | 4,220 |
| ECXAP30-Y | 320604 | 5,060 | 4,810 | 4,500 |
| ECAP30-Y | 320605 | 5,800 | 5,550 | 5,210 |
| ECP30-Y | 320606 | 5,940 | 5,660 | 5,320 |
| ECSAP35-Y | 320607 | 5,590 | 5,290 | 4,970 |
| ECXP35-Y | 320608 | 6,110 | 5,760 | 5,480 |
| ECAP35-Y | 320609 | 6,720 | 6,350 | 5,950 |
| ECP35-Y | 320610 | 7,380 | 7,050 | 6,620 |
| ECXP40-Y | 320611 | 8,140 | 7,790 | 7,320 |
| ECP40-Y | 320613 | 9,210 | 8,760 | 8,250 |
| ECP45-Y | 320614 | 10,010 | 9,470 | 8,960 |

BRONZE ANODIZED

| MODEL | ITEM # | 1-2 | 3-6 | 7+ |
|-----------|--------|---------|---------|---------|
| ECXP20-Y | 320623 | \$4,010 | \$3,810 | \$3,620 |
| ECP20-Y | 320624 | 4,660 | 4,440 | 4,190 |
| ECXP25-Y | 320625 | 4,280 | 4,110 | 3,830 |
| ECXAP25-Y | 320626 | 4,760 | 4,460 | 4,270 |
| ECP25-Y | 320627 | 5,510 | 5,300 | 4,970 |
| ECXP30-Y | 320628 | 4,810 | 4,620 | 4,310 |
| ECXAP30-Y | 320629 | 5,310 | 5,060 | 4,790 |
| ECAP30-Y | 320630 | 6,070 | 5,760 | 5,480 |
| ECP30-Y | 320631 | 6,210 | 5,880 | 5,570 |
| ECSAP35-Y | 320632 | 5,800 | 5,510 | 5,230 |
| ECXP35-Y | 320633 | 6,390 | 6,070 | 5,670 |
| ECAP35-Y | 320634 | 7,000 | 6,670 | 6,310 |
| ECP35-Y | 320635 | 7,720 | 7,320 | 6,910 |
| ECXP40-Y | 320636 | 8,580 | 8,160 | 7,710 |
| ECP40-Y | 320638 | 9,620 | 9,150 | 8,650 |
| ECP45-Y | 320639 | 10,450 | 9,900 | 9,380 |

BLACK ANODIZED

| MODEL | ITEM # | 1-2 | 3-6 | 7+ |
|-----------|--------|---------|---------|---------|
| ECXP20-Y | 320648 | \$4,210 | \$4,010 | \$3,750 |
| ECP20-Y | 320649 | 4,870 | 4,660 | 4,380 |
| ECXP25-Y | 320650 | 4,560 | 4,290 | 4,030 |
| ECXAP25-Y | 320651 | 4,920 | 4,670 | 4,380 |
| ECP25-Y | 320652 | 5,880 | 5,570 | 5,270 |
| ECXP30-Y | 320653 | 5,150 | 4,910 | 4,620 |
| ECXAP30-Y | 320654 | 5,550 | 5,270 | 4,950 |
| ECAP30-Y | 320655 | 6,350 | 6,040 | 5,660 |
| ECP30-Y | 320656 | 6,570 | 6,240 | 5,880 |
| ECSAP35-Y | 320657 | 6,110 | 5,790 | 5,490 |
| ECXP35-Y | 320658 | 6,720 | 6,410 | 5,960 |
| ECAP35-Y | 320659 | 7,340 | 7,000 | 6,620 |
| ECP35-Y | 320660 | 8,090 | 7,650 | 7,250 |
| ECXP40-Y | 320661 | 8,960 | 8,550 | 8,030 |
| ECP40-Y | 320663 | 10,140 | 9,620 | 9,120 |
| ECP45-Y | 320664 | 11,010 | 10,470 | 9,890 |

SINGLE MAST NAUTICAL SERIES WITH YARDARM & GAFF

External Halyard Ground Set Cone Tapered Aluminum Flagpoles



YARDARM & GAFF ASSEMBLY DETAIL



STANDARD ACCESSORIES

- Gold anodized aluminum ball ornament
- Cast aluminum revolving truck w/pulley
- Aluminum yardarm & gaff with pulleys & mounting hardware
- 4 lengths of solid braided polyester halyard
- Swivel flag snaps w/vinyl snap covers
- 4 cast aluminum cleats with mounting screws
- Spun aluminum flash collar
- Galvanized steel foundation sleeve

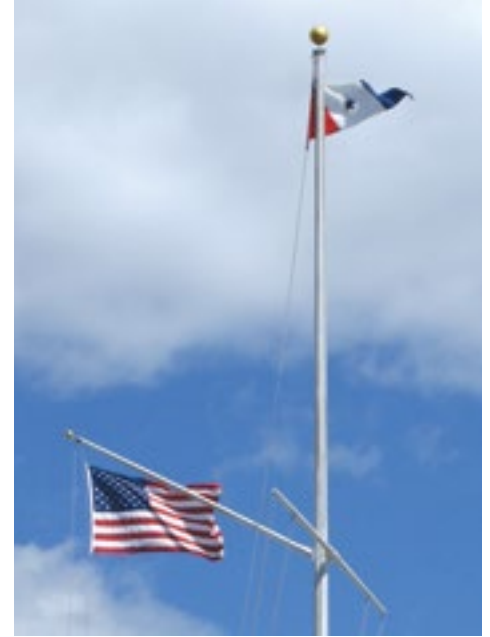

| MODEL | EXP. HEIGHT | OVERALL LENGTH | # OF SECTIONS | BUTT DIA. | TOP DIA. | WALL | YARDARM LENGTH [♦] | GAFF [■] LENGTH | SHIPPING WEIGHT |
|------------|-------------|----------------|---------------|-----------|----------|------|-----------------------------|--------------------------|-----------------|
| ECXP20-YG | 20' | 23' | 1 | 5" | 3" | .125 | 6' | 5' | 185 lbs. |
| ECP20-YG | 20' | 23' | 1 | 5" | 3" | .188 | 6' | 5' | 203 lbs. |
| ECXP25-YG | 25' | 27' | 1 | 5" | 3" | .125 | 6-1/2' | 5-1/2' | 217 lbs. |
| ECXAP25-YG | 25' | 27' | 1 | 5" | 3" | .156 | 6-1/2' | 5-1/2' | 217 lbs. |
| ECP25-YG | 25' | 27' | 1 | 6" | 3-1/2" | .188 | 6-1/2' | 5-1/2' | 263 lbs. |
| ECXP30-YG | 30' | 33' | 1 or 2* | 5" | 3" | .125 | 8-1/2' | 6-1/2' | 227 lbs. |
| ECXAP30-YG | 30' | 33' | 1 or 2* | 5" | 3" | .156 | 8-1/2' | 6-1/2' | 235 lbs. |
| ECAP30-YG | 30' | 33' | 1 or 2* | 6" | 3-1/2" | .156 | 8-1/2' | 6-1/2' | 279 lbs. |
| ECP30-YG | 30' | 33' | 1 or 2* | 6" | 3-1/2" | .188 | 8-1/2' | 6-1/2' | 290 lbs. |
| ECSAP35-YG | 35' | 38-1/2' | 1 | 5" | 3" | .188 | 9-1/2' | 7-1/2' | 289 lbs. |
| ECXP35-YG | 35' | 38-1/2' | 1 or 2* | 6" | 3-1/2" | .156 | 9-1/2' | 7-1/2' | 307 lbs. |
| ECAP35-YG | 35' | 38-1/2' | 1 or 2* | 7" | 3-1/2" | .156 | 9-1/2' | 7-1/2' | 336 lbs. |
| ECP35-YG | 35' | 38-1/2' | 1 or 2* | 7" | 3-1/2" | .188 | 9-1/2' | 7-1/2' | 356 lbs. |
| ECXP40-YG | 40' | 44' | 2** | 7" | 3-1/2" | .156 | 11' | 9' | 366 lbs. |
| ECP40-YG | 40' | 44' | 2** | 8" | 3-1/2" | .188 | 11' | 9' | 403 lbs. |
| ECP45-YG | 45' | 49-1/2' | 2** | 8" | 3-1/2" | .188 | 11' | 9' | 455 lbs. |

♦ Yardarm Center diameter is 3-1/2", End diameter is 2" | ■ Gaff Butt diameter is 3-1/2", Top diameter is 2"

* Flagpole models available in both one and two section styles; please specify when placing your order. Single section pole(s) will be shipped if not specified.
Add 10% to the pricing for two section style flagpoles.

** Flagpole models available in multi-piece pole(s) only.

SINGLE MAST NAUTICAL SERIES WITH YARDARM & GAFF

External Halyard Ground Set Cone Tapered Aluminum Flagpoles

NOTE: All pole pricing below includes the yardarm & gaff. See [page 114](#) for pricing on yardarms & gaffs only.

SATIN

| MODEL | ITEM # | 1-2 | 3-6 | 7+ |
|------------|--------|---------|---------|---------|
| ECXP20-YG | 320673 | \$4,040 | \$3,820 | \$3,570 |
| ECP20-YG | 320674 | 4,660 | 4,420 | 4,140 |
| ECXP25-YG | 320675 | 4,270 | 4,040 | 3,760 |
| ECXAP25-YG | 320676 | 4,670 | 4,410 | 4,130 |
| ECP25-YG | 320677 | 5,380 | 5,130 | 4,850 |
| ECXP30-YG | 320678 | 4,720 | 4,500 | 4,190 |
| ECXAP30-YG | 320679 | 5,180 | 4,870 | 4,590 |
| ECAP30-YG | 320680 | 5,740 | 5,490 | 5,130 |
| ECP30-YG | 320681 | 5,840 | 5,580 | 5,220 |
| ECSAP35-YG | 320682 | 5,510 | 5,260 | 4,890 |
| ECXP35-YG | 320683 | 5,950 | 5,670 | 5,250 |
| ECAP35-YG | 320684 | 6,420 | 6,140 | 5,740 |
| ECP35-YG | 320685 | 7,110 | 6,760 | 6,310 |
| ECXP40-YG | 320686 | 7,770 | 7,420 | 6,990 |
| ECP40-YG | 320688 | 8,590 | 8,280 | 7,740 |
| ECP45-YG | 320689 | 9,320 | 8,890 | 8,370 |

CLEAR ANODIZED

| MODEL | ITEM # | 1-2 | 3-6 | 7+ |
|------------|--------|---------|---------|---------|
| ECXP20-YG | 320698 | \$5,020 | \$4,790 | \$4,500 |
| ECP20-YG | 320699 | 5,750 | 5,480 | 5,130 |
| ECXP25-YG | 320700 | 5,360 | 5,130 | 4,790 |
| ECXAP25-YG | 320701 | 5,730 | 5,500 | 5,130 |
| ECP25-YG | 320702 | 6,680 | 6,320 | 5,960 |
| ECXP30-YG | 320703 | 5,940 | 5,660 | 5,400 |
| ECXAP30-YG | 320704 | 6,380 | 6,040 | 5,670 |
| ECAP30-YG | 320705 | 7,130 | 6,760 | 6,380 |
| ECP30-YG | 320706 | 7,280 | 6,910 | 6,490 |
| ECSAP35-YG | 320707 | 6,940 | 6,570 | 6,210 |
| ECXP35-YG | 320708 | 7,440 | 7,080 | 6,680 |
| ECAP35-YG | 320709 | 8,070 | 7,640 | 7,250 |
| ECP35-YG | 320710 | 8,740 | 8,360 | 7,830 |
| ECXP40-YG | 320711 | 9,620 | 9,150 | 8,620 |
| ECP40-YG | 320713 | 10,680 | 10,130 | 9,560 |
| ECP45-YG | 320714 | 11,460 | 10,880 | 10,260 |

BRONZE ANODIZED

| MODEL | ITEM # | 1-2 | 3-6 | 7+ |
|------------|--------|---------|---------|---------|
| ECXP20-YG | 320723 | \$5,200 | \$4,960 | \$4,700 |
| ECP20-YG | 320724 | 5,890 | 5,610 | 5,300 |
| ECXP25-YG | 320725 | 5,590 | 5,310 | 5,000 |
| ECXAP25-YG | 320726 | 6,060 | 5,690 | 5,410 |
| ECP25-YG | 320727 | 6,870 | 6,570 | 6,150 |
| ECXP30-YG | 320728 | 6,150 | 5,900 | 5,570 |
| ECXAP30-YG | 320729 | 6,680 | 6,380 | 5,970 |
| ECAP30-YG | 320730 | 7,420 | 7,080 | 6,680 |
| ECP30-YG | 320731 | 7,550 | 7,180 | 6,770 |
| ECSAP35-YG | 320732 | 7,340 | 6,970 | 6,570 |
| ECXP35-YG | 320733 | 7,890 | 7,530 | 7,070 |
| ECAP35-YG | 320734 | 8,510 | 8,140 | 7,640 |
| ECP35-YG | 320735 | 9,280 | 8,780 | 8,280 |
| ECXP40-YG | 320736 | 10,290 | 9,800 | 9,210 |
| ECP40-YG | 320738 | 11,340 | 10,790 | 10,130 |
| ECP45-YG | 320739 | 12,180 | 11,520 | 10,890 |

BLACK ANODIZED

| MODEL | ITEM # | 1-2 | 3-6 | 7+ |
|------------|--------|---------|---------|---------|
| ECXP20-YG | 320748 | \$5,490 | \$5,200 | \$4,910 |
| ECP20-YG | 320749 | 6,180 | 5,890 | 5,550 |
| ECXP25-YG | 320750 | 5,900 | 5,600 | 5,270 |
| ECXAP25-YG | 320751 | 6,260 | 5,930 | 5,610 |
| ECP25-YG | 320752 | 7,290 | 6,910 | 6,510 |
| ECXP30-YG | 320753 | 6,620 | 6,310 | 5,900 |
| ECXAP30-YG | 320754 | 7,000 | 6,620 | 6,250 |
| ECAP30-YG | 320755 | 7,800 | 7,420 | 6,970 |
| ECP30-YG | 320756 | 8,070 | 7,590 | 7,180 |
| ECSAP35-YG | 320757 | 7,770 | 7,420 | 6,960 |
| ECXP35-YG | 320758 | 8,390 | 8,020 | 7,520 |
| ECAP35-YG | 320759 | 9,040 | 8,620 | 8,130 |
| ECP35-YG | 320760 | 9,750 | 9,300 | 8,730 |
| ECXP40-YG | 320761 | 10,860 | 10,290 | 9,690 |
| ECP40-YG | 320763 | 11,990 | 11,380 | 10,770 |
| ECP45-YG | 320764 | 12,840 | 12,220 | 11,520 |

OUTDOOR FLAGPOLES | Nautical Yardarms & Gaffs

ALUMINUM YARDARMS

Cone Tapered For Single Mast Nautical Poles



Each yardarm is supplied with end pulleys, (2) lengths of solid braided polyester halyard with swivel flag snaps & snap covers, (2) 9" cast aluminum cleats with mounting screws plus all mounting hardware for a standard installation.

| MODEL | FOR POLE HEIGHT | OVERALL LENGTH | CENTER DIA. | DIA. AT ENDS | SHIPPING WEIGHT |
|-------|-----------------|----------------|-------------|--------------|-----------------|
| Y60 | 20' | 6' | 3-1/2" | 2" | 31 lbs. |
| Y65 | 25' | 6-1/2' | 3-1/2" | 2" | 33 lbs. |
| Y85 | 30' | 8-1/2' | 3-1/2" | 2" | 40 lbs. |
| Y95 | 35' | 9-1/2' | 3-1/2" | 2" | 43 lbs. |
| Y110 | 40'/45' | 11' | 3-1/2" | 2" | 52 lbs. |

SATIN

| MODEL | ITEM # | 1-2 | 3-6 | 7+ |
|-------|--------|---------|---------|---------|
| Y60 | 320773 | \$1,300 | \$1,210 | \$1,150 |
| Y65 | 320774 | 1,360 | 1,300 | 1,190 |
| Y85 | 320775 | 1,460 | 1,390 | 1,300 |
| Y95 | 320776 | 1,470 | 1,430 | 1,330 |
| Y110 | 320777 | 1,620 | 1,550 | 1,460 |

CLEAR ANODIZED

| MODEL | ITEM # | 1-2 | 3-6 | 7+ |
|-------|--------|---------|---------|---------|
| Y60 | 320782 | \$1,580 | \$1,490 | \$1,420 |
| Y65 | 320783 | 1,650 | 1,580 | 1,470 |
| Y85 | 320784 | 1,840 | 1,700 | 1,620 |
| Y95 | 320785 | 1,930 | 1,770 | 1,650 |
| Y110 | 320786 | 2,070 | 1,980 | 1,880 |

BRONZE ANODIZED

| MODEL | ITEM # | 1-2 | 3-6 | 7+ |
|-------|--------|---------|---------|---------|
| Y60 | 320791 | \$1,590 | \$1,510 | \$1,460 |
| Y65 | 320792 | 1,700 | 1,640 | 1,550 |
| Y85 | 320793 | 1,960 | 1,880 | 1,730 |
| Y95 | 320794 | 2,060 | 1,960 | 1,840 |
| Y110 | 320795 | 2,290 | 2,170 | 2,040 |

BLACK ANODIZED

| MODEL | ITEM # | 1-2 | 3-6 | 7+ |
|-------|--------|---------|---------|---------|
| Y60 | 320800 | \$1,670 | \$1,620 | \$1,510 |
| Y65 | 320801 | 1,840 | 1,700 | 1,620 |
| Y85 | 320802 | 2,060 | 1,960 | 1,840 |
| Y95 | 320803 | 2,130 | 2,040 | 1,940 |
| Y110 | 320804 | 2,400 | 2,290 | 2,150 |

ALUMINUM GAFFS

Cone Tapered For Single Mast Nautical Poles



Each gaff is supplied with an end pulley, (1) length of solid braided polyester halyard with swivel flag snaps & snap covers, (1) 9" cast aluminum cleat with mounting screws plus all mounting hardware for a standard installation.

| MODEL | FOR POLE HEIGHT | OVERALL LENGTH | CENTER DIA. | DIA. AT ENDS | SHIPPING WEIGHT |
|-------|-----------------|----------------|-------------|--------------|-----------------|
| G50 | 20' | 5' | 3-1/2" | 2" | 30 lbs. |
| G56 | 25' | 5-1/2' | 3-1/2" | 2" | 30 lbs. |
| G66 | 30' | 6-1/2' | 3-1/2" | 2" | 33 lbs. |
| G76 | 35' | 7-1/2' | 3-1/2" | 2-3/8" | 37 lbs. |
| G90 | 40'/45' | 9' | 3-1/2" | 2-3/8" | 42 lbs. |

SATIN

| MODEL | ITEM # | 1-2 | 3-6 | 7+ |
|-------|--------|-------|-------|-------|
| G50 | 320809 | \$850 | \$820 | \$790 |
| G56 | 320810 | 910 | 850 | 800 |
| G66 | 320811 | 980 | 920 | 850 |
| G76 | 320812 | 1,030 | 990 | 910 |
| G90 | 320813 | 1,090 | 1,030 | 920 |

CLEAR ANODIZED

| MODEL | ITEM # | 1-2 | 3-6 | 7+ |
|-------|--------|---------|---------|-------|
| G50 | 320818 | \$1,120 | \$1,050 | \$950 |
| G56 | 320819 | 1,190 | 1,160 | 1,080 |
| G66 | 320820 | 1,270 | 1,200 | 1,160 |
| G76 | 320821 | 1,330 | 1,300 | 1,200 |
| G90 | 320822 | 1,420 | 1,330 | 1,260 |

BRONZE ANODIZED

| MODEL | ITEM # | 1-2 | 3-6 | 7+ |
|-------|--------|---------|---------|---------|
| G50 | 320827 | \$1,180 | \$1,140 | \$1,050 |
| G56 | 320828 | 1,270 | 1,200 | 1,160 |
| G66 | 320829 | 1,330 | 1,270 | 1,200 |
| G76 | 320830 | 1,500 | 1,460 | 1,350 |
| G90 | 320831 | 1,640 | 1,560 | 1,460 |

BLACK ANODIZED

| MODEL | ITEM # | 1-2 | 3-6 | 7+ |
|-------|--------|---------|---------|---------|
| G50 | 320836 | \$1,230 | \$1,180 | \$1,120 |
| G56 | 320837 | 1,330 | 1,270 | 1,200 |
| G66 | 320838 | 1,430 | 1,350 | 1,270 |
| G76 | 320839 | 1,650 | 1,580 | 1,470 |
| G90 | 320840 | 1,770 | 1,660 | 1,580 |

VERTICAL WALL MOUNT SERIES

External Halyard Cone Tapered Aluminum Flagpoles



BRACKETS FOR 2-3/8\"/>



BRACKETS FOR 6\"/>



BRACKETS FOR 7\"/>



Recommended minimum spread between brackets: 10% of the length of the pole

STANDARD ACCESSORIES

- Gold anodized aluminum ball ornament
- Cast aluminum revolving truck on 5" & 6" diameter poles; all others have a stationary truck as standard
- Cast aluminum cleat with mounting screws
- Solid braided polyester halyard
- Swivel flag snaps with vinyl covers
- Cast aluminum mounting brackets
- If thru wall bolts are required, please advise length of bolt needed.

| MODEL | OVERALL LENGTH | # OF SECTIONS | BUTT DIA. | TOP DIA. | WALL | REC. FLAG SIZE | SHIPPING WEIGHT |
|---------|----------------|---------------|-----------|----------|------|----------------|-----------------|
| EVWM8 | 8' | 1 | 2-3/8" | 1-7/8" | .140 | 3' x 5' | 31 lbs. |
| EVWM10 | 10' | 1 | 2-3/8" | 1-7/8" | .140 | 3' x 5' | 35 lbs. |
| EVWM12 | 12' | 1 | 2-3/8" | 1-7/8" | .140 | 3' x 5' | 38 lbs. |
| EVWS8 | 8' | 1 | 3" | 1-7/8" | .125 | 3' x 5' | 31 lbs. |
| EVWS10 | 10' | 1 | 3" | 1-7/8" | .125 | 3' x 5' | 34 lbs. |
| EVWS12 | 12' | 1 | 3" | 1-7/8" | .125 | 3' x 5' | 38 lbs. |
| EVWS14 | 14' | 1 | 3" | 1-7/8" | .125 | 3' x 5' | 42 lbs. |
| EVWS17 | 17' | 1 | 3" | 1-7/8" | .125 | 3' x 5' | 48 lbs. |
| EVWS20 | 20' | 1 | 3" | 1-7/8" | .125 | 3' x 5' | 53 lbs. |
| EVWS22 | 22' | 1 | 3" | 1-7/8" | .125 | 3' x 5' | 57 lbs. |
| EVWS25 | 25' | 1 | 3" | 1-7/8" | .125 | 3' x 5' | 63 lbs. |
| EVWS27 | 27' | 1 | 3" | 1-7/8" | .125 | 3' x 5' | 67 lbs. |
| EVW12 | 12' | 1 | 3-1/2" | 2-3/8" | .125 | 3' x 5' | 44 lbs. |
| EVW16 | 16' | 1 | 3-1/2" | 2-3/8" | .125 | 3' x 5' | 52 lbs. |
| EVW20 | 20' | 1 | 3-1/2" | 2-3/8" | .125 | 3' x 5' | 59 lbs. |
| EVW22 | 22' | 1 | 3-1/2" | 2-3/8" | .125 | 3' x 5' | 66 lbs. |
| EVW25 | 25' | 1 | 3-1/2" | 2-3/8" | .125 | 4' x 6' | 75 lbs. |
| EVW27 | 27' | 1 | 3-1/2" | 2-3/8" | .125 | 4' x 6' | 77 lbs. |
| EVWAF16 | 16' | 1 | 4" | 2-3/8" | .125 | 3' x 5' | 81 lbs. |
| EVWAF20 | 20' | 1 | 4" | 2-3/8" | .125 | 3' x 5' | 94 lbs. |
| EVWAF22 | 22' | 1 | 4" | 2-3/8" | .125 | 3' x 5' | 101 lbs. |
| EVWAF25 | 25' | 1 | 4" | 2-3/8" | .125 | 4' x 6' | 110 lbs. |
| EVWAF27 | 27' | 1 | 4" | 2-3/8" | .125 | 4' x 6' | 117 lbs. |
| EVWAF30 | 30' | 1 or 2* | 4" | 2-3/8" | .125 | 5' x 8' | 178 lbs. |
| LVW20 | 20' | 1 | 5" | 3" | .125 | 4' x 6' | 97 lbs. |
| LVWC20 | 20' | 1 | 5" | 3" | .188 | 4' x 6' | 99 lbs. |
| LVW23 | 23' | 1 | 5" | 3" | .125 | 4' x 6' | 108 lbs. |
| LVWC23 | 23' | 1 | 5" | 3" | .188 | 4' x 6' | 111 lbs. |
| LVW25 | 25' | 1 | 5" | 3" | .125 | 4' x 6' | 115 lbs. |
| LVWA25 | 25' | 1 | 5" | 3" | .156 | 4' x 6' | 131 lbs. |
| LVW27 | 27' | 1 | 5" | 3" | .125 | 4' x 6' | 123 lbs. |
| LVWA27 | 27' | 1 | 5" | 3" | .156 | 4' x 6' | 139 lbs. |
| LVW30 | 30' | 1 or 2* | 6" | 3-1/2" | .156 | 5' x 8' | 178 lbs. |
| LVWC30 | 30' | 1 or 2* | 6" | 3-1/2" | .188 | 5' x 8' | 230 lbs. |
| LVW33 | 33' | 1 or 2* | 6" | 3-1/2" | .156 | 5' x 8' | 192 lbs. |
| LVWC33 | 33' | 1 or 2* | 6" | 3-1/2" | .188 | 5' x 8' | 250 lbs. |
| LVW35 | 35' | 1 or 2* | 6" | 3-1/2" | .156 | 6' x 10' | 201 lbs. |

* Flagpole models available in both one and two section styles; please specify when placing your order. Single section pole(s) will be shipped if not specified. **Add 10% to the pricing for two section style flagpoles.**

Illustration depicting 5-6" butt dia. poles

OUTDOOR FLAGPOLES | Vertical Wall Mount

VERTICAL WALL MOUNT SERIES

External Halyard Cone Tapered Aluminum Flagpoles

COMPLETE SETS INCLUDING BRACKETS

| MODEL | SATIN | | | | CLEAR ANODIZED | | | | BRONZE ANODIZED | | | | BLACK ANODIZED | | | |
|---------|--------|-------|-------|-------|----------------|---------|---------|---------|-----------------|---------|---------|---------|----------------|---------|---------|---------|
| | ITEM # | 1-2 | 3-6 | 7+ | ITEM # | 1-2 | 3-6 | 7+ | ITEM # | 1-2 | 3-6 | 7+ | ITEM # | 1-2 | 3-6 | 7+ |
| EVWM8 | 322698 | \$990 | \$940 | \$900 | 322739 | \$1,260 | \$1,190 | \$1,140 | 322780 | \$1,300 | \$1,230 | \$1,180 | 322821 | \$1,320 | \$1,260 | \$1,190 |
| EVWM10 | 322699 | 1,030 | 980 | 910 | 322740 | 1,300 | 1,230 | 1,180 | 322781 | 1,330 | 1,270 | 1,200 | 322822 | 1,350 | 1,300 | 1,220 |
| EVWM12 | 322700 | 1,090 | 990 | 940 | 322741 | 1,330 | 1,270 | 1,200 | 322782 | 1,420 | 1,330 | 1,260 | 322823 | 1,430 | 1,350 | 1,270 |
| EVWS8 | 322705 | 800 | 780 | 750 | 322746 | 1,000 | 930 | 860 | 322787 | 1,010 | 960 | 870 | 322828 | 1,050 | 1,000 | 920 |
| EVWS10 | 322706 | 820 | 790 | 760 | 322747 | 1,050 | 1,000 | 910 | 322788 | 1,120 | 1,010 | 930 | 322829 | 1,140 | 1,050 | 1,000 |
| EVWS12 | 322707 | 850 | 820 | 790 | 322748 | 1,140 | 1,050 | 960 | 322789 | 1,160 | 1,080 | 1,000 | 322830 | 1,180 | 1,120 | 1,050 |
| EVWS14 | 322708 | 940 | 910 | 830 | 322749 | 1,180 | 1,120 | 1,050 | 322790 | 1,200 | 1,160 | 1,080 | 322831 | 1,230 | 1,180 | 1,120 |
| EVWS17 | 322709 | 1,030 | 940 | 910 | 322750 | 1,260 | 1,190 | 1,140 | 322791 | 1,270 | 1,200 | 1,160 | 322832 | 1,320 | 1,260 | 1,190 |
| EVWS20 | 322710 | 1,090 | 990 | 920 | 322751 | 1,300 | 1,230 | 1,180 | 322792 | 1,400 | 1,320 | 1,230 | 322833 | 1,420 | 1,330 | 1,260 |
| EVWS22 | 322711 | 1,150 | 1,100 | 1,030 | 322752 | 1,350 | 1,270 | 1,220 | 322793 | 1,430 | 1,350 | 1,270 | 322834 | 1,470 | 1,400 | 1,320 |
| EVWS25 | 322712 | 1,240 | 1,160 | 1,120 | 322753 | 1,470 | 1,400 | 1,300 | 322794 | 1,500 | 1,460 | 1,350 | 322835 | 1,550 | 1,470 | 1,350 |
| EVWS27 | 322713 | 1,280 | 1,210 | 1,150 | 322754 | 1,500 | 1,460 | 1,330 | 322795 | 1,580 | 1,490 | 1,420 | 322836 | 1,590 | 1,500 | 1,430 |
| EVW12 | 322714 | 1,640 | 1,590 | 1,480 | 322755 | 1,860 | 1,750 | 1,650 | 322796 | 2,130 | 2,040 | 1,950 | 322837 | 2,240 | 2,130 | 2,030 |
| EVW16 | 322715 | 1,700 | 1,620 | 1,530 | 322756 | 1,950 | 1,860 | 1,700 | 322797 | 2,220 | 2,110 | 1,980 | 322838 | 2,340 | 2,220 | 2,110 |
| EVW20 | 322716 | 1,750 | 1,630 | 1,550 | 322757 | 1,980 | 1,920 | 1,830 | 322798 | 2,260 | 2,150 | 2,040 | 322839 | 2,430 | 2,300 | 2,150 |
| EVW22 | 322717 | 1,790 | 1,670 | 1,590 | 322758 | 2,040 | 1,950 | 1,860 | 322799 | 2,340 | 2,220 | 2,110 | 322840 | 2,520 | 2,360 | 2,230 |
| EVW25 | 322718 | 1,840 | 1,720 | 1,630 | 322759 | 2,070 | 1,980 | 1,880 | 322800 | 2,390 | 2,240 | 2,130 | 322841 | 2,590 | 2,440 | 2,260 |
| EVW27 | 322719 | 1,920 | 1,800 | 1,670 | 322760 | 2,120 | 2,030 | 1,930 | 322801 | 2,440 | 2,310 | 2,170 | 322842 | 2,690 | 2,530 | 2,340 |
| EVWAF16 | 322720 | 2,020 | 1,940 | 1,840 | 322761 | 2,450 | 2,340 | 2,220 | 322802 | 2,570 | 2,430 | 2,260 | 322843 | 2,710 | 2,570 | 2,400 |
| EVWAF20 | 322721 | 2,070 | 1,980 | 1,900 | 322762 | 2,530 | 2,390 | 2,240 | 322803 | 2,690 | 2,530 | 2,340 | 322844 | 2,750 | 2,630 | 2,520 |
| EVWAF22 | 322722 | 2,090 | 1,990 | 1,920 | 322763 | 2,590 | 2,440 | 2,260 | 322804 | 2,720 | 2,590 | 2,440 | 322845 | 2,820 | 2,710 | 2,570 |
| EVWAF25 | 322723 | 2,180 | 2,080 | 1,980 | 322764 | 2,900 | 2,760 | 2,630 | 322805 | 2,760 | 2,690 | 2,530 | 322846 | 2,890 | 2,730 | 2,610 |
| EVWAF27 | 322724 | 2,210 | 2,110 | 2,000 | 322765 | 2,980 | 2,790 | 2,700 | 322806 | 2,820 | 2,720 | 2,590 | 322847 | 2,980 | 2,790 | 2,700 |
| EVWAF30 | 322725 | 2,480 | 2,360 | 2,210 | 322766 | 3,090 | 2,940 | 2,780 | 322807 | 3,150 | 3,000 | 2,840 | 322848 | 3,190 | 3,080 | 2,900 |
| LVW20 | 322726 | 2,490 | 2,360 | 2,200 | 322767 | 3,050 | 2,900 | 2,750 | 322808 | 3,350 | 3,150 | 2,990 | 322849 | 3,500 | 3,330 | 3,080 |
| LVWC20 | 322727 | 2,950 | 2,830 | 2,710 | 322768 | 3,630 | 3,440 | 3,220 | 322809 | 3,920 | 3,700 | 3,530 | 322850 | 4,010 | 3,830 | 3,640 |
| LVW23 | 322728 | 2,540 | 2,390 | 2,260 | 322769 | 3,090 | 2,980 | 2,790 | 322810 | 3,420 | 3,170 | 3,010 | 322851 | 3,530 | 3,380 | 3,160 |
| LVWC23 | 322729 | 2,990 | 2,850 | 2,730 | 322770 | 3,690 | 3,530 | 3,320 | 322811 | 3,970 | 3,740 | 3,590 | 322852 | 4,030 | 3,750 | 3,620 |
| LVW25 | 322730 | 2,580 | 2,470 | 2,300 | 322771 | 3,330 | 3,090 | 2,960 | 322812 | 3,520 | 3,370 | 3,140 | 322853 | 3,570 | 3,430 | 3,190 |
| LVWA25 | 322731 | 2,930 | 2,770 | 2,650 | 322772 | 3,620 | 3,500 | 3,330 | 322813 | 3,700 | 3,530 | 3,370 | 322854 | 3,940 | 3,750 | 3,570 |
| LVW27 | 322732 | 2,660 | 2,490 | 2,350 | 322773 | 3,350 | 3,150 | 2,990 | 322814 | 3,540 | 3,400 | 3,170 | 322855 | 3,600 | 3,480 | 3,240 |
| LVWA27 | 322733 | 2,960 | 2,810 | 2,680 | 322774 | 3,700 | 3,530 | 3,350 | 322815 | 3,750 | 3,570 | 3,420 | 322856 | 4,010 | 3,820 | 3,600 |
| LVW30 | 322734 | 3,740 | 3,530 | 3,370 | 322775 | 4,670 | 4,430 | 4,220 | 322816 | 4,770 | 4,500 | 4,310 | 322857 | 4,870 | 4,670 | 4,400 |
| LVWC30 | 322735 | 4,000 | 3,810 | 3,560 | 322776 | 4,910 | 4,680 | 4,440 | 322817 | 4,970 | 4,760 | 4,490 | 322858 | 5,190 | 4,910 | 4,670 |
| LVW33 | 322736 | 3,820 | 3,630 | 3,460 | 322777 | 4,730 | 4,460 | 4,270 | 322818 | 4,840 | 4,640 | 4,380 | 322859 | 4,960 | 4,750 | 4,460 |
| LVWC33 | 322737 | 4,040 | 3,840 | 3,630 | 322778 | 4,970 | 4,760 | 4,490 | 322819 | 5,000 | 4,790 | 4,560 | 322860 | 5,270 | 4,960 | 4,710 |
| LVW35 | 322738 | 3,830 | 3,640 | 3,470 | 322779 | 4,820 | 4,570 | 4,370 | 322820 | 4,950 | 4,730 | 4,430 | 322861 | 5,060 | 4,810 | 4,560 |

BRACKETS ONLY

Mounting Hardware Not Included & Priced Separately on [Page 144](#)

| FOR POLE DIA. | MODEL | LBS | SATIN* | | | | BRONZE | | | | BLACK | | | |
|---------------|---------|-----|--------|-------|-------|-------|--------|-------|-------|-------|--------|-------|-------|-------|
| | | | ITEM # | 1-2 | 3-6 | 7+ | ITEM # | 1-2 | 3-6 | 7+ | ITEM # | 1-2 | 3-6 | 7+ |
| 2-3/8" | EVWM/B | 4.1 | 323026 | \$260 | \$250 | \$210 | 323040 | \$310 | \$295 | \$285 | 323047 | \$310 | \$295 | \$285 |
| 3" | EVWS/B | 7.7 | 323027 | 260 | 250 | 210 | 323041 | 310 | 295 | 285 | 323048 | 310 | 295 | 285 |
| 3-1/2" | EVW/B | 6.9 | 323028 | 620 | 590 | 550 | 323042 | 660 | 640 | 620 | 323049 | 660 | 640 | 620 |
| 4" | EVWAF/B | 20 | 323029 | 710 | 650 | 630 | 323043 | 800 | 780 | 750 | 323050 | 800 | 780 | 750 |
| 5" | LVW/B | 14 | 323030 | 710 | 650 | 630 | 323044 | 800 | 780 | 750 | 323051 | 800 | 780 | 750 |
| 6" | LVW6/B | 25 | 323031 | 1,080 | 1,010 | 950 | 323045 | 1,140 | 1,110 | 1,050 | 323052 | 1,140 | 1,110 | 1,050 |

*Satin brackets can be used with both Satin and Clear Anodized poles

OUTRIGGER WALL MOUNT SERIES

External Halyard Aluminum Flagpoles

ECOST & ECOS

3" Diameter Poles Only
45° Angle Only

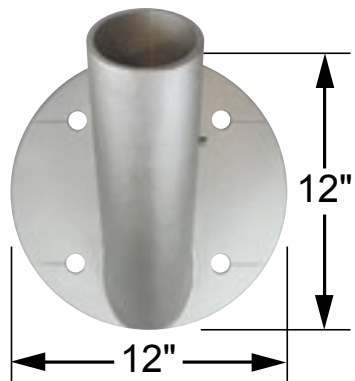

ECO

3-1/2" Diameter Poles Only
60° Angle Only



ECOM

2-3/8" Diameter Poles Only
45° Angle Only

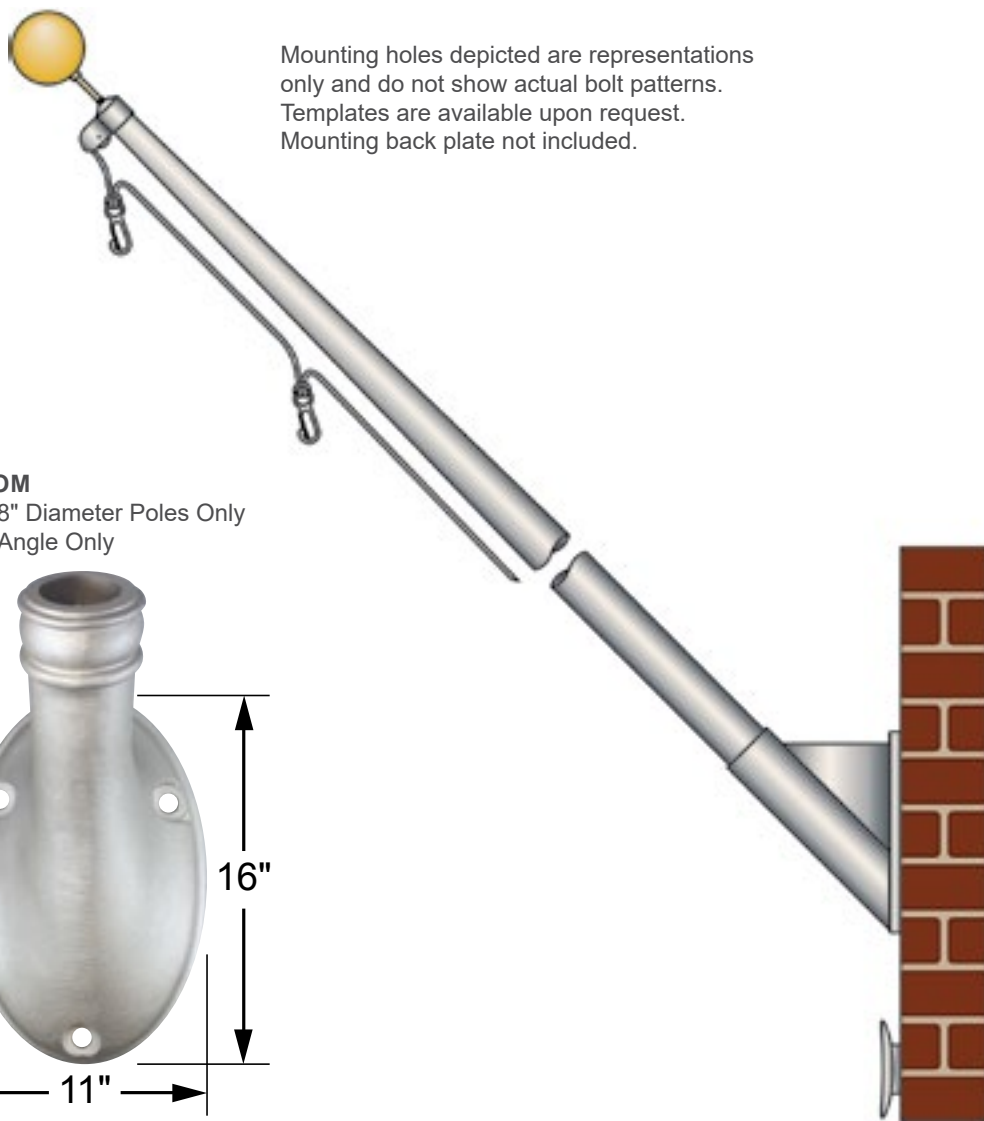
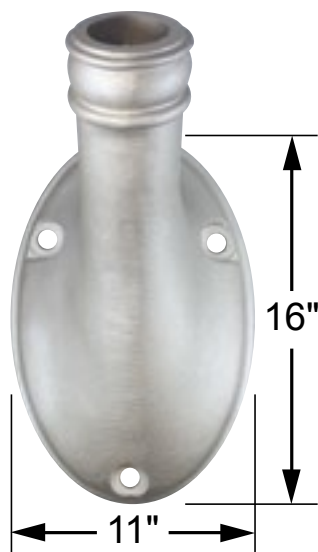

Mounting holes depicted are representations only and do not show actual bolt patterns. Templates are available upon request. Mounting back plate not included.

All Models are Cone Tapered Except the ECOS Models which are Non-Tapering Poles

| MODEL | OVERALL LENGTH | CONE TAPERED | NON-TAPERED | BUTT DIA. | TOP DIA. | WALL | SUGGESTED FLAG SIZE | SHIPPING WEIGHT |
|---------|----------------|--------------|-------------|-----------|----------|------|---------------------|-----------------|
| ECOM8 | 8' | • | | 2-3/8" | 1-7/8" | .140 | 3' x 5' | 51 lbs. |
| ECOM10 | 10' | • | | 2-3/8" | 1-7/8" | .140 | 3' x 5' | 58 lbs. |
| ECOM12 | 12' | • | | 2-3/8" | 1-7/8" | .140 | 3' x 5' | 58 lbs. |
| ECOST8 | 8' | • | | 3" | 1-7/8" | .125 | 3' x 5' | 36 lbs. |
| ECOST10 | 10' | • | | 3" | 1-7/8" | .125 | 3' x 5' | 39 lbs. |
| ECOS8 | 8' | | • | 3" | 3" | .125 | 3' x 5' | 35 lbs. |
| ECOS10 | 10' | | • | 3" | 3" | .125 | 3' x 5' | 38 lbs. |
| ECO8 | 8' | • | | 3-1/2" | 2-3/8" | .125 | 3' x 5' | 54 lbs. |
| ECO10 | 10' | • | | 3-1/2" | 2-3/8" | .125 | 3' x 5' | 58 lbs. |
| ECO12 | 12' | • | | 3-1/2" | 2-3/8" | .125 | 3' x 5' | 62 lbs. |
| ECO16 | 16' | • | | 3-1/2" | 2-3/8" | .125 | 3' x 5' | 71 lbs. |

STANDARD ACCESSORIES

- Gold anodized aluminum ball ornament
- Cast aluminum stationary truck
- Solid braided polyester halyard
- Swivel flag snaps with vinyl covers
- Cast aluminum cleat with mounting screws
- Cast aluminum mounting brackets.
- If thru wall bolts are required, please advise length of bolt needed.

OUTRIGGER WALL MOUNT SERIES

External Halyard Aluminum Flagpoles

Outrigger complete sets include bracket & mounting hardware.

SATIN COMPLETE SETS

| MODEL | ITEM # | 1-2 | 3-6 | 7+ |
|---------|--------|---------|---------|---------|
| ECOM8 | 323061 | \$1,440 | \$1,400 | \$1,310 |
| ECOM10 | 323062 | 1,470 | 1,430 | 1,310 |
| ECOM12 | 323063 | 1,520 | 1,440 | 1,330 |
| ECOST8 | 323066 | 830 | 800 | 780 |
| ECOST10 | 323067 | 850 | 830 | 800 |
| ECOS8 | 323068 | 820 | 790 | 750 |
| ECOS10 | 323069 | 830 | 800 | 780 |
| ECO8 | 324061 | 2,080 | 1,990 | 1,910 |
| ECO10 | 324057 | 2,090 | 2,020 | 1,930 |
| ECO12 | 323070 | 2,170 | 2,030 | 1,940 |
| ECO16 | 323071 | 2,190 | 2,090 | 1,990 |

CLEAR ANODIZED COMPLETE SETS

| MODEL | ITEM # | 1-2 | 3-6 | 7+ |
|---------|--------|---------|---------|---------|
| ECOM8 | 323073 | \$1,840 | \$1,730 | \$1,640 |
| ECOM10 | 323074 | 1,860 | 1,750 | 1,650 |
| ECOM12 | 323075 | 1,880 | 1,790 | 1,660 |
| ECOST8 | 323078 | 1,110 | 1,060 | 1,010 |
| ECOST10 | 323079 | 1,180 | 1,140 | 1,060 |
| ECOS8 | 323080 | 950 | 910 | 860 |
| ECOS10 | 323081 | 1,050 | 960 | 930 |
| ECO8 | 324062 | 2,780 | 2,700 | 2,530 |
| ECO10 | 324058 | 2,820 | 2,720 | 2,570 |
| ECO12 | 323082 | 2,870 | 2,730 | 2,600 |
| ECO16 | 323083 | 2,900 | 2,760 | 2,630 |

BRONZE ANODIZED COMPLETE SETS

| MODEL | ITEM # | 1-2 | 3-6 | 7+ |
|---------|--------|---------|---------|---------|
| ECOM8 | 323085 | \$2,110 | \$2,020 | \$1,920 |
| ECOM10 | 323086 | 2,130 | 2,040 | 1,940 |
| ECOM12 | 323087 | 2,170 | 2,070 | 1,970 |
| ECOST8 | 323090 | 1,140 | 1,080 | 1,010 |
| ECOST10 | 323091 | 1,200 | 1,180 | 1,110 |
| ECOS8 | 323092 | 1,010 | 950 | 870 |
| ECOS10 | 323093 | 1,080 | 1,050 | 960 |
| ECO8 | 324063 | 2,860 | 2,730 | 2,590 |
| ECO10 | 324059 | 2,890 | 2,760 | 2,610 |
| ECO12 | 323094 | 2,910 | 2,780 | 2,690 |
| ECO16 | 323095 | 2,990 | 2,820 | 2,710 |

BLACK ANODIZED COMPLETE SETS

| MODEL | ITEM # | 1-2 | 3-6 | 7+ |
|---------|--------|---------|---------|---------|
| ECOM8 | 323097 | \$2,120 | \$2,030 | \$1,940 |
| ECOM10 | 323098 | 2,150 | 2,070 | 1,970 |
| ECOM12 | 323099 | 2,220 | 2,120 | 2,020 |
| ECOST8 | 323102 | 1,220 | 1,180 | 1,110 |
| ECOST10 | 323103 | 1,230 | 1,200 | 1,180 |
| ECOS8 | 323104 | 1,080 | 1,050 | 950 |
| ECOS10 | 323105 | 1,140 | 1,080 | 1,010 |
| ECO8 | 324064 | 2,910 | 2,780 | 2,630 |
| ECO10 | 324060 | 2,960 | 2,820 | 2,700 |
| ECO12 | 323106 | 2,980 | 2,820 | 2,690 |
| ECO16 | 323107 | 3,000 | 2,860 | 2,710 |

Brackets only do not include mounting hardware. Mounting hardware priced separately on [Page 144](#)

SATIN* BRACKET ONLY

| MODEL | ITEM # | 1-2 | 3-6 | 7+ |
|---------|--------|-------|-------|-------|
| ECOM/B | 323157 | \$820 | \$800 | \$770 |
| ECOST/B | 323158 | 480 | 470 | 430 |
| ECO/B | 323159 | 1,640 | 1,550 | 1,470 |

*Satin brackets can be used with both Satin and Clear Anodized poles

BRONZE BRACKET ONLY

| MODEL | ITEM # | 1-2 | 3-6 | 7+ |
|---------|--------|---------|---------|---------|
| ECOM/B | 323163 | \$1,120 | \$1,050 | \$1,000 |
| ECOST/B | 323164 | 550 | 540 | 510 |
| ECO/B | 323165 | 1,860 | 1,730 | 1,640 |

BLACK BRACKET ONLY

| MODEL | ITEM # | 1-2 | 3-6 | 7+ |
|---------|--------|---------|---------|---------|
| ECOM/B | 323166 | \$1,120 | \$1,050 | \$1,000 |
| ECOST/B | 323167 | 550 | 540 | 510 |
| ECO/B | 323168 | 1,860 | 1,730 | 1,640 |

| BRACKETS ONLY SHIPPING WEIGHTS | MODEL | LBS. |
|--------------------------------|---------------|------|
| | ECOM Bracket | 26 |
| | ECOST Bracket | 8.4 |
| ECO Bracket | 22 | |

ECOM



ECOST & ECOS



ECO



TILTING SHOE BASE FLAGPOLES

All of the cone tapered aluminum flagpoles on [pages 100 through 113](#) with a 3", 4", 5" or 6" butt diameter can be supplied with a tilting shoe base. The tilting base is circumferentially welded to the base eliminating the need for a flash collar. The hinged portion of the base is held in place by (3) stainless steel, Allen head bolts and pivots on a solid aluminum pivot rod. Anchor bolts are furnished for mounting to a concrete base. Not recommended for nautical poles.

- Maximum flagpole height for Tilting Shoe Base mount is 30' exposed
- Tilting Shoe Base is not available with the Hurricane Series Flagpoles
- Adding any Shoe Base mount will reduce the wind rating of the flagpole
- Shoe Base mounts are recommended for grade level mounting only

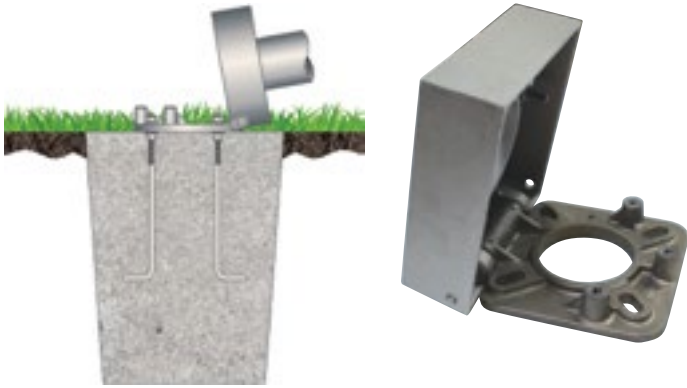

FOR TILTING SHOE BASE FLAGPOLES, ADD THE FOLLOWING PRICING TO ANY OF THE FLAGPOLES ON [PAGES 100-113](#).

| ITEM# | BUTT DIA. | 1-2 | 3-6 | 7+ |
|--------|-----------|-------|-------|-------|
| 323882 | 3" | \$800 | \$780 | \$710 |
| 323883 | 4" | 970 | 910 | 880 |
| 323884 | 5" | 990 | 960 | 890 |
| 323885 | 6" | 990 | 960 | 890 |

SHOE BASE FLAGPOLES

All of the cone tapered aluminum flagpoles on [pages 100 through 113](#) can be supplied with a shoe base mounting. The aluminum base is circumferentially welded to the flagpole shaft. A spun aluminum flash collar is supplied as standard unless otherwise specified. Anchor bolts are furnished for mounting to a concrete base.

- Adding any Shoe Base mount will reduce the wind rating of the flagpole
- Shoe Base mounts are recommended for grade level mounting only



FOR SHOE BASE FLAGPOLES, ADD THE FOLLOWING PRICING TO ANY OF THE FLAGPOLES ON [PAGES 100-113](#).

| ITEM# | BUTT DIA. | 1-2 | 3-6 | 7+ |
|--------|-----------|-------------------|-------|-------|
| 323887 | 3" | \$490 | \$480 | \$460 |
| 323889 | 4" | 530 | 510 | 490 |
| 323890 | 5" | 600 | 550 | 540 |
| 323891 | 6" | 620 | 600 | 560 |
| 323892 | 7" | 630 | 620 | 600 |
| 323893 | 8" | 670 | 660 | 630 |
| — | 10** | Call for pricing. | | |
| — | 12** | Call for pricing. | | |

*In addition to a shoe base, a mandrel is inserted into pole for added structural support.

Alternative bases on page 119 cannot be sold separately. Must be added at time of purchase of flagpole.

FRANKLIN SERIES

The Franklin series comes complete with 1-1/2" diameter clear anodized aluminum pole, 3" gold anodized aluminum ball ornament, cast aluminum single-sheave stationary truck, 50' of 1/4" solid braided polyester halyard, (2) nylon flag snaps per halyard, 9" cast aluminum cleat(s) with mounting screws and cast or fabricated aluminum mounting bracket(s). Mounting hardware not included.



OUTRIGGER SETS

With Bracket

| MODEL | ITEM # | LEN. | 1-2 | 3-6 | 7+ | LBS. |
|-------|--------|------|-------|-------|-------|------|
| EOA6 | 323403 | 6' | \$560 | \$540 | \$500 | 14 |
| EOA9 | 323404 | 9' | 620 | 610 | 570 | 17 |
| EOA10 | 323405 | 10' | 630 | 620 | 610 | 18 |



OUTRIGGER BRACKET

Displays Pole at 30° Angle

Mounting Hardware Not Included

| MODEL | ITEM # | 1-2 | 3-6 | 7+ | LBS. |
|-------|--------|-------|-------|-------|------|
| EOA | 323422 | \$195 | \$193 | \$191 | 3.4 |



VERTICAL WALL SETS

With Brackets

| MODEL | ITEM # | LEN. | 1-2 | 3-6 | 7+ | LBS. |
|--------|--------|------|-------|-------|-------|------|
| EVWA6 | 323415 | 6' | \$530 | \$500 | \$460 | 13 |
| EVWA9 | 323416 | 9' | 580 | 570 | 560 | 16 |
| EVWA10 | 323417 | 10' | 620 | 610 | 570 | 17 |
| EVWA12 | 323418 | 12' | 630 | 620 | 580 | 19 |



VERTICAL WALL BRACKETS

Mounting Hardware Not Included

Priced Per Set of Top & Bottom Bracket

| MODEL | ITEM # | 1-2 | 3-6 | 7+ | LBS. |
|-------|--------|-------|-------|-------|------|
| EVWA | 323426 | \$188 | \$176 | \$163 | 2.2 |

CLEAR ANODIZED POLES ONLY

| ITEM # | DIAMETER | LENGTH | WALL | PRICE | LBS. |
|--------|----------|--------|------|-------|------|
| 310039 | 1-1/2" | 72" | .125 | \$85 | 3.7 |
| 323739 | 1-1/2" | 96" | .125 | 123 | 4.6 |
| 323427 | 1-1/2" | 108" | .125 | 133 | 5.6 |
| 323428 | 1-1/2" | 120" | .125 | 149 | 6.2 |
| 323429 | 1-1/2" | 144" | .125 | 180 | 7.4 |

ALUMINUM BALL ORNAMENTS



Gold



Clear



Satin

| MODEL | DIA. | SPINDLE THREADING | LBS. | GOLD ANODIZED | | | CLEAR ANODIZED | | | SATIN | | |
|-------|------|-------------------|------|---------------|------|------|----------------|------|------|--------|------|------|
| | | | | ITEM # | 1-5 | 6+ | ITEM # | 1-5 | 6+ | ITEM # | 1-5 | 6+ |
| SB102 | 2" | 1/2"-13NC | .16 | 330089 | \$26 | \$21 | — | — | — | — | — | — |
| SB103 | 3" | 1/2"-13NC | .30 | 330000 | 38 | 34 | 330007 | \$49 | \$48 | 330082 | \$47 | \$45 |
| SB104 | 4" | 1/2"-13NC | .45 | 330001 | 48 | 46 | 330008 | 64 | 59 | 330083 | 57 | 54 |
| SB105 | 5" | 1/2"-13NC | .60 | 330002 | 56 | 51 | 330009 | 74 | 68 | 330084 | 61 | 57 |
| SB106 | 6" | 1/2"-13NC | .80 | 330003 | 70 | 62 | 330010 | 104 | 93 | 330085 | 82 | 73 |
| SB108 | 8" | 1/2"-13NC | 1.4 | 330004 | 126 | 116 | 330011 | 159 | 144 | 330086 | 130 | 123 |
| SB110 | 10" | 5/8"-11NC | 2.2 | 330005 | 238 | 213 | 330012 | 245 | 228 | 330087 | 227 | 218 |
| SB112 | 12" | 5/8"-11NC | 3.1 | 330006 | 303 | 278 | 330013 | 308 | 278 | 330088 | 268 | 264 |

| MODEL | DIA. | SPINDLE THREADING | LBS. | BRONZE #313 | | | BLACK | | | WHITE | | |
|-------|------|-------------------|------|-------------|------|------|--------|------|------|--------|------|------|
| | | | | ITEM # | 1-5 | 6+ | ITEM # | 1-5 | 6+ | ITEM # | 1-5 | 6+ |
| SB103 | 3" | 1/2"-13NC | .30 | 330014 | \$51 | \$49 | 330021 | \$51 | \$49 | 330028 | \$51 | \$49 |
| SB104 | 4" | 1/2"-13NC | .45 | 330015 | 65 | 59 | 330022 | 65 | 59 | 330029 | 65 | 59 |
| SB105 | 5" | 1/2"-13NC | .60 | 330016 | 76 | 73 | 330023 | 76 | 73 | 330030 | 76 | 73 |
| SB106 | 6" | 1/2"-13NC | .80 | 330017 | 104 | 93 | 330024 | 104 | 93 | 330031 | 104 | 93 |
| SB108 | 8" | 1/2"-13NC | 1.4 | 330018 | 162 | 146 | 330025 | 162 | 146 | 330032 | 162 | 146 |
| SB110 | 10" | 5/8"-11NC | 2.2 | 330019 | 294 | 267 | 330026 | 294 | 267 | 330033 | 294 | 267 |
| SB112 | 12" | 5/8"-11NC | 3.1 | 330020 | 363 | 329 | 330027 | 363 | 329 | 330034 | 363 | 329 |



Satin



Mirror

STAINLESS STEEL BALL ORNAMENTS

| MODEL | DIA. | SPINDLE THREADING | LBS. | SATIN FINISH | | | MIRROR FINISH | | |
|-------|------|-------------------|------|--------------|-------|-------|---------------|-------|-------|
| | | | | ITEM # | 1-5 | 6+ | ITEM # | 1-5 | 6+ |
| SS104 | 4" | 1/2"-13NC | 1.5 | 330035 | \$296 | \$270 | 330041 | \$376 | \$338 |
| SS105 | 5" | 1/2"-13NC | 2.0 | 330036 | 364 | 331 | 330042 | 446 | 399 |
| SS106 | 6" | 1/2"-13NC | 2.5 | 330037 | 376 | 341 | 330043 | 477 | 420 |
| SS108 | 8" | 1/2"-13NC | 4.1 | 330038 | 473 | 428 | 330044 | 571 | 518 |
| SS110 | 10" | 5/8"-11NC | 6.1 | 330039 | 656 | 591 | 330045 | 802 | 720 |
| SS112 | 12" | 5/8"-11NC | 7.8 | 330040 | 805 | 729 | 330046 | 940 | 860 |



GOLD LEAF COPPER BALL ORNAMENTS

| MODEL | ITEM # | DIA. | SPINDLE THREADING | 1-5 | 6+ | LBS. |
|-------|--------|------|-------------------|-------|-------|------|
| GL104 | 330047 | 4" | 1/2"-13NC | \$383 | \$345 | 1.5 |
| GL105 | 330048 | 5" | 1/2"-13NC | 450 | 427 | 2.0 |
| GL106 | 330049 | 6" | 1/2"-13NC | 550 | 526 | 2.6 |
| GL108 | 330050 | 8" | 5/8"-11NC | 1,005 | 958 | 4.2 |
| GL110 | 330051 | 10" | 5/8"-11NC | 1,495 | 1,431 | 7.7 |
| GL112 | 330052 | 12" | 5/8"-11NC | 2,201 | 2,093 | 8.1 |



COPPER BALL ORNAMENTS

| MODEL | ITEM # | DIA. | SPINDLE THREADING | 1-5 | 6+ | LBS. |
|-------|--------|------|-------------------|-------|-------|------|
| CB104 | 330091 | 4" | 1/2"-13NC | \$242 | \$230 | 1.5 |
| CB105 | 330092 | 5" | 1/2"-13NC | 303 | 288 | 2.0 |
| CB106 | 330093 | 6" | 1/2"-13NC | 362 | 345 | 2.5 |
| CB108 | 330094 | 8" | 5/8"-11NC | 477 | 456 | 4.1 |
| CB110 | 330095 | 10" | 5/8"-11NC | 702 | 668 | 4.9 |
| CB112 | 330096 | 12" | 5/8"-11NC | 1,183 | 1,124 | 6.5 |

If medium bronze #312, light bronze #311 or a custom color is desired please specify when ordering.

ALUMINUM FLYING EAGLES



E-11 Gold



E-16 Gold



E-24 Gold

| MODEL | WING SPAN | HEIGHT | SPINDLE THREADING | LBS. | GOLD | | |
|-------|-----------|--------|-------------------|------|--------|-------|-------|
| | | | | | ITEM # | 1-5 | 6+ |
| E-11 | 11-1/4" | 12" | 1/2"-13NC | 2.7 | 330055 | \$173 | \$164 |
| E-16 | 15" | 18" | 1/2"-13NC | 5.4 | 330056 | 218 | 204 |
| E-24 | 24" | 10" | 1/2"-13NC | 6.4 | 330057 | 381 | 347 |

GOLD ANODIZED ALUMINUM GLOBE FOR E-16 EAGLE

Slips Over The Spindle of the E-16 Eagle



| ITEM # | DIAMETER | PRICE | LBS. |
|--------|----------|---------|------|
| 330090 | 3" | \$27.80 | .07 |

METAL EAGLE ORNAMENTS

Gold Powder Coated Painted Finish



| MODEL | ITEM # | WING SPAN | HT. | SPINDLE THREADING | PRICE | LBS. |
|--------|--------|-----------|--------|-------------------|---------|------|
| E-8PC | 050538 | 8-1/4" | 7" | 1/2"-13NC | \$62.00 | 1.4 |
| E-9PC | 330098 | 9-1/4" | 7-1/4" | 1/2"-13NC | 107.00 | 2.0 |
| E-12PC | 330097 | 12" | 8-1/2" | 1/2"-13NC | 112.00 | 3.3 |



PLAIN ALUMINUM CROSSES

Painted Gold

| MODEL | ITEM # | CROSS HT. | CROSS WIDTH | SPINDLE THREADING | 1-5 | 6+ | LBS. |
|-------|--------|-----------|-------------|-------------------|-------|-------|------|
| PC8 | 330078 | 8-1/2" | 4-1/4" | 1/2"-13NC | \$159 | \$146 | 1.3 |
| PC12 | 330079 | 13" | 6-3/4" | 1/2"-13NC | 220 | 204 | 1.7 |



ALUMINUM BOTONÉE CROSSES

Painted Gold

| MODEL | ITEM # | CROSS HT. | CROSS WIDTH | SPINDLE THREADING | 1-5 | 6+ | LBS. |
|-------|--------|-----------|-------------|-------------------|-------|-------|------|
| BC12 | 330081 | 12" | 12" | 5/8"-11NC | \$264 | \$237 | 6.8 |



ST-1 SERIES

- **Construction:** cast aluminum
- **Pulley:** 1" outside diameter cast nylon on 3/16" stainless steel axle
- **Max halyard diameter:** 1/4"
- **Truck:** secured by 1 stainless steel set screw (size 1/4"-20NC)
- **Ornaments*:** accepts spindle threading of 1/2"-13NC. Secured by 1 stainless steel pan head screw (size 10-32)

For External Halyard Poles • Cap Style • Stationary • Single Pulley

| MODEL | FITS POLE DIAMETER | LBS. | SILVER | | | BRONZE #313 | | | WHITE | | | BLACK | | |
|---------|--------------------|------|--------|---------|---------|-------------|---------|---------|--------|---------|---------|--------|---------|---------|
| | | | ITEM # | 1-5 | 6+ | ITEM # | 1-5 | 6+ | ITEM # | 1-5 | 6+ | ITEM # | 1-5 | 6+ |
| ST-1-38 | 1-3/8" | 1.0 | 340000 | \$43.50 | \$40.00 | 340005 | \$49.50 | \$44.50 | 340010 | \$49.50 | \$44.50 | 340015 | \$49.50 | \$44.50 |
| ST-1-12 | 1-1/2" | 1.0 | 340001 | 43.50 | 40.00 | 340006 | 49.50 | 44.50 | 340011 | 49.50 | 44.50 | 340016 | 49.50 | 44.50 |
| ST-1-34 | 1-3/4" | .90 | 340002 | 43.50 | 40.00 | 340007 | 49.50 | 44.50 | 340012 | 49.50 | 44.50 | 340017 | 49.50 | 44.50 |
| ST-1-16 | 1-15/16" | .80 | 340003 | 43.50 | 40.00 | 340008 | 49.50 | 44.50 | 340013 | 49.50 | 44.50 | 340018 | 49.50 | 44.50 |
| ST-1-20 | 2" | .80 | 340004 | 43.50 | 40.00 | 340009 | 49.50 | 44.50 | 340014 | 49.50 | 44.50 | 340019 | 49.50 | 44.50 |



ST-32 SERIES

- **Construction:** cast aluminum
- **Pulleys:** 1-1/2" outside diameter cast nylon on 1/4" stainless steel axles
- **Max halyard diameter:** 5/16"
- **Truck:** secured by 3 stainless steel set screws (size 5/16"-18NC)
- **Ornaments*:** accepts spindle threading of 1/2"-13NC. Secured by 1 stainless steel set screw (1/4"-20NC)

For External Halyard Poles • Cap Style • Stationary • Double Pulley

| MODEL | FITS POLE DIAMETER | LBS. | SILVER | | | BRONZE #313 | | | WHITE | | | BLACK | | |
|-------|--------------------|------|--------|------|------|-------------|------|------|--------|------|------|--------|------|------|
| | | | ITEM # | 1-5 | 6+ | ITEM # | 1-5 | 6+ | ITEM # | 1-5 | 6+ | ITEM # | 1-5 | 6+ |
| ST-3 | 1-7/8" | 1.9 | 340040 | \$88 | \$80 | 340042 | \$94 | \$88 | 340044 | \$94 | \$88 | 340046 | \$94 | \$88 |
| ST-2 | 2-3/8" | 1.7 | 340041 | 88 | 80 | 340043 | 94 | 88 | 340045 | 94 | 88 | 340047 | 94 | 88 |



OT SERIES

- **Construction:** cast aluminum
- **Pulley:** cast nylon on 1/4" stainless steel axle (1-1/2" outside diameter on OTH, OT1, OT25, OT35; 2" on OT2, OT3, OT325)
- **Max halyard diameter:** 5/16"
- **Truck:** secured by stainless steel set screws (one 1/4"-20NC on OTH; three 5/16"-18NC on OT1, OT2, OT25, OT3, OT325, OT35)
- **Ornaments*:** accepts spindle threading of 1/2"-13NC. Secured by 1 stainless steel pan head screw (size 10-32)

For External Halyard Poles • Cap Style • Stationary • Single Pulley

| MODEL | FITS POLE DIAMETER | LBS. | SILVER | | | BRONZE #313 | | | WHITE | | | BLACK | | |
|-------|--------------------|------|--------|---------|---------|-------------|---------|---------|--------|---------|---------|--------|---------|---------|
| | | | ITEM # | 1-5 | 6+ | ITEM # | 1-5 | 6+ | ITEM # | 1-5 | 6+ | ITEM # | 1-5 | 6+ |
| OT178 | 1-7/8" | .60 | 340364 | \$40.00 | \$37.50 | 340365 | \$44.50 | \$41.00 | 340366 | \$44.50 | \$41.00 | 340367 | \$44.50 | \$41.00 |
| OTH | 2" | .55 | 340056 | 40.00 | 37.50 | 340062 | 44.50 | 41.00 | 340068 | 44.50 | 41.00 | 340074 | 44.50 | 41.00 |
| OT1 | 2-3/8" | .95 | 340057 | 55.50 | 44.50 | 340063 | 60.00 | 56.00 | 340069 | 60.00 | 56.00 | 340075 | 60.00 | 56.00 |
| OT25 | 2-1/2" | .95 | 340058 | 57.50 | 49.50 | 340064 | 67.00 | 58.00 | 340070 | 67.00 | 58.00 | 340076 | 67.00 | 58.00 |
| OT2 | 2-3/4" | 1.5 | 340059 | 61.50 | 54.50 | 340065 | 70.00 | 60.00 | 340071 | 70.00 | 60.00 | 340077 | 70.00 | 60.00 |
| OT3 | 3" | 1.3 | 340060 | 68.50 | 57.50 | 340066 | 75.00 | 67.00 | 340072 | 75.00 | 67.00 | 340078 | 75.00 | 67.00 |
| OT325 | 3-1/4" | 1.2 | 340343 | 70.00 | 59.00 | 340344 | 78.00 | 75.00 | 340345 | 78.00 | 75.00 | 340346 | 78.00 | 75.00 |
| OT35 | 3-1/2" | 1.8 | 340061 | 74.50 | 69.50 | 340067 | 80.00 | 76.00 | 340073 | 80.00 | 76.00 | 340079 | 80.00 | 76.00 |



RTC-1 SERIES

- **Construction:** cast aluminum
- **Pulley:** 1-1/2" outside diameter cast nylon on 1/4" stainless steel axle
- **Max halyard diameter:** 5/16"
- **Truck:** secured by 3 stainless steel set screws (1/4"-20NC on RTC-1-2, RTC-1-138; 5/16"-18NC on RTC-1-238)
- **Ornaments*:** accepts spindle threading of 1/2"-13NC. Secured by 1 stainless steel set screw (1/4"-20NC)
- **Movement:** utilizes self-lubricating ball bearing assemblies for ease of rotation, product life and strength

For External Halyard Poles • Cap Style • Revolving • Single Pulley

| MODEL | FITS POLE DIAMETER | LBS. | SILVER | | | BRONZE #313 | | | WHITE | | | BLACK | | |
|-----------|--------------------|------|--------|-------|-------|-------------|-------|-------|--------|-------|-------|--------|-------|-------|
| | | | ITEM # | 1-5 | 6+ | ITEM # | 1-5 | 6+ | ITEM # | 1-5 | 6+ | ITEM # | 1-5 | 6+ |
| RTC-1-138 | 1-3/8" | 1.8 | 340351 | \$150 | \$134 | 340308 | \$167 | \$149 | 340309 | \$167 | \$149 | 340352 | \$167 | \$149 |
| RTC-1-2 | 2" | 1.6 | 340104 | 150 | 134 | 340106 | 167 | 149 | 340108 | 167 | 149 | 340110 | 167 | 149 |
| RTC-1-238 | 2-3/8" | 1.9 | 340105 | 150 | 134 | 340107 | 167 | 149 | 340109 | 167 | 149 | 340111 | 167 | 149 |

* Truck Ornament Spindle can be supplied with other threading sizes if desired

If medium bronze #312, light bronze #311 or a custom color is desired please specify when ordering.



RTC-2 SERIES

Same description as our RTC-1 Series on [page 123](#), except:

- Pulleys: 1-15/16" outside diameter cast nylon on 1/4" stainless steel axles

For External Halyard Poles • Cap Style • Revolving • Double Pulley

| MODEL | FITS POLE DIAMETER | LBS. | SILVER | | | BRONZE #313 | | | WHITE | | | BLACK | | |
|-----------|--------------------|------|--------|-------|-------|-------------|-------|-------|--------|-------|-------|--------|-------|-------|
| | | | ITEM # | 1-5 | 6+ | ITEM # | 1-5 | 6+ | ITEM # | 1-5 | 6+ | ITEM # | 1-5 | 6+ |
| RTC-2-138 | 1-3/8" | 2.5 | 340353 | \$150 | \$134 | 340310 | \$167 | \$149 | 340311 | \$167 | \$149 | 340354 | \$167 | \$149 |
| RTC-2-2 | 2" | 2.3 | 340120 | 150 | 134 | 340122 | 167 | 149 | 340124 | 167 | 149 | 340126 | 167 | 149 |
| RTC-2-238 | 2-3/8" | 2.6 | 340121 | 150 | 134 | 340123 | 167 | 149 | 340125 | 167 | 149 | 340127 | 167 | 149 |

RTS-1 SERIES

- **Construction:** cast aluminum
- **Pulley:** 1-1/2" outside diameter cast nylon on 1/4" stainless steel axle
- **Max halyard diameter:** 5/16"
- **Truck Spindle:** 1-1/4" NPT threading
- **Flagpole:** For up to 3-1/2" outside top diameter pole w/ female fitting installed

- **Ornaments*:** accepts spindle threading of 1/2"-13NC. Secured by 1 stainless steel set screw (1/4"-20NC)
- **Movement:** utilizes self-lubricating ball bearing assemblies for ease of rotation, product life and strength



For External Halyard Poles • Threaded • Revolving • Single Pulley

| MODEL | FITS POLE DIAMETER | LBS. | SILVER | | | BRONZE #313 | | | WHITE | | | BLACK | | |
|-----------|--------------------|------|--------|-------|-------|-------------|-------|-------|--------|-------|-------|--------|-------|-------|
| | | | ITEM # | 1-5 | 6+ | ITEM # | 1-5 | 6+ | ITEM # | 1-5 | 6+ | ITEM # | 1-5 | 6+ |
| RTS-1-125 | 3-1/2" | 1.9 | 340136 | \$123 | \$111 | 340137 | \$134 | \$123 | 340138 | \$134 | \$123 | 340139 | \$134 | \$123 |

RTA-1 SERIES

- **Construction:** cast aluminum
- **Pulley:** 1-1/2" outside diameter machined aluminum on 1/4" stainless steel axle
- **Max halyard diameter:** 5/16"
- **Truck Spindle:** 1-1/4" NPT threading
- **Flagpole:** For up to 3-1/2" outside top diameter pole w/ female fitting installed

- **Ornaments*:** accepts spindle threading of 1/2"-13NC. Secured by 1 stainless steel set screw (1/4"-20NC)
- **Movement:** utilizes self-lubricating ball bearing assemblies for ease of rotation, product life and strength



For External Halyard Poles • Threaded • Revolving • Single Pulley

| MODEL | FITS POLE DIAMETER | LBS. | SILVER | | | BRONZE #313 | | | WHITE | | | BLACK | | |
|-----------|--------------------|------|--------|-------|-------|-------------|-------|-------|--------|-------|-------|--------|-------|-------|
| | | | ITEM # | 1-5 | 6+ | ITEM # | 1-5 | 6+ | ITEM # | 1-5 | 6+ | ITEM # | 1-5 | 6+ |
| RTA-1-125 | 3-1/2" | 2.0 | 340360 | \$138 | \$126 | 340361 | \$148 | \$138 | 340362 | \$148 | \$138 | 340363 | \$148 | \$138 |

RTS-2 SERIES

Same description as our RTS-1 Series above, except:

- Pulleys: 1-15/16" outside diameter cast nylon on 1/4" stainless steel axles

For External Halyard Poles • Threaded • Revolving • Double Pulley



| MODEL | FITS POLE DIAMETER | LBS. | SILVER | | | BRONZE #313 | | | WHITE | | | BLACK | | |
|-----------|--------------------|------|--------|-------|-------|-------------|-------|-------|--------|-------|-------|--------|-------|-------|
| | | | ITEM # | 1-5 | 6+ | ITEM # | 1-5 | 6+ | ITEM # | 1-5 | 6+ | ITEM # | 1-5 | 6+ |
| RTS-2-125 | 3-1/2" | 2.6 | 340144 | \$134 | \$123 | 340145 | \$140 | \$128 | 340146 | \$140 | \$128 | 340147 | \$140 | \$128 |

HDT-1 SERIES

- **Construction:** cast aluminum
- **Pulley:** 2-1/2" outside diameter cast aluminum on 1/2" stainless steel axle
- **Max halyard diameter:** 3/8"
- **Truck Spindle:** 1-1/4" NPT threading
- **Flagpole:** up to 6" outside top diameter pole w/ female fitting installed

- **Ornaments*:** accepts spindle threading of 1/2"-13NC. Secured by 1 stainless steel set screw (1/4"-20NC)
- **Movement:** utilizes enclosed stainless steel bearings and raceway



For External Halyard Poles • Threaded • Revolving • Single Pulley

| MODEL | FITS POLE DIAMETER | LBS. | SILVER | | | BRONZE #313 | | | WHITE | | | BLACK | | |
|-------|--------------------|------|--------|-------|-------|-------------|-------|-------|--------|-------|-------|--------|-------|-------|
| | | | ITEM # | 1-5 | 6+ | ITEM # | 1-5 | 6+ | ITEM # | 1-5 | 6+ | ITEM # | 1-5 | 6+ |
| HDT-1 | 6" | 4.8 | 340335 | \$284 | \$258 | 340336 | \$308 | \$278 | 340337 | \$308 | \$278 | 340338 | \$308 | \$278 |

* Truck Ornament Spindle can be supplied with other threading sizes if desired

If medium bronze #312, light bronze #311 or a custom color is desired please specify when ordering.



For External Halyard Poles • Threaded • Revolving • Double Pulley

HDT-2 SERIES

Same description as our HDT-1 Series on [page 124](#), except:

- **Pulleys:** 3-3/4" outside diameter cast aluminum on 1/2" stainless steel axles

| MODEL | FITS POLE DIAMETER | LBS. | SILVER | | | BRONZE #313 | | | WHITE | | | BLACK | | |
|-------|--------------------|------|--------|-------|-------|-------------|-------|-------|--------|-------|-------|--------|-------|-------|
| | | | ITEM # | 1-5 | 6+ | ITEM # | 1-5 | 6+ | ITEM # | 1-5 | 6+ | ITEM # | 1-5 | 6+ |
| HDT-2 | 5-1/2" | 5.1 | 340152 | \$324 | \$294 | 340153 | \$350 | \$317 | 340154 | \$350 | \$317 | 340155 | \$350 | \$317 |



For External Halyard Poles • Threaded • Revolving • Double Pulley

EXTRA HEAVY-DUTY SERIES

- **Construction:** cast aluminum
- **Pulleys:** 3-7/8" outside diameter cast aluminum on 1/2" stainless steel axles
- **Max Halyard Diameter:** 3/8"
- **Truck Spindle:** 1-1/4" NPT threading
- **Flagpole:** For up to 12-3/4" outside top diameter pole w/ female fitting installed
- **Ornaments*:** accepts spindle threading of 1/2"-13NC. Secured by 1 stainless steel set screw (1/4"-20NC)
- **Movement:** utilizes stainless steel sealed lubricant ball bearing assemblies for ease of rotation, product life and strength

| MODEL | SPINDLE MATERIAL | LBS. | SILVER | | | BRONZE #313 | | | WHITE | | | BLACK | | |
|---------|------------------|------|--------|---------|---------|-------------|---------|---------|--------|---------|---------|--------|---------|---------|
| | | | ITEM # | 1-5 | 6+ | ITEM # | 1-5 | 6+ | ITEM # | 1-5 | 6+ | ITEM # | 1-5 | 6+ |
| XHDT | ALUMINUM | 9.7 | 340160 | \$1,195 | \$1,075 | 340162 | \$1,265 | \$1,140 | 340164 | \$1,265 | \$1,140 | 340166 | \$1,265 | \$1,140 |
| XHDT-SS | STAINLESS STEEL | 12 | 340161 | 2,300 | 2,060 | 340163 | 2,340 | 2,095 | 340165 | 2,340 | 2,095 | 340167 | 2,340 | 2,095 |



For Rope Style Internal Halyard Poles
Cap Style • Stationary • Single Pulley

IH-1 SERIES

- **Construction:** cast aluminum
- **Internal Pulley:** 1-1/2" outside diameter cast nylon on 1/4" stainless steel axle. Pulley assembly affixed to inside of truck by 5/16"-18NC stainless steel set screw
- **External pulley:** cast nylon on 1/4" stainless steel axle (2" outside diameter on IH-1-3; 1-1/2" on IH-1-35)
- **Max halyard diameter:** 5/16"
- **Truck:** secured by 3 stainless steel set screws (size 5/16"-18NC)
- **Ornaments*:** accepts spindle threading of 1/2"-13NC. Secured by 1 stainless steel pan head screw (size 10-32)

| MODEL | FITS POLE DIAMETER | LBS. | SILVER | | | BRONZE #313 | | | WHITE | | | BLACK | | |
|---------|--------------------|------|--------|-------|------|-------------|-------|-------|--------|-------|-------|--------|-------|-------|
| | | | ITEM # | 1-5 | 6+ | ITEM # | 1-5 | 6+ | ITEM # | 1-5 | 6+ | ITEM # | 1-5 | 6+ |
| IH-1-3 | 3" | 1.6 | 340178 | \$102 | \$93 | 340180 | \$115 | \$102 | 340182 | \$115 | \$102 | 340184 | \$115 | \$102 |
| IH-1-35 | 3-1/2" | 2.3 | 340179 | 135 | 125 | 340181 | 157 | 138 | 340183 | 157 | 138 | 340185 | 157 | 138 |



For Cable Style Internal Halyard Poles
Threaded • Revolving • Single Pulley

IH-2 SERIES

- **Construction:** cast aluminum
- **Cable Bushing:** IHT-3 has a bronze fitting; all other sizes supplied with a stainless steel bushing at the cable exit point
- **Truck Spindle:** 1-1/4" NPT threading
- **Ornaments*:** accepts spindle threading of 1/2"-13NC. Secured by 1 stainless steel set screw (1/4"-20NC)
- **Movement:** IHT-3 utilizes stainless steel sealed lubricant bearing assemblies; all other sizes utilize enclosed stainless steel bearings and raceway.

| MODEL | TRUCK BASE DIA. | TRUCK HT. | MAX. POLE TOP DIA. | LBS. | SILVER | | | BRONZE #313 | | | WHITE | | | BLACK | | |
|--------|-----------------|-----------|--------------------|------|--------|-------|-------|-------------|-------|-------|--------|-------|-------|--------|-------|-------|
| | | | | | ITEM # | 1-5 | 6+ | ITEM # | 1-5 | 6+ | ITEM # | 1-5 | 6+ | ITEM # | 1-5 | 6+ |
| IHT-VR | 5" | 4-1/2" | 3" | 4.3 | 340194 | \$357 | \$325 | 340198 | \$393 | \$357 | 340206 | \$393 | \$357 | 340202 | \$393 | \$357 |
| IHT-1 | 6-1/2" | 6-1/2" | 4" | 6.4 | 340195 | 536 | 480 | 340199 | 582 | 525 | 340207 | 582 | 525 | 340203 | 582 | 525 |
| IHT-2 | 7-1/2" | 7-1/4" | 5" | 8.7 | 340196 | 646 | 581 | 340200 | 703 | 631 | 340208 | 703 | 631 | 340204 | 703 | 631 |
| IHT-3 | 10-1/2" | 8-1/2" | 7-1/2" | 13.6 | 340197 | 1,327 | 1,193 | 340201 | 1,471 | 1,321 | 340209 | 1,471 | 1,321 | 340205 | 1,471 | 1,321 |

* Truck Ornament Spindle can be supplied with other threading sizes if desired

If medium bronze #312, light bronze #311 or a custom color is desired please specify when ordering.

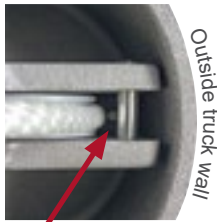

Outside truck wall

Recommended:
Thread halyard to
inside of halyard pin
stop as shown.



For Rope Style Internal Halyard Poles • Threaded •
Stationary • Single Pulley

IHT-VS SERIES

- **Construction:** cast aluminum
- **Internal Pulley:** 2" outside diameter cast nylon on 1/4" stainless steel axle. Pulley assembly affixed to inside of truck
- **Max halyard diameter:** 5/16"
- **Truck Spindle:** 1-1/4" NPT threading
- **Flagpole:** For up to 3-1/2" outside top diameter pole w/ female fitting installed
- **Ornaments*:** accepts spindle threading of 1/2"-13NC. Secured by 1 stainless steel set screw (1/4"-20NC)

| MODEL | FITS POLE DIAMETER | LBS. | SILVER | | | BRONZE #313 | | | WHITE | | | BLACK | | |
|--------|--------------------|------|--------|-------|-------|-------------|-------|-------|--------|-------|-------|--------|-------|-------|
| | | | ITEM # | 1-5 | 6+ | ITEM # | 1-5 | 6+ | ITEM # | 1-5 | 6+ | ITEM # | 1-5 | 6+ |
| IHT-VS | 3-1/2" | 2.4 | 340312 | \$140 | \$128 | 340313 | \$158 | \$140 | 340314 | \$158 | \$140 | 340315 | \$158 | \$140 |



For External Halyard Poles • Threaded • Revolving • Double Pulley

150 SERIES

- **Construction:** cast aluminum
- **Pulleys:** 1-15/16" outside diameter cast nylon on 3/8" stainless steel axles
- **Max halyard diameter:** 5/16"
- **Truck Spindle:** 1-1/2" NPT threading
- **Flagpole:** For up to 4" outside top diameter pole w/ female fitting installed
- **Ornaments*:** accepts spindle threading of 1/2"-13NC. Secured by 1 stainless steel set screw (1/4"-20NC)
- **Movement:** utilizes 26 stainless steel ball bearings on cast races for rotation

| MODEL | FITS POLE DIAMETER | LBS. | SILVER | | | BRONZE #313 | | | WHITE | | | BLACK | | |
|-----------|--------------------|------|--------|-------|-------|-------------|-------|-------|--------|-------|-------|--------|-------|-------|
| | | | ITEM # | 1-5 | 6+ | ITEM # | 1-5 | 6+ | ITEM # | 1-5 | 6+ | ITEM # | 1-5 | 6+ |
| RTS-2-150 | 4" | 2.6 | 340170 | \$226 | \$204 | 340171 | \$256 | \$226 | 340172 | \$256 | \$226 | 340173 | \$256 | \$226 |



For External Halyard Poles • Slip Fit • Stationary • Double Pulley

FIBERGLASS-2 SERIES

- **Construction:** molded fiberglass
- **Pulleys:** 1-1/2" outside diameter cast nylon on 1/4" stainless steel axles
- **Max halyard diameter:** 5/16"
- **Truck Stem:** designed to slip into a 3" outside diameter pole top. The truck is held in place by drilling thru the pole and securing the truck to the pole with screws and locktite (included)
- **Ornaments:** accepts spindle threading of 1/2"-13NC.

| COLOR | ITEM # | FITS POLE DIA. | 1-5 | 6+ | LBS. |
|-------|--------|-----------------|-------|-------|------|
| WHITE | 340228 | 3" OUTSIDE DIA. | \$174 | \$157 | 2.5 |



For Internal Halyard Poles • Slip Fit • Stationary • Single Pulley

FIBERGLASS-IH SERIES

- **Construction:** molded fiberglass
- **Pulley:** 1-1/2" outside diameter cast nylon on a 1/4" stainless steel axle
- **Max halyard diameter:** 5/16"
- **Truck Stem:** designed to slip into a 3" outside diameter pole top. The truck is held in place by drilling thru the pole and securing the truck to the pole with screws and locktite (included)
- **Ornaments:** accepts spindle threading of 1/2"-13NC.

| COLOR | ITEM # | FITS POLE DIA. | 1-5 | 6+ | LBS. |
|-------|--------|-----------------|-------|-------|------|
| WHITE | 340232 | 3" OUTSIDE DIA. | \$174 | \$157 | 2.8 |

* Truck Ornament Spindle can be supplied with other threading sizes if desired

If medium bronze #312, light bronze #311 or a custom color is desired please specify when ordering.



POLE TOP ADAPTERS

These adapters are used when mounting a truck that has a spindle threading of 1-1/4" NPT and the pole does not have a threaded top plug installed. The adapter is tapped 1-1/4" NPT and is designed to slip over the top of the pole and is secured by three 1/4"-20NC stainless steel set screws. Please specify color when ordering. If not specified, silver will be supplied.

| MODEL | FITS POLE DIAMETER | LBS. | SILVER | | | BRONZE #313 | | | WHITE | | | BLACK | | |
|---------|--------------------|------|--------|------|------|-------------|------|------|--------|------|------|--------|------|------|
| | | | ITEM # | 1-5 | 6+ | ITEM # | 1-5 | 6+ | ITEM # | 1-5 | 6+ | ITEM # | 1-5 | 6+ |
| PTA-238 | 2-3/8" | .65 | 340238 | \$86 | \$80 | 340247 | \$96 | \$86 | 340256 | \$96 | \$86 | 340265 | \$96 | \$86 |
| PTA-212 | 2-1/2" | .68 | 340239 | 86 | 80 | 340248 | 96 | 86 | 340257 | 96 | 86 | 340266 | 96 | 86 |
| PTA-3 | 3" | 1.0 | 340240 | 120 | 110 | 340249 | 130 | 119 | 340258 | 130 | 119 | 340267 | 130 | 119 |
| PTA-312 | 3-1/2" | 1.3 | 340241 | 120 | 110 | 340250 | 130 | 119 | 340259 | 130 | 119 | 340268 | 130 | 119 |
| PTA-4 | 4" | 1.6 | 340242 | 144 | 126 | 340251 | 156 | 140 | 340260 | 156 | 140 | 340269 | 156 | 140 |
| PTA-412 | 4-1/2" | 2.0 | 340243 | 144 | 126 | 340252 | 156 | 140 | 340261 | 156 | 140 | 340270 | 156 | 140 |
| PTA-5 | 5" | 2.4 | 340244 | 144 | 126 | 340253 | 156 | 140 | 340262 | 156 | 140 | 340271 | 156 | 140 |
| PTA-512 | 5-1/2" | 2.9 | 340245 | 188 | 168 | 340254 | 203 | 182 | 340263 | 203 | 182 | 340272 | 203 | 182 |
| PTA-6 | 6" | 3.8 | 340246 | 188 | 168 | 340255 | 203 | 182 | 340264 | 203 | 182 | 340273 | 203 | 182 |



FLAGPOLE CAPS

Cast aluminum construction designed to slip over the top of the flagpole and be secured with three 1/4"-20NC stainless steel set screws. The top of the cap is designed to accept an ornament with a spindle threading of 1/2"-13NC as standard but can be supplied with other sizes of threading or no threading. Please specify color when ordering. If not specified, silver will be supplied.

| MODEL | FITS POLE DIAMETER | LBS. | SILVER | | | BRONZE #313 | | | WHITE | | | BLACK | | |
|--------|--------------------|------|--------|---------|---------|-------------|---------|---------|--------|---------|---------|--------|---------|---------|
| | | | ITEM # | 1-5 | 6+ | ITEM # | 1-5 | 6+ | ITEM # | 1-5 | 6+ | ITEM # | 1-5 | 6+ |
| FC-20 | 2" | .60 | 340274 | \$34.00 | \$30.50 | 340276 | \$39.00 | \$36.50 | 340278 | \$39.00 | \$36.50 | 340280 | \$39.00 | \$36.50 |
| FC-212 | 2-1/2" | .60 | 340275 | 39.00 | 36.50 | 340277 | 42.00 | 39.50 | 340279 | 42.00 | 39.50 | 340281 | 42.00 | 39.50 |



DELUXE

STANDARD

PULLEY & EYEBOLT ASSEMBLIES

Includes Hex Nut, Washer & Lock Washer

| MODEL | ITEM # | OVERALL LENGTH | THREAD LENGTH | BOLT THREADING | BOLT MATERIAL | PULLEY HOUSING MATERIAL | PULLEY MATERIAL | MAX. ROPE DIAMETER | 1-5 | 6+ | LBS. |
|----------|--------|----------------|---------------|----------------|-------------------|-------------------------|-----------------|--------------------|---------|---------|------|
| DELUXE | 340236 | 4-1/8" | 2-3/8" | 5/16"-18NC | STAINLESS STEEL | STAINLESS STEEL | NYLON | 5/16" | \$31.00 | \$29.50 | .02 |
| STANDARD | 340237 | 3-1/8" | 1" | #8-32NC | ZINC PLATED STEEL | ZINC | ZINC | 3/16" | 9.30 | 8.50 | .07 |

NYLON

ROPE PULLEYS



ALUMINUM



| ITEM # | DIA. | WIDTH | MATERIAL | MAXIMUM AXLE DIA. | MAXIMUM ROPE DIA. | USED WITH OUR TRUCK MODEL NUMBER... | 1-5 | 6+ | LBS. |
|---------|----------|-------|----------|-------------------|-------------------|--|--------|--------|------|
| 340302 | 1" | 3/8" | NYLON | 3/16" | 1/4" | ST-1-38, ST-1-12, ST-1-16, ST-1-20 | \$5.40 | \$4.90 | .01 |
| 340356* | 1-1/2" | 1/2" | NYLON | 1/4" | 1/4" | OTH, IH-1-35, OT35 | 7.50 | 6.50 | .03 |
| 340355 | 1-1/2" | 9/16" | NYLON | 1/4" | 1/4" | ST2, ST3, OT1, OT25, IH-1 INNER PULLEY INSERT | 7.50 | 6.50 | .03 |
| 340358 | 1-1/2" | 3/4" | NYLON | 1/4" | 5/16" | RTS-1-125, RTC-1-138, RTC-1-2, RTC-1-238 | 7.90 | 7.50 | .04 |
| 340357 | 1-15/16" | 9/16" | NYLON | 1/4" | 5/16" | RTS-2-125, RTC-2-138, RTC-2-2, RTC-2-238, RTSB | 7.90 | 7.50 | .04 |
| 340320 | 2" | 1/2" | NYLON | 1/4" | 5/16" | OT2, OT3, OT325, IH-1-3, IHT-VS | 6.50 | 5.90 | .04 |
| 340359 | 2-1/2" | 7/8" | ALUMINUM | 1/2" | 3/8" | HDT-1 | 37.50 | 34.00 | .40 |
| 340305 | 3-3/4" | 3/4" | ALUMINUM | 1/2" | 3/8" | HDT-2 | 38.00 | 35.00 | .45 |

*340356 is also used with our Vertical Mount Pulley Assemblies. Please note that the diameter of all of our nylon pulleys can vary plus or minus 1/16".



VERTICAL MOUNT PULLEY ASSEMBLIES

Cast aluminum construction. 1-1/2" outside diameter cast nylon pulley on a 1/4" stainless steel axle. Attaches with two 1/4"-20NC stainless steel flat head screws or two stainless steel straps (not included). Maximum halyard diameter is 5/16". Not supplied as standard with holes drilled for mounting. Add \$2.00 for drilling.

| ITEM # | COLOR | 1-5 | 6+ | LBS. |
|--------|-------------|---------|---------|------|
| 340298 | SILVER | \$44.00 | \$40.50 | .60 |
| 340299 | BRONZE #313 | 49.50 | 45.50 | .60 |
| 340300 | BLACK | 49.50 | 45.50 | .60 |
| 340301 | WHITE | 49.50 | 45.50 | .60 |



THREADED TOP PLUGS

Screws into top of pole with 1-1/4" NPT threading and allows for insertion of ornament with either a 1/2"-13NC or 5/8"-11NC spindle threading.

| ITEM # | FOR ORNAMENT SPINDLE SIZE | 1-5 | 6+ | LBS. |
|--------|---------------------------|---------|---------|------|
| 340306 | 1/2"-13NC | \$46.50 | \$42.50 | .25 |
| 340307 | 5/8"-11NC | 51.50 | 45.50 | .25 |

If medium bronze #312, light bronze #311 or a custom color is desired please specify when ordering.



STANDARD CAST ALUMINUM CLEATS

Two 1/4"-20NC Stainless Steel Mounting Screws Included
Standard colors are: Silver, Bronze #313, White & Black.
If not specified when ordering, Silver will be supplied.

| MODEL | LENGTH | DISTANCE BETWEEN BOLT CENTERS | LBS. | SILVER | | | BRONZE #313 | | | WHITE | | | BLACK | | |
|-------|--------|-------------------------------|------|--------|---------|---------|-------------|---------|---------|--------|---------|---------|--------|---------|---------|
| | | | | ITEM # | 1-5 | 6+ | ITEM # | 1-5 | 6+ | ITEM # | 1-5 | 6+ | ITEM # | 1-5 | 6+ |
| CL6 | 6" | 2" | .25 | 350000 | \$15.20 | \$13.80 | 350002 | \$18.80 | \$16.30 | 350004 | \$18.80 | \$16.30 | 350006 | \$18.80 | \$16.30 |
| CL9 | 9" | 2-3/4" | .55 | 350001 | 20.90 | 18.20 | 350003 | 23.00 | 20.80 | 350005 | 23.00 | 20.80 | 350007 | 23.00 | 20.80 |



LIGHT-DUTY CAST ALUMINUM CLEATS

Two #10-5/8" Self-Tapping Flat Head Mounting Screws Included
Standard colors are: Silver, Bronze #313, White & Black.
If not specified when ordering, Silver will be supplied.

| MODEL | LENGTH | DISTANCE BETWEEN BOLT CENTERS | LBS. | SILVER | | | BRONZE #313 | | | WHITE | | | BLACK | | |
|-------|--------|-------------------------------|------|--------|--------|--------|-------------|---------|--------|--------|---------|--------|--------|---------|--------|
| | | | | ITEM # | 1-5 | 6+ | ITEM # | 1-5 | 6+ | ITEM # | 1-5 | 6+ | ITEM # | 1-5 | 6+ |
| CLC | 4-1/2" | 3/4" | .04 | 350008 | \$7.80 | \$7.40 | 350010 | \$10.40 | \$9.20 | 350012 | \$10.40 | \$9.20 | 350014 | \$10.40 | \$9.20 |
| CLH | 6" | 1" | .06 | 350009 | 8.30 | 7.90 | 350011 | 11.40 | 10.90 | 350013 | 11.40 | 10.90 | 350015 | 11.40 | 10.90 |



HEAVY-DUTY CAST ALUMINUM CLEAT

Two 3/8"-16NC Stainless Steel Slotted Flat Head Screws Included
Standard colors are: Silver, Bronze #313, White & Black.
If not specified when ordering, Silver will be supplied.

| LENGTH | DISTANCE BETWEEN BOLT CENTERS | LBS. | SILVER | | | BRONZE #313 | | | WHITE | | | BLACK | | |
|---------|-------------------------------|------|--------|----------|----------|-------------|----------|----------|--------|----------|----------|--------|----------|----------|
| | | | ITEM # | 1-5 | 6+ | ITEM # | 1-5 | 6+ | ITEM # | 1-5 | 6+ | ITEM # | 1-5 | 6+ |
| 14-3/4" | 4-7/8" | 2.2 | 350016 | \$156.00 | \$146.00 | 350017 | \$167.00 | \$161.00 | 350018 | \$167.00 | \$161.00 | 350019 | \$167.00 | \$161.00 |



CAST NYLON CLEATS

Two #10-1-1/2" Self-Tapping Mounting Screws Included

| MODEL | ITEM # | COLOR | DISTANCE BETWEEN BOLT CENTERS | 1-5 | 6+ | LBS. |
|-------|--------|-------|-------------------------------|--------|--------|------|
| CLP-G | 350020 | GRAY | 1-1/8" | \$5.90 | \$5.40 | .07 |
| CLP-W | 350021 | WHITE | 1-1/8" | 5.90 | 5.40 | .07 |

If medium bronze #312, light bronze #311 or a custom color is desired please specify when ordering.

CLEAT SCREWS

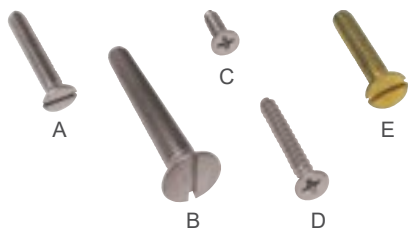

| | MATERIAL | LENGTH | THREAD | COLOR | ITEM # | PRICE | LBS. |
|---|-------------------|--------|-----------|---------------|--------|---------------|------|
| A | STAINLESS STEEL | 1-1/2" | 1/4"-20NC | Silver | 350025 | \$1.52 | .05 |
| B | ZINC PLATED STEEL | 3" | 3/8"-16NC | Silver | 350026 | 3.12 | .18 |
| C | ZINC PLATED STEEL | 5/8" | #10 | Silver | 350027 | 0.52 | .01 |
| D | ZINC PLATED STEEL | 1-1/2" | #10 | Silver | 350028 | 0.54 | .01 |
| D | STAINLESS STEEL | 1-1/2" | #14 | White Painted | 350249 | 1.60 | .05 |
| E | BRASS ALLOY | 1-1/2" | 1/4"-20NC | Brass | 350041 | 1.56 | .02 |

With
Cylinder Lock



With
Padlock



Cleat Cover Boxes can be mixed to achieve the higher quantity pricing.

CLEAT COVER BOXES

Cast aluminum with stainless steel hinge pins. Design allows for easy installation utilizing the cleat holes to mount the cleat cover box. Comes complete with your choice of padlock or cylinder lock. Two extra long 1/4"-20NC stainless steel mounting screws are included. The distance between bolt centers is 2-3/4". Rope cleat is not included - recommended cleats are the CL9 or CL9/CP; see previous page for pricing. Standard colors are Silver, or painted to match Clear, Bronze #313, White or Black.

WITH CYLINDER LOCK AND MOUNTING SCREWS

| MODEL | FITS POLE DIA. | LBS. | SILVER | | | BRONZE #313 | | |
|---------|----------------|------|--------|--------------|--------------|-------------|--------------|--------------|
| | | | ITEM # | 1-5 | 6+ | ITEM # | 1-5 | 6+ |
| CBC-335 | 3"-3½" | 5.0 | 350042 | \$212 | \$188 | 350050 | \$231 | \$212 |
| CBC-412 | 4"-12" | 5.0 | 350043 | 212 | 188 | 350051 | 231 | 212 |

| MODEL | FITS POLE DIA. | LBS. | WHITE | | | BLACK | | |
|---------|----------------|------|--------|--------------|--------------|--------|--------------|--------------|
| | | | ITEM # | 1-5 | 6+ | ITEM # | 1-5 | 6+ |
| CBC-335 | 3"-3½" | 5.0 | 350054 | \$231 | \$212 | 350058 | \$231 | \$212 |
| CBC-412 | 4"-12" | 5.0 | 350055 | 231 | 212 | 350059 | 231 | 212 |

WITH PADLOCK AND MOUNTING SCREWS

| MODEL | FITS POLE DIA. | LBS. | SILVER | | | BRONZE #313 | | |
|--------|----------------|------|--------|--------------|--------------|-------------|--------------|--------------|
| | | | ITEM # | 1-5 | 6+ | ITEM # | 1-5 | 6+ |
| CB-335 | 3"-3½" | 5.6 | 350044 | \$225 | \$203 | 350052 | \$251 | \$225 |
| CB-412 | 4"-12" | 5.6 | 350045 | 225 | 203 | 350053 | 251 | 225 |

| MODEL | FITS POLE DIA. | LBS. | WHITE | | | BLACK | | |
|--------|----------------|------|--------|--------------|--------------|--------|--------------|--------------|
| | | | ITEM # | 1-5 | 6+ | ITEM # | 1-5 | 6+ |
| CB-335 | 3"-3½" | 5.6 | 350056 | \$251 | \$225 | 350060 | \$251 | \$225 |
| CB-412 | 4"-12" | 5.6 | 350057 | 251 | 225 | 350061 | 251 | 225 |



HALYARD COVERS WITH MOUNTING SCREWS

This 1-3/4" wide by 1" deep aluminum channel is designed to be used with the cleat cover boxes above by providing additional protection 5', 6', 8', or 10' above the cleat cover box. The 5', 6', and 8' models have an upper & lower hinge assembly and is secured to the pole with six #10-32NC stainless steel pan head screws (included). The 10' model has upper, middle and lower hinge assemblies and is secured to the pole with nine #10-32NC stainless steel pan head screws (included). Note: Shown with cleat cover box which is sold separately and is not included in the pricing below. Standard colors are Silver, or painted to match Clear, Bronze #313, White or Black.

| MODEL | LENGTH | LBS. | SILVER | | | CLEAR | | | BRONZE #313 | | | WHITE | | | BLACK | | |
|-------|--------|------|--------|--------------|--------------|--------|--------------|--------------|-------------|--------------|--------------|--------|--------------|--------------|--------|--------------|--------------|
| | | | ITEM # | 1-5 | 6+ | ITEM # | 1-5 | 6+ | ITEM # | 1-5 | 6+ | ITEM # | 1-5 | 6+ | ITEM # | 1-5 | 6+ |
| HC-5 | 5' | 5.1 | 350066 | \$201 | \$178 | 350070 | \$244 | \$218 | 350074 | \$244 | \$218 | 350078 | \$244 | \$218 | 350082 | \$244 | \$218 |
| HC-6 | 6' | 5.9 | 350067 | 218 | 201 | 350071 | 271 | 244 | 350075 | 271 | 244 | 350079 | 271 | 244 | 350083 | 271 | 244 |
| HC-8 | 8' | 7.5 | 350068 | 274 | 246 | 350072 | 336 | 295 | 350076 | 336 | 295 | 350080 | 336 | 295 | 350084 | 336 | 295 |
| HC-10 | 10' | 9.5 | 350069 | 336 | 302 | 350073 | 386 | 349 | 350077 | 386 | 349 | 350081 | 386 | 349 | 350085 | 386 | 349 |

If medium bronze #312, light bronze #311 or a custom color is desired please specify when ordering.



Cylinder Lock

Padlock

LOCKS & KEYS FOR CLEAT BOXES

| MODEL | ITEM # | DESCRIPTION | 1-5 | 6+ | LBS. |
|-------|--------|----------------------------|---------|---------|------|
| CBC-L | 350090 | CYLINDER LOCK w/KEYS | \$26.40 | \$24.50 | .14 |
| CBC-K | 360292 | KEY ONLY FOR CYLINDER LOCK | 10.90 | 10.60 | .04 |
| CB-L | 350092 | PADLOCK w/KEYS | 19.50 | 17.90 | .46 |



CLEAT COVER BOX MOUNTING SCREWS

2-1/2" x 1/4"-20NC

| ITEM # | COLOR | PRICE | LBS. |
|--------|--------|--------|------|
| 350062 | SILVER | \$1.58 | .03 |



HALYARD COVER MOUNTING SCREWS

5/8" x #10-32NC Stainless Steel

| ITEM # | COLOR | PRICE | LBS. |
|--------|--------|--------|------|
| 350086 | SILVER | \$0.70 | .01 |

SEE PAGES 134 - 140 FOR INTERNAL HALYARD PARTS & ACCESSORIES



STAINLESS STEEL SPRING CLIPS

| ITEM # | LENGTH | 1-11 | 12-143 | 144+ | LBS. |
|--------|--------|--------|--------|--------|------|
| 350136 | 2-3/8" | \$4.90 | \$4.00 | \$3.80 | .06 |
| 350254 | 2-3/4" | 6.50 | 6.10 | 5.70 | .09 |

If medium bronze #312, light bronze #311 or a custom color is desired please specify when ordering.



SOLID BRASS SWIVEL SNAPS

| MODEL | ITEM # | LENGTH | 1-11 | 12-143 | 144+ | LBS. |
|-------|--------|--------|--------|--------|--------|------|
| ESS | 350124 | 3" | \$7.00 | \$6.30 | \$6.00 | .13 |
| ESSL | 350125 | 3-3/4" | 9.80 | 8.70 | 8.00 | .17 |
| ESSXL | 350126 | 4-3/4" | 16.70 | 14.80 | 14.00 | .30 |



CHROME PLATED BRASS SWIVEL SNAP

| MODEL | ITEM # | LENGTH | 1-11 | 12-143 | 144+ | LBS. |
|-------|--------|--------|--------|--------|--------|------|
| ESSC | 350128 | 3-1/2" | \$9.80 | \$8.60 | \$7.60 | .13 |

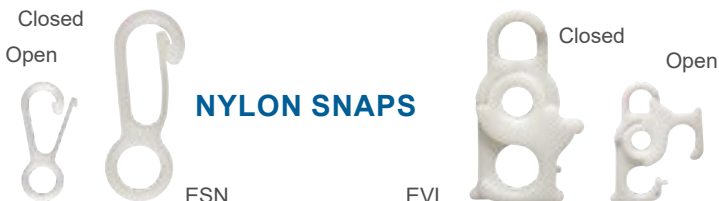

NYLON SNAPS

| MODEL | ITEM # | LENGTH | 1-11 | 12-143 | 144+ | LBS. |
|-------|--------|--------|--------|--------|--------|------|
| ESN | 350131 | 2-3/4" | \$1.24 | \$1.18 | \$1.12 | .01 |
| EVL | 350132 | 3" | 15.60 | 14.80 | 14.50 | .04 |



SOLID BRASS DOUBLE SNAP

| MODEL | ITEM # | LENGTH | 1-11 | 12-143 | 144+ | LBS. |
|-------|--------|--------|--------|--------|--------|------|
| DS-4 | 350135 | 4" | \$8.50 | \$7.60 | \$6.90 | .14 |



NICKEL PLATED ZINC SWIVEL SNAP

| MODEL | ITEM # | LENGTH | 1-11 | 12-143 | 144+ | LBS. |
|-------|--------|--------|--------|--------|--------|------|
| ESSZ | 350127 | 3-1/2" | \$5.60 | \$5.30 | \$4.80 | .10 |



STAINLESS STEEL SWIVEL SNAPS

| MODEL | ITEM # | LENGTH | 1-11 | 12-143 | 144+ | LBS. |
|-------|--------|--------|---------|---------|---------|------|
| SSFS1 | 350129 | 3-3/4" | \$28.50 | \$27.00 | \$25.50 | .13 |
| SSFS2 | 350130 | 4-3/4" | 35.00 | 32.50 | 31.00 | .28 |



RUBBER COATED BRASS SWIVEL SNAPS

| MODEL | ITEM # | LENGTH | COLOR | 1-11 | 12-143 | 144+ | LBS. |
|-------|--------|--------|-------|---------|---------|---------|------|
| ESR-W | 350133 | 3" | WHITE | \$16.10 | \$15.20 | \$12.80 | .13 |
| ESR-B | 350134 | 3" | BROWN | 16.80 | 16.10 | 13.50 | .13 |



STAINLESS STEEL SWIVEL SNAP W/LARGE EYE OPENING

Ideal for 25' x 40' flags and larger.

| MODEL | ITEM # | LENGTH | 1-11 | 12-143 | 144+ | LBS. |
|-------|--------|--------|---------|---------|---------|------|
| SSFS3 | 350257 | 4-3/4" | \$37.00 | \$35.00 | \$32.00 | .35 |



GRAY BROWN BLACK

VINYL SNAP COVERS

| MODEL | ITEM # | COLOR | LEN. | DIA. | 1-11 | 12-143 | 144+ | LBS. |
|----------|--------|-------|--------|--------|--------|--------|--------|------|
| EVC-G | 350137 | GRAY | 3-1/2" | 1-1/4" | \$3.80 | \$3.50 | \$3.40 | .05 |
| EVC-B | 350138 | BROWN | 3-1/2" | 1-1/4" | 3.80 | 3.50 | 3.40 | .05 |
| EVC-BL | 350258 | BLACK | 3-1/2" | 1-1/4" | 3.80 | 3.50 | 3.40 | .05 |
| EVCXL-G | 350139 | GRAY | 4-1/4" | 1-1/2" | 5.30 | 5.10 | 4.80 | .08 |
| EVCXL-B | 350140 | BROWN | 4-1/4" | 1-1/2" | 5.30 | 5.10 | 4.80 | .08 |
| EVCXL-BL | 350259 | BLACK | 4-1/4" | 1-1/2" | 5.30 | 5.10 | 4.80 | .08 |

POLYESTER HALYARD – SOLID BRAIDED



CUT-TO-LENGTH – Priced Per Foot

| MODEL | DIA. | LBS. | WHITE | | SILVER | | BRONZE #313 | | BLACK | |
|-------|-------|------|--------|--------|--------|--------|-------------|--------|--------|--------|
| | | | ITEM # | PRICE | ITEM # | PRICE | ITEM # | PRICE | ITEM # | PRICE |
| PH6 | 3/16" | .01 | 350195 | \$0.43 | 350200 | \$0.45 | 350204 | \$0.45 | 350208 | \$0.45 |
| PH8 | 1/4" | .01 | 350196 | 0.47 | 350201 | 0.50 | 350205 | 0.50 | 350209 | 0.50 |
| PH10 | 5/16" | .02 | 350197 | 0.54 | 350202 | 0.57 | 350206 | 0.57 | 350210 | 0.57 |
| PH12 | 3/8" | .02 | 350198 | 0.66 | 350203 | 0.75 | 350207 | 0.75 | 350211 | 0.75 |

Note: When ordering cut-to-length halyard please specify the number of feet desired. Our sales staff will convert the number of feet to the proper decimal equivalent in relationship to the appropriate spool of halyard and this information will appear on your invoice. This is being done to accommodate our computer system.

SPOOLS – Priced Per Foot



| MODEL | FEET PER SPOOL | DIA. | LBS. | WHITE | | | SILVER | | |
|-------|----------------|-------|------|--------|------------|-----------|--------|------------|-----------|
| | | | | ITEM # | 1-2 SPOOLS | 3+ SPOOLS | ITEM # | 1-2 SPOOLS | 3+ SPOOLS |
| PH6 | 1,500 | 3/16" | 16 | 350195 | \$639 | \$428 | 350200 | \$666 | \$510 |
| PH8 | 1,000 | 1/4" | 14 | 350196 | 461 | 321 | 350201 | 496 | 364 |
| PH10 | 600 | 5/16" | 11 | 350197 | 321 | 258 | 350202 | 341 | 278 |
| PH12 | 600 | 3/8" | 15 | 350198 | 396 | 300 | 350203 | 448 | 321 |
| PH16 | 250 | 1/2" | 16 | 350199 | 663 | 577 | — | — | — |

| MODEL | FEET PER SPOOL | DIA. | LBS. | BRONZE #313 | | | BLACK | | |
|-------|----------------|-------|------|-------------|------------|-----------|--------|------------|-----------|
| | | | | ITEM # | 1-2 SPOOLS | 3+ SPOOLS | ITEM # | 1-2 SPOOLS | 3+ SPOOLS |
| PH6 | 1,500 | 3/16" | 16 | 350204 | \$666 | \$510 | 350208 | \$666 | \$510 |
| PH8 | 1,000 | 1/4" | 14 | 350205 | 496 | 364 | 350209 | 496 | 364 |
| PH10 | 600 | 5/16" | 11 | 350206 | 341 | 278 | 350210 | 341 | 278 |
| PH12 | 600 | 3/8" | 15 | 350207 | 448 | 321 | 350211 | 448 | 321 |
| PH16 | 250 | 1/2" | 16 | — | — | — | — | — | — |

| MODEL | LENGTH | DIA. | LBS. | WHITE | | SILVER | | BRONZE #313 | |
|-------|--------|-------|------|--------|--------|--------|---------|-------------|---------|
| | | | | ITEM # | PRICE | ITEM # | PRICE | ITEM # | PRICE |
| NH4 | 28' | 1/8" | .12 | 350141 | \$6.50 | — | — | — | — |
| PH6 | 30' | 3/16" | .30 | 350142 | 13.50 | 350154 | \$15.00 | 350166 | \$15.00 |
| PH6 | 40' | 3/16" | .40 | 350143 | 18.00 | — | — | 350167 | 19.30 |
| PH8 | 30' | 1/4" | .34 | — | — | 350252 | 16.10 | — | — |
| PH8 | 40' | 1/4" | .45 | 350144 | 19.40 | 350156 | 22.50 | 350168 | 22.50 |
| PH8 | 50' | 1/4" | .65 | 350145 | 24.20 | 350157 | 26.50 | 350169 | 26.50 |
| PH8 | 60' | 1/4" | .75 | 350146 | 28.30 | 350158 | 30.80 | 350170 | 30.80 |
| PH10 | 40' | 5/16" | .90 | — | — | 350253 | 24.20 | — | — |
| PH10 | 50' | 5/16" | .90 | 350147 | 28.30 | 350159 | 30.80 | 350171 | 30.80 |
| PH10 | 60' | 5/16" | .95 | 350148 | 32.80 | 350160 | 34.60 | 350172 | 34.60 |
| PH10 | 70' | 5/16" | 1.2 | 350149 | 36.70 | 350161 | 40.70 | 350173 | 40.70 |
| PH10 | 80' | 5/16" | 1.4 | 350150 | 42.80 | 350162 | 44.80 | 350174 | 44.80 |
| PH10 | 90' | 5/16" | 1.5 | 350151 | 46.70 | 350163 | 50.80 | 350175 | 50.80 |
| PH10 | 100' | 5/16" | 1.5 | 350152 | 53.00 | 350164 | 56.90 | 350176 | 56.90 |
| PH12 | 120' | 3/8" | 2.5 | 350153 | 65.40 | 350165 | 72.90 | 350177 | 72.90 |

PRE-BAGGED – Priced Per Foot



POLYESTER WIRE CENTER HALYARD



CUT-TO-LENGTH – Priced Per Foot

| MODEL | DIA. | LBS. | WHITE | | SILVER | | BRONZE #313 | | BLACK | |
|--------|-------|------|--------|--------|--------|--------|-------------|--------|--------|--------|
| | | | ITEM # | PRICE | ITEM # | PRICE | ITEM # | PRICE | ITEM # | PRICE |
| NWCH6 | 3/16" | .03 | 350228 | \$0.96 | 350232 | \$1.03 | 350236 | \$1.03 | 350240 | \$1.03 |
| NWCH8 | 1/4" | .03 | 350229 | 1.03 | 350233 | 1.07 | 350237 | 1.07 | 350241 | 1.07 |
| NWCH10 | 5/16" | .04 | 350230 | 1.28 | 350234 | 1.36 | 350238 | 1.36 | 350242 | 1.36 |
| NWCH12 | 3/8" | .04 | 350231 | 1.72 | 350235 | 1.78 | 350239 | 1.78 | 350243 | 1.78 |

Note: When ordering cut-to-length halyard please specify the number of feet desired. Our sales staff will convert the number of feet to the proper decimal equivalent in relationship to the appropriate spool of halyard and this information will appear on your invoice. This is being done to accommodate our computer system.

| MODEL | FEET PER SPOOL | DIA. | LBS. | WHITE | | | SILVER | | |
|--------|----------------|-------|------|--------|------------|-----------|--------|------------|-----------|
| | | | | ITEM # | 1-2 SPOOLS | 3+ SPOOLS | ITEM # | 1-2 SPOOLS | 3+ SPOOLS |
| NWCH6 | 1,000 | 3/16" | 32 | 350228 | \$954 | \$783 | 350232 | \$1,029 | \$827 |
| NWCH8 | 1,000 | 1/4" | 35 | 350229 | 1,029 | 846 | 350233 | 1,067 | 870 |
| NWCH10 | 500 | 5/16" | 21 | 350230 | 638 | 528 | 350234 | 676 | 548 |
| NWCH12 | 500 | 3/8" | 26 | 350231 | 858 | 688 | 350235 | 890 | 714 |

| MODEL | FEET PER SPOOL | DIA. | LBS. | BRONZE #313 | | | BLACK | | |
|--------|----------------|-------|------|-------------|------------|-----------|--------|------------|-----------|
| | | | | ITEM # | 1-2 SPOOLS | 3+ SPOOLS | ITEM # | 1-2 SPOOLS | 3+ SPOOLS |
| NWCH6 | 1,000 | 3/16" | 31 | 350236 | \$1,029 | \$827 | 350240 | \$1,029 | \$827 |
| NWCH8 | 1,000 | 1/4" | 34 | 350237 | 1,067 | 870 | 350241 | 1,067 | 870 |
| NWCH10 | 500 | 5/16" | 20 | 350238 | 676 | 548 | 350242 | 676 | 548 |
| NWCH12 | 500 | 3/8" | 23 | 350239 | 890 | 714 | 350243 | 890 | 714 |

SPOOLS – Priced Per Foot



TECHNORA® FLAGPOLE HALYARD

High performance fibers are encased inside a polyester fiber yarn jacket resulting in a high strength, low stretch, U.V. and abrasion resistant flagpole halyard. Available in White.

| ITEM # | DESCRIPTION | DIA. | COLOR | PRICE | LBS. |
|--------|---------------|------|-------|---------------|------|
| 350256 | CUT-TO-LENGTH | 1/4" | WHITE | \$2.07/FOOT | .02 |
| 350256 | 1000' SPOOL | 1/4" | WHITE | \$2,070/SPOOL | 18 |

Note: When ordering cut-to-length halyard please specify the number of feet desired. Our sales staff will convert the number of feet to the proper decimal equivalent in relationship to the appropriate spool of halyard and this information will appear on your invoice. This is being done to accommodate our computer system.

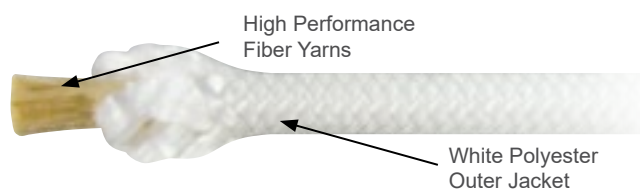

ZIPKLIP™ FLAG FASTENERS

These nylon flag fastener clips are sold two per set and come complete with stainless steel spring clips. The halyard is held firmly in place with a positive lock set screw. Maximum rope diameter 5/16".

| ITEM # | PRICE | LBS. |
|--------|------------------------|------|
| 350255 | \$15.90 PER SET OF TWO | .20 |





M-WINCHES

Standard finishes available: Satin, Clear, Bronze #313, White, Black

The maintenance-free M-Winch is gearless and self-locking at any point, eliminating the need for a separate brake. This direct drive winch provides rapid raising and lowering of the flag with little effort. The design does not require any welding, thus avoiding discoloration when an anodized finish is desired. No monthly lubrication is needed. The winch is inserted into the pole and secured with a stainless steel bolt on the back side of the pole. Comes standard with lock and keys. Other sizes available upon request.

Normal appearance of M-Winch while flag is flying or there is no flag being flown.



To remove lock, insert key, turn counter-clockwise and remove the lock exposing the winch insertion slot.



Insert handle into the winch insertion slot, apply inward pressure to locking mechanism and raise or lower the flag to desired position.



| MODEL | FITS POLE DIA. | LBS. | SATIN | | CLEAR | | BRONZE #313 | | WHITE | | BLACK | |
|--------|------------------------|------|--------|-------|--------|-------|-------------|-------|--------|-------|--------|-------|
| | | | ITEM # | Price | ITEM # | PRICE | ITEM # | PRICE | ITEM # | PRICE | ITEM # | PRICE |
| M-5 | 5" w/.125 WALL | 1.3 | 360000 | \$750 | 360009 | \$790 | 360018 | \$790 | 360027 | \$790 | 360036 | \$790 |
| M-5 | 5" w/.156 or .188 WALL | 1.3 | 360516 | 750 | 360517 | 790 | 360518 | 790 | 360519 | 790 | 360520 | 790 |
| M-6 | 6" | 2.1 | 360001 | 1,190 | 360010 | 1,230 | 360019 | 1,230 | 360028 | 1,230 | 360037 | 1,230 |
| M-6H | 6" w/.250 WALL | 2.1 | 360501 | 1,190 | 360502 | 1,230 | 360503 | 1,230 | 360505 | 1,230 | 360504 | 1,230 |
| M-7 | 7" | 2.3 | 360002 | 1,190 | 360011 | 1,230 | 360020 | 1,230 | 360029 | 1,230 | 360038 | 1,230 |
| M-8 | 8" | 4.5 | 360003 | 1,330 | 360012 | 1,400 | 360021 | 1,400 | 360030 | 1,400 | 360039 | 1,400 |
| M-10 | 10" | 4.9 | 360004 | 1,400 | 360013 | 1,450 | 360022 | 1,450 | 360031 | 1,450 | 360040 | 1,450 |
| M-10H | 10" | 4.9 | 360508 | 1,400 | 360509 | 1,450 | 360510 | 1,450 | 360512 | 1,450 | 360511 | 1,450 |
| M-1034 | 10-3/4" | 5.1 | 360005 | 1,620 | 360014 | 1,690 | 360023 | 1,690 | 360032 | 1,690 | 360041 | 1,690 |
| M-12 | 12" w/.250 WALL | 5.0 | 360466 | 1,620 | 360467 | 1,690 | 360468 | 1,690 | 360469 | 1,690 | 360470 | 1,690 |
| M-12 | 12" w/.375 WALL | 5.0 | 360006 | 1,620 | 360015 | 1,690 | 360024 | 1,690 | 360033 | 1,690 | 360042 | 1,690 |
| M-1234 | 12-3/4" | 7.9 | 360007 | 3,270 | 360016 | 3,300 | 360025 | 3,300 | 360034 | 3,300 | 360043 | 3,300 |
| M-14 | 14" | 8.1 | 360008 | 3,270 | 360017 | 3,300 | 360026 | 3,300 | 360035 | 3,300 | 360044 | 3,300 |



M-WINCH HANDLES

| MODEL | ITEM # | FOR M-WINCH MODEL # | PRICE | LBS. |
|--------|--------|---------------------|---------|------|
| MH-5 | 360045 | M-5 | \$88.00 | .50 |
| MH-612 | 360046 | M-6 THRU M-14 | 187.00 | 1.1 |

Winch Handles on this page can be mixed to achieve the higher quantity pricing.



LOCK & KEY FOR M-WINCHES

| MODEL | ITEM # | DESCRIPTION | PRICE | LBS. |
|-------|--------|-------------|----------|------|
| M-L | 360054 | LOCK w/KEY | \$117.00 | .08 |
| M-K | 360055 | KEY ONLY* | 16.00 | .01 |

*Please provide number located on cylinder lock when ordering replacement keys.

Products on Page 134 are intended for replacement parts for Eder Flag product only. The warranty on these products are only valid when used with factory installed Eder Flag shafts. Any after purchase service or warranty, must include invoice details for product and shaft.

If medium bronze #312, light bronze #311 or a custom color is desired please specify when ordering.

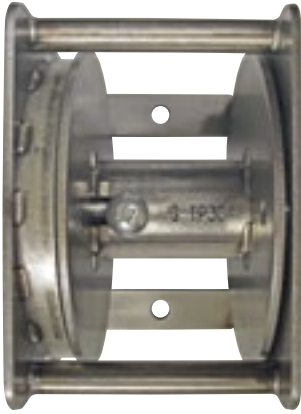

STAINLESS STEEL WINCHES

These winches are available for use on flagpoles with a butt diameter of 6" or larger. These gearless winches utilize cast bronze internal brakes which release when a winch handle is inserted and rotational pressure is applied. The winch is locked at any position by removing the handle which engages the brake system. The small size is generally used on flagpoles up to 45', the large size is used on flagpoles from 50' thru 80' and the X-Large size is used on flagpoles higher than 80'. The winch is mounted to the inside of the flagpole with two 5/16"-18NC stainless steel bolts with mounting centers being 3-1/2". Recommended stainless steel cable diameter is 1/8". Monthly lubrication required.

| MODEL | ITEM # | SIZE | MIN. POLE OPENING | | DRUM WIDTH | 1-5 | 6+ | LBS. |
|-------|--------|---------|-------------------|--------|------------|-------|-------|------|
| | | | HEIGHT | WIDTH | | | | |
| SSW1 | 360047 | SMALL | 4-1/8" | 3-1/8" | 1-1/2" | \$760 | \$730 | 3.5 |
| SSW2 | 360048 | LARGE | 4-1/8" | 3-5/8" | 2" | 760 | 730 | 3.8 |
| SSW3 | 360049 | X-LARGE | 4-1/8" | 6-5/8" | 5" | 1,310 | 1,210 | 4.8 |



HANDLE FOR STAINLESS STEEL WINCHES

Designed to be used with any of the stainless steel winches described above.

| MODEL | ITEM # | 1-5 | 6+ | LBS. |
|-------|--------|---------|---------|------|
| WH1 | 360051 | \$73.00 | \$68.00 | 1.3 |

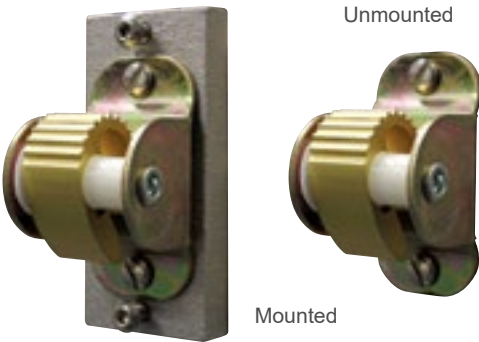

Unmounted

Mounted

CAM ACTION CLEATS

Used in rope style internal halyard flagpoles. The mounted version is secured onto a 1-1/2" x 3-3/8" aluminum block with two #10-32NC stainless steel pan head screws. Both versions are supplied with two #10-32NC stainless steel mounting screws. Recommended maximum rope diameter is 5/16".

| ITEM # | DESCRIPTION | DISTANCE BETWEEN BOLT CENTERS | 1-5 | 6+ | LBS. |
|--------|-------------|-------------------------------|---------|---------|------|
| 360052 | MOUNTED | 2-15/16" | \$57.00 | \$50.00 | .50 |
| 360053 | UNMOUNTED | 2" | 32.50 | 31.00 | .25 |



Arrangement shown with 2 Quick Links

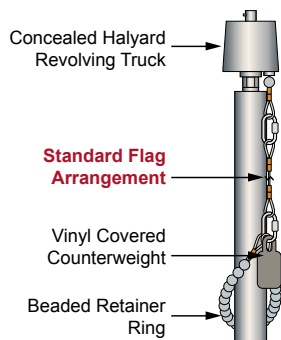

STANDARD FLAG ARRANGEMENTS

Constructed of 1/8" stainless steel aircraft cable with a stainless steel thimble attached at each end with 2 copper crimps. These flag arrangements provide the method of attaching the flag or flags to the cable assembly. This is also an excellent method for changing the quantity of flags or the size(s) of flag(s) without having to change the entire cable assembly. Standard flag arrangements are supplied with either 2 or 3 stainless steel quick links depending on the recommended flag size. Deluxe arrangements are supplied with a more complete set of accessories.

| MODEL | ITEM # | FOR FLAG SIZE | # OF QUICK LINKS | 1-5 | 6+ | LBS. |
|-------|--------|------------------------|------------------|------|------|------|
| FA1 | 360473 | 12" x 18" | 2 | \$53 | \$46 | .35 |
| FA2 | 360079 | 2' x 3' | 2 | 65 | 61 | .50 |
| FA25 | 360080 | 2-1/2' x 4' | 2 | 70 | 65 | .55 |
| FA3 | 360081 | 3' x 5' | 2 | 73 | 66 | .55 |
| FA4 | 360082 | 4' x 6' | 2 | 75 | 70 | .60 |
| FA5 | 360083 | 5' x 8' or 5' x 9-1/2' | 2 | 79 | 73 | .65 |
| FA6 | 360084 | 6' x 10' | 2 | 84 | 79 | .65 |
| FA8 | 360085 | 8' x 12' | 2 | 174 | 153 | .70 |
| FA10 | 360086 | 10' x 15' or 10' x 19' | 3 | 178 | 159 | .95 |
| FA12 | 360087 | 12' x 18' | 3 | 190 | 174 | 1.0 |
| FA15 | 360088 | 15' x 25' | 3 | 195 | 182 | 1.1 |
| FA20 | 360089 | 20' x 30' or 20' x 38' | 3 | 203 | 184 | 1.3 |
| FA25 | 360090 | 25' x 40' | 3 | 221 | 200 | 2.0 |
| FA30 | 360091 | 30' x 50' or 30' x 60' | 3 | 228 | 203 | 2.8 |

DELUXE FLAG ARRANGEMENTS

Constructed of 1/8" stainless steel aircraft cable with a stainless steel thimble attached at each end with 2 copper crimps. These flag arrangements provide the method of attaching the flag or flags to the cable assembly. This is also an excellent method for changing the quantity of flags or the size(s) of flag(s) without having to change the entire cable assembly. Deluxe flag arrangements are supplied with either 2 or 3 stainless steel quick links depending on the recommended flag size, flag snaps, shock spring where needed and safety cable where needed.

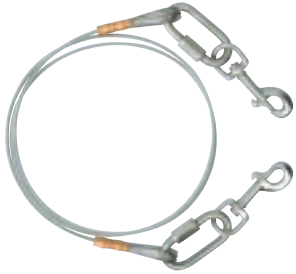

Arrangement for flag size 6' x 10' or smaller



Shock spring and Safety Cable supplied with arrangements for 8' x 12' or larger flag sizes

| MODEL | ITEM # | FOR FLAG SIZE | SUPPLIED WITH | | | | 1-5 | 6+ | LBS. |
|-------|--------|------------------------|---------------|----------------------------|--------------|--------------|------|------|------|
| | | | QUICK LINKS | FLAG SNAPS | SHOCK SPRING | SAFETY CABLE | | | |
| FA2 | 360474 | 2' x 3' | 2 | 2 (STAINLESS STEEL SSFS-1) | — | — | \$99 | \$91 | 1.2 |
| FA25 | 360475 | 2-1/2' x 4' | 2 | 2 (STAINLESS STEEL SSFS-1) | — | — | 110 | 96 | 1.3 |
| FA3 | 360476 | 3' x 5' | 2 | 2 (STAINLESS STEEL SSFS-1) | — | — | 112 | 99 | 1.3 |
| FA4 | 360477 | 4' x 6' | 2 | 2 (STAINLESS STEEL SSFS-1) | — | — | 117 | 107 | 1.3 |
| FA5 | 360478 | 5' x 8' or 5' x 9-1/2' | 2 | 2 (STAINLESS STEEL SSFS-1) | — | — | 123 | 112 | 1.4 |
| FA6 | 360479 | 6' x 10' | 2 | 2 (STAINLESS STEEL SSFS-1) | — | — | 135 | 123 | 1.4 |
| FA8 | 360480 | 8' x 12' | 3 | 2 (STAINLESS STEEL SSFS-2) | 1 | 1 | 193 | 174 | 2.3 |
| FA10 | 360481 | 10' x 15' or 10' x 19' | 3 | 2 (STAINLESS STEEL SSFS-2) | 1 | 1 | 195 | 178 | 2.6 |
| FA12 | 360482 | 12' x 18' | 3 | 2 (STAINLESS STEEL SSFS-2) | 1 | 1 | 207 | 190 | 2.6 |
| FA15 | 360483 | 15' x 25' | 3 | 2 (STAINLESS STEEL SSFS-2) | 1 | 1 | 213 | 195 | 2.7 |
| FA20 | 360484 | 20' x 30' or 20' x 38' | 3 | 2 (STAINLESS STEEL SSFS-2) | 1 | 1 | 227 | 203 | 2.9 |
| FA25 | 360485 | 25' x 40' | 3 | 2 (STAINLESS STEEL SSFS-2) | 1 | 1 | 233 | 207 | 3.6 |
| FA30 | 360486 | 30' x 50' or 30' x 60' | 3 | 2 (STAINLESS STEEL SSFS-2) | 1 | 1 | 238 | 209 | 4.4 |

CABLE ASSEMBLIES

Constructed of 1/8" and/or 3/16" stainless steel aircraft cable incorporating a stainless steel swivel to minimize the effect of unraveling due to the rotation of the truck assembly. The upper cable section is supplied with a stainless steel thimble, 2 copper crimps, and two ball cable stops, however, because this section must be threaded through the truck assembly, these parts are not attached to the cable before shipment and must be attached in the field. These standard cable assemblies are designed for flagpoles with a winch installed at 4' above grade.

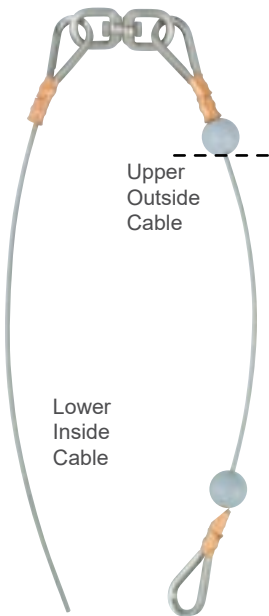

| ITEM # | EXPOSED HT. OF FLAGPOLE | LOWER INSIDE CABLE | | UPPER OUTSIDE CABLE | | 1-5 | 6+ | LBS. |
|--------|-------------------------|--------------------|----------|---------------------|---------|-------|-------|------|
| | | DIA. | LEN. | DIA. | LEN. | | | |
| 360056 | 20' | 3/32" | 17' | 1/8" | 17' | \$156 | \$143 | 1.4 |
| 360332 | 25* | 3/32" | 21' | 1/8" | 21' | 176 | 153 | 1.6 |
| 360057 | 25' | 1/8" | 21' | 1/8" | 21' | 176 | 153 | 1.9 |
| 360333 | 30* | 3/32" | 27' | 1/8" | 27' | 188 | 168 | 1.9 |
| 360058 | 30' | 1/8" | 27' | 1/8" | 27' | 188 | 168 | 2.2 |
| 360334 | 35* | 3/32" | 31-1/2' | 1/8" | 31-1/2' | 199 | 180 | 2.1 |
| 360059 | 35' | 1/8" | 31-1/2' | 1/8" | 31-1/2' | 199 | 180 | 2.5 |
| 360060 | 40' | 1/8" | 37' | 3/16" | 37' | 217 | 198 | 4.2 |
| 360061 | 45' | 1/8" | 42' | 3/16" | 42-1/2' | 227 | 206 | 4.6 |
| 360062 | 50' | 1/8" | 46' | 3/16" | 46-1/2' | 249 | 220 | 5.1 |
| 360063 | 60' | 1/8" | 56-1/2' | 3/16" | 57' | 309 | 280 | 6.1 |
| 360064 | 70' | 1/8" | 66-1/2' | 3/16" | 67' | 329 | 294 | 7.0 |
| 360065 | 78' | 1/8" | 74-1/2' | 3/16" | 75' | 338 | 309 | 7.8 |
| 360066 | 80' | 1/8" | 76-1/2' | 3/16" | 77' | 348 | 318 | 8.0 |
| 360067 | 90' | 1/8" | 86-1/2' | 3/16" | 87' | 444 | 400 | 8.9 |
| 360068 | 100' | 1/8" | 96-1/2' | 3/16" | 97' | 472 | 432 | 9.9 |
| 360069 | 110' | 1/8" | 106-1/2' | 3/16" | 107' | 492 | 444 | 11 |
| 360070 | 120' | 1/8" | 116-1/2' | 3/16" | 117' | 502 | 451 | 12 |
| 360071 | 130' | 1/8" | 126-1/2' | 3/16" | 127' | 577 | 521 | 13 |
| 360072 | 140' | 1/8" | 136-1/2' | 3/16" | 137' | 596 | 533 | 14 |
| 360073 | 150' | 1/8" | 146-1/2' | 3/16" | 147' | 637 | 577 | 15 |
| 360074 | 160' | 1/8" | 156-1/2' | 3/16" | 157' | 679 | 616 | 16 |
| 360075 | 170' | 1/8" | 166-1/2' | 3/16" | 167' | 719 | 649 | 17 |
| 360076 | 180' | 1/8" | 176-1/2' | 3/16" | 177' | 802 | 719 | 18 |
| 360077 | 190' | 1/8" | 186-1/2' | 3/16" | 187' | 861 | 776 | 19 |
| 360078 | 200' | 1/8" | 196-1/2' | 3/16" | 197' | 948 | 850 | 20 |

*To be used with 5" diameter poles with our M-5 Winch installed.



Poly Rope Assembly # 360096 shown

ROPE ASSEMBLIES

These assemblies are typically used in rope style internal halyard flagpoles where a cam cleat has been installed. Comes complete with a zinc plated carbon steel rope thimble attached to one end of the rope and stainless steel quick link.

TECHNORA® ROPE ASSEMBLIES

High performance fibers are encased inside a polyester fiber yarn jacket resulting in a high strength, low stretch, U.V. and abrasion resistant flagpole halyard.

| HT. OF POLE | LEN. OF ROPE | DIA. OF ROPE | LBS. | WHITE | | |
|-------------|--------------|--------------|------|--------|-------|------|
| | | | | ITEM # | 1-5 | 6+ |
| 20' | 50' | 1/4" | 2.0 | 360495 | \$109 | \$96 |
| 25' | 60' | 1/4" | 2.4 | 360496 | 131 | 119 |
| 30' | 70' | 1/4" | 2.7 | 360497 | 161 | 148 |
| 35' | 80' | 1/4" | 3.0 | 360498 | 174 | 152 |
| 40' | 90' | 1/4" | 3.4 | 360499 | 195 | 178 |

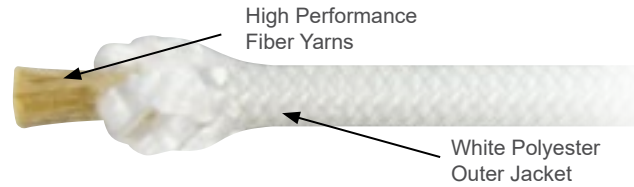

POLYESTER ROPE ASSEMBLIES

| HT. OF POLE | LEN. OF ROPE | DIA. OF ROPE | LBS. | WHITE | | | SILVER | | | BRONZE #313 | | | BLACK | | |
|-------------|--------------|--------------|------|--------|---------|---------|--------|---------|---------|-------------|---------|---------|--------|---------|---------|
| | | | | ITEM # | 1-5 | 6+ | ITEM # | 1-5 | 6+ | ITEM # | 1-5 | 6+ | ITEM # | 1-5 | 6+ |
| 20' | 50' | 1/4" | 1.7 | 360096 | \$33.00 | \$29.50 | 360106 | \$33.00 | \$29.50 | 360116 | \$33.00 | \$29.50 | 360126 | \$33.00 | \$29.50 |
| 25' | 60' | 1/4" | 2.1 | 360097 | 37.00 | 33.00 | 360107 | 38.00 | 35.00 | 360117 | 38.00 | 35.00 | 360127 | 38.00 | 35.00 |
| 30' | 70' | 1/4" | 2.4 | 360098 | 39.50 | 37.00 | 360108 | 42.00 | 38.00 | 360118 | 42.00 | 38.00 | 360128 | 42.00 | 38.00 |
| 35' | 80' | 1/4" | 2.7 | 360099 | 42.00 | 39.50 | 360109 | 44.50 | 41.00 | 360119 | 44.50 | 41.00 | 360129 | 44.50 | 41.00 |
| 40' | 90' | 1/4" | 3.1 | 360100 | 48.00 | 42.00 | 360110 | 51.50 | 44.50 | 360120 | 51.50 | 44.50 | 360130 | 51.50 | 44.50 |

POLYESTER WITH WIRE CENTER ROPE ASSEMBLIES

| HT. OF POLE | LEN. OF ROPE | DIA. OF ROPE | LBS. | WHITE | | | SILVER | | | BRONZE #313 | | | BLACK | | |
|-------------|--------------|--------------|------|--------|------|------|--------|------|------|-------------|------|------|--------|------|------|
| | | | | ITEM # | 1-5 | 6+ | ITEM # | 1-5 | 6+ | ITEM # | 1-5 | 6+ | ITEM # | 1-5 | 6+ |
| 20' | 50' | 3/16" | 1.6 | 360137 | \$57 | \$53 | 360147 | \$65 | \$58 | 360157 | \$65 | \$58 | 360167 | \$65 | \$58 |
| 25' | 60' | 3/16" | 1.9 | 360138 | 65 | 58 | 360148 | 76 | 70 | 360158 | 76 | 70 | 360168 | 76 | 70 |
| 30' | 70' | 3/16" | 2.2 | 360139 | 71 | 66 | 360149 | 87 | 79 | 360159 | 87 | 79 | 360169 | 87 | 79 |
| 35' | 80' | 3/16" | 2.5 | 360140 | 80 | 73 | 360150 | 100 | 92 | 360160 | 100 | 92 | 360170 | 100 | 92 |
| 40' | 90' | 3/16" | 2.8 | 360340 | 118 | 89 | 360341 | 126 | 116 | 360342 | 126 | 116 | 360343 | 126 | 116 |

ROPE RETAINER RINGS

Retainer rings are generally used with internal halyard flagpoles by providing a means of keeping the bottom of the flag close to the pole and as an aid to raise and lower the flag. Retainer rings can also be used on large multi-grommet flags on both external and internal flagpoles as a means to keep the flags close to the pole and reduce the strain on the upper and lower grommets of the flag. These roped retainer rings are constructed of 3/16" polyester wire center halyard with a zinc plated carbon steel thimble attached to one end with an aluminum crimp. Complete with stainless steel quick link. Standard colors are White, Silver, Bronze #313 and Black. Please specify color when ordering. If not specified White will be supplied.



| MODEL | BUTT DIA. OF POLE | LBS. | WHITE | | | SILVER | | | BRONZE #313 | | | BLACK | | |
|--------|-------------------|------|--------|---------|---------|--------|---------|---------|-------------|---------|---------|--------|---------|---------|
| | | | ITEM # | 1-5 | 6+ | ITEM # | 1-5 | 6+ | ITEM # | 1-5 | 6+ | ITEM # | 1-5 | 6+ |
| RRR5 | 5" | .30 | 360230 | \$29.50 | \$27.00 | 360239 | \$35.00 | \$32.00 | 360248 | \$35.00 | \$32.00 | 360257 | \$35.00 | \$32.00 |
| RRR6 | 6" | .30 | 360231 | 32.00 | 28.50 | 360240 | 37.00 | 33.00 | 360249 | 37.00 | 33.00 | 360258 | 37.00 | 33.00 |
| RRR65 | 6-1/2" | .30 | 360232 | 33.00 | 29.50 | 360241 | 38.00 | 35.00 | 360250 | 38.00 | 35.00 | 360259 | 38.00 | 35.00 |
| RRR7 | 7" | .32 | 360233 | 35.00 | 32.00 | 360242 | 41.00 | 38.00 | 360251 | 41.00 | 38.00 | 360260 | 41.00 | 38.00 |
| RRR8 | 8" | .32 | 360234 | 37.00 | 33.00 | 360243 | 42.00 | 39.50 | 360252 | 42.00 | 39.50 | 360261 | 42.00 | 39.50 |
| RRR10 | 10" | .34 | 360235 | 38.00 | 35.00 | 360244 | 44.50 | 41.00 | 360253 | 44.50 | 41.00 | 360262 | 44.50 | 41.00 |
| RRR105 | 10-1/2" | .34 | 360236 | 42.00 | 39.50 | 360245 | 56.00 | 48.00 | 360254 | 56.00 | 48.00 | 360263 | 56.00 | 48.00 |
| RRR115 | 11-1/2" | .36 | 360237 | 48.00 | 41.00 | 360246 | 62.50 | 56.00 | 360255 | 62.50 | 56.00 | 360264 | 62.50 | 56.00 |
| RRR12 | 12" | .36 | 360238 | 53.50 | 44.50 | 360247 | 65.50 | 61.00 | 360256 | 65.50 | 61.00 | 360265 | 65.50 | 61.00 |
| RRR16 | 16" | .50 | 360349 | 68.00 | 64.00 | — | — | — | 360350 | 82.00 | 75.00 | — | — | — |
| RRR163 | 16-3/4" | .50 | 360351 | 82.00 | 75.00 | — | — | — | 360352 | 82.00 | 75.00 | — | — | — |

BEADED RETAINER RINGS

Retainer rings are generally used with internal halyard flagpoles by providing a means of keeping the bottom of the flag close to the pole and as an aid to raise and lower the flag. Retainer rings can also be used on large multi-grommet flags on both external and internal halyard flagpoles as a means to keep the flags close to the pole and reduce the strain on the upper and lower grommets of the flag.

These beaded rings are constructed of either 1" or combination of 1" & 2" diameter nylon balls strung onto 1/8" stainless steel aircraft cable with a stainless steel thimble attached to each end with two copper crimps. Complete with stainless steel quick link. The length of each retainer ring is determined by measuring from the outside tip of each thimble (the quick link is not included in the measurement).



| MODEL | LENGTH | POLE BUTT DIA. | DIA. OF BALLS | LBS. | WHITE | | | SILVER | | | BRONZE #313 | | | BLACK | | |
|-------|----------|----------------|---------------|------|--------|------|------|--------|------|------|-------------|------|------|--------|------|------|
| | | | | | ITEM # | 1-5 | 6+ | ITEM # | 1-5 | 6+ | ITEM # | 1-5 | 6+ | ITEM # | 1-5 | 6+ |
| RR5 | 30" | 5" | 1" | .75 | 360176 | \$68 | \$64 | 360194 | \$79 | \$73 | 360212 | \$79 | \$73 | 360488 | \$79 | \$73 |
| RR6 | 34" | 6" | 1" | .80 | 360177 | 70 | 65 | 360195 | 82 | 75 | 360213 | 82 | 75 | 360489 | 82 | 75 |
| RR7 | 38" | 7" | 1" | .85 | 360178 | 74 | 68 | 360196 | 84 | 79 | 360214 | 84 | 79 | 360490 | 84 | 79 |
| RR8 | 42" | 8" | 1" | .90 | 360179 | 75 | 70 | 360197 | 89 | 80 | 360215 | 89 | 80 | 360491 | 89 | 80 |
| RR10 | 50" | 10" | 1" | 1.1 | 360180 | 82 | 75 | 360198 | 91 | 82 | 360216 | 91 | 82 | 360492 | 91 | 82 |
| RR11 | 54" | 11" | 1" | 1.2 | 360181 | 89 | 79 | 360199 | 103 | 91 | 360217 | 103 | 91 | 360493 | 103 | 91 |
| RR12 | 58" | 12" | 1" | 1.2 | 360182 | 91 | 82 | 360200 | 107 | 93 | 360218 | 107 | 93 | 360494 | 107 | 93 |
| RR13 | 66-3/8" | 13" | 1" & 2" | 2.5 | 360183 | 176 | 156 | | | | | | | | | |
| RR14 | 70-1/2" | 14" | 1" & 2" | 2.7 | 360184 | 188 | 168 | | | | | | | | | |
| RR16 | 78-1/2" | 16" | 1" & 2" | 3.1 | 360185 | 210 | 193 | | | | | | | | | |
| RR18 | 86-1/2" | 18" | 1" & 2" | 3.4 | 360186 | 245 | 219 | | | | | | | | | |
| RR20 | 94-1/2" | 20" | 1" & 2" | 3.8 | 360187 | 266 | 245 | | | | | | | | | |
| RR22 | 102-1/2" | 22" | 1" & 2" | 4.2 | 360188 | 293 | 266 | | | | | | | | | |
| RR24 | 110-1/2" | 24" | 1" & 2" | 4.6 | 360189 | 325 | 293 | | | | | | | | | |
| RR30 | 134" | 30" | 1" & 2" | 5.8 | 360190 | 383 | 347 | | | | | | | | | |
| RR32 | 142" | 32" | 1" & 2" | 6.2 | 360191 | 408 | 367 | | | | | | | | | |
| RR34 | 152" | 34" | 1" & 2" | 6.6 | 360192 | 450 | 408 | | | | | | | | | |
| RR36 | 158" | 36" | 1" & 2" | 7.0 | 360193 | 470 | 430 | | | | | | | | | |

Beaded Retainer Rings can be mixed to achieve the higher quantity pricing.



NYLON RETAINER RING BALLS

Drilled to be strung onto 1/8" stainless steel aircraft cable.



| ITEM # | DIA. OF BALL | COLOR OF BALL | 1-99 | 100+ | LBS. |
|--------|--------------|---------------|--------|--------|------|
| 360266 | 1" | WHITE | \$1.12 | \$0.96 | .02 |
| 360267 | 1" | SILVER | 1.22 | 1.14 | .02 |
| 360268 | 1" | BRONZE | 1.22 | 1.14 | .02 |
| 360487 | 1" | BLACK | 1.22 | 1.14 | .02 |
| 360269 | 1-1/2" | WHITE | 4.80 | 4.60 | .06 |
| 360270 | 2" | WHITE | 7.30 | 6.50 | .15 |



6"



7" through 12"

INTERNAL HALYARD DOORS FOR ALUMINUM FLAGPOLES

With Lock & Keys

| MODEL | POLE DIA. | LBS. | SATIN | | | CLEAR | | | BRONZE #313 | | | WHITE | | | BLACK | | |
|-------|-----------|------|--------|-------|-------|--------|-------|-------|-------------|-------|-------|--------|-------|-------|--------|-------|-------|
| | | | ITEM # | 1-5 | 6+ | ITEM # | 1-5 | 6+ | ITEM # | 1-5 | 6+ | ITEM # | 1-5 | 6+ | ITEM # | 1-5 | 6+ |
| IHD6 | 6" | .42 | 360271 | \$238 | \$226 | 360276 | \$247 | \$234 | 360335 | \$247 | \$234 | 360281 | \$247 | \$234 | 360286 | \$247 | \$234 |
| IHD7 | 7" | .46 | 360272 | 238 | 226 | 360277 | 247 | 234 | 360336 | 247 | 234 | 360282 | 247 | 234 | 360287 | 247 | 234 |
| IHD8 | 8" | .60 | 360273 | 238 | 226 | 360278 | 247 | 234 | 360337 | 247 | 234 | 360283 | 247 | 234 | 360288 | 247 | 234 |
| IHD10 | 10" | .72 | 360274 | 270 | 265 | 360279 | 291 | 280 | 360338 | 291 | 280 | 360284 | 291 | 280 | 360289 | 291 | 280 |
| IHD12 | 12" | .76 | 360275 | 270 | 265 | 360280 | 291 | 280 | 360339 | 291 | 280 | 360285 | 291 | 280 | 360290 | 291 | 280 |



Bend in Locking Tab

LOCK & KEYS FOR INTERNAL HALYARD DOORS

This lock is suited for any of the doors listed above.



Flat Locking Tab

LOCK & KEYS FOR DOOR & FRAME UNIT

| MODEL | ITEM # | DESCRIPTION | 1-5 | 6+ | LBS. |
|-------|--------|---------------|---------|---------|------|
| IHCL | 360291 | LOCK w/2 KEYS | \$25.30 | \$23.40 | .14 |
| IHDK | 360292 | KEY ONLY | 10.90 | 10.60 | .04 |

| MODEL | ITEM # | DESCRIPTION | 1-5 | 6+ | LBS. |
|-------|--------|---------------|---------|---------|------|
| DFL | 360303 | LOCK w/2 KEYS | \$25.30 | \$23.40 | .14 |
| DFK | 360292 | KEY ONLY | 10.90 | 10.60 | .04 |



INTERNAL HALYARD DOOR & FRAME UNITS

This unit is designed for 5" diameter poles and is used with rope style internal halyard systems. Each unit consists of a hinged door mounted to the front of the frame and a cam cleat (optional) mounted to the back of the frame. The entire unit is inserted into the flagpole shaft and secured with eight 1/4"-20NC stainless steel screws. Minimum hole opening 5-1/2" x 3-1/4". Lock & keys included. Standard colors are Silver, or painted to match Clear, Bronze #313, White or Black. Please specify color when ordering. If not specified Silver will be supplied.

| DESCRIPTION | LBS. | SILVER | | | CLEAR | | | BRONZE #313 | | | WHITE | | | BLACK | | |
|----------------|------|--------|-------|-------|--------|-------|-------|-------------|-------|-------|--------|-------|-------|--------|-------|-------|
| | | ITEM # | 1-5 | 6+ | ITEM # | 1-5 | 6+ | ITEM # | 1-5 | 6+ | ITEM # | 1-5 | 6+ | ITEM # | 1-5 | 6+ |
| WITH CAM CLEAT | 3.0 | 360293 | \$245 | \$213 | — | — | — | 360297 | \$259 | \$238 | — | — | — | 360301 | \$259 | \$238 |
| NO CAM CLEAT | 2.8 | 360294 | 193 | 178 | 360296 | \$209 | \$193 | 360298 | 209 | 193 | 360300 | \$209 | \$193 | 360302 | 209 | 193 |

If medium bronze #312, light bronze #311 or a custom color is desired please specify when ordering.



CW7 & CW14

CW35

COUNTERWEIGHTS

Fabricated from 2" diameter steel and then coated with plastisol. The 3-1/2" pound weights are supplied with one eyebolt attached to one end while the 7 pound and 14 pound weights are supplied with an eyebolt attached to each end.

| MODEL | LENGTH | LBS. | WHITE | | | SILVER | | | BRONZE #313 | | | BLACK | | |
|-------|--------|------|--------|------|------|--------|------|------|-------------|------|------|--------|------|------|
| | | | ITEM # | 1-5 | 6+ | ITEM # | 1-5 | 6+ | ITEM # | 1-5 | 6+ | ITEM # | 1-5 | 6+ |
| CW35 | 3-1/2" | 3.3 | 360313 | \$66 | \$57 | 360316 | \$66 | \$57 | 360319 | \$66 | \$57 | 360513 | \$66 | \$57 |
| CW7 | 7" | 6.7 | 360314 | 89 | 80 | 360317 | 89 | 80 | 360320 | 89 | 80 | 360514 | 89 | 80 |
| CW14 | 14" | 13 | 360315 | 115 | 100 | 360318 | 115 | 100 | 360321 | 115 | 100 | 360515 | 115 | 100 |

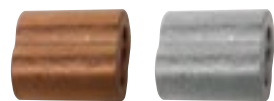

CABLE & ROPE CRIMPS

| MODEL | ITEM # | FOR CABLE OR ROPE DIA. | MATERIAL | 1-5 | 6+ | LBS. |
|--------|--------|------------------------|----------|--------|--------|------|
| CC3 | 360328 | 3/32" | COPPER | \$1.18 | \$1.06 | .01 |
| CC1 | 360324 | 1/8" | COPPER | 1.18 | 1.06 | .02 |
| CC2 | 360325 | 5/32" | COPPER | 3.28 | 3.06 | .02 |
| ARC1 | 360326 | 1/4" - 5/16" | ALUMINUM | 2.70 | 2.60 | .02 |
| ARC316 | 360500 | 3/16" | ALUMINUM | 2.70 | 2.60 | .02 |



CABLE & ROPE THIMBLES

IHTH-3 & IHTH-1 are Stainless Steel
IHTH-2 & IHTH-4 are Zinc Plated Steel

| MODEL | ITEM # | FOR CABLE OR ROPE DIA. | 1-5 | 6+ | LBS. |
|--------|--------|------------------------|--------|--------|------|
| IHTH-3 | 360331 | 3/32" | \$4.00 | \$3.60 | .02 |
| IHTH-1 | 360322 | 1/8" - 5/32" | 4.60 | 4.10 | .02 |
| IHTH-2 | 300238 | 1/8" - 5/32" | 1.58 | 1.30 | .02 |
| IHTH-4 | 360471 | 5/16" | 2.20 | 1.50 | .05 |



QUICK LINK

Stainless Steel

| MODEL | ITEM # | LENGTH | WIDTH | 1-5 | 6+ | LBS. |
|-------|--------|--------|--------|---------|---------|------|
| SSQL | 360329 | 2-7/8" | 1-3/8" | \$16.20 | \$12.10 | .20 |



COPPER CABLE STOP

| MODEL | ITEM # | FOR CABLE DIAMETER | 1-5 | 6+ | LBS. |
|-------|--------|--------------------|--------|--------|------|
| CS1 | 360327 | 1/8" | \$1.18 | \$1.06 | .01 |



CABLE SWIVEL CONNECTOR

Stainless Steel

| MODEL | ITEM # | LENGTH | WIDTH | 1-5 | 6+ | LBS. |
|--------|--------|--------|--------|--------|--------|------|
| IHCSC | 360323 | 2-3/4" | 1-1/8" | \$9.30 | \$8.90 | .20 |
| IHCSCS | 360472 | 3-5/8" | 1-3/8" | 19.20 | 18.20 | .28 |



SHOCK SPRING & SAFETY CABLE

Recommended for flagpoles which use an 8' x 12' or larger flag arrangement.

The shock spring is zinc plated high carbon steel, 5-1/2" long and 4" wide.

The safety cable is 1/8" stainless steel aircraft cable and 9" long. Each end has a stainless steel thimble attached with 2 copper crimps.

| MODEL | ITEM # | DESCRIPTION | 1-5 | 6+ | LBS. |
|-------|--------|--------------|---------|---------|------|
| IHSS | 360092 | SHOCK SPRING | \$19.20 | \$17.30 | .04 |
| SCO | 360093 | SAFETY CABLE | 12.60 | 11.30 | .02 |



STAINLESS STEEL CABLE

Priced Per Foot

| MODEL | ITEM # | DIAMETER | 1'-199' | 200'+ | LBS. |
|--------|--------|----------|---------|--------|------|
| SSC32 | 360330 | 3/32" | \$2.70 | \$2.50 | .10 |
| SSC18 | 360094 | 1/8" | 2.70 | 2.50 | .10 |
| SSC316 | 360095 | 3/16" | 3.00 | 2.70 | .10 |

STANDARD PROFILE ALUMINUM FLASH COLLARS WITH .060" WALL THICKNESS



Satin



Clear



Bronze



Black



White

The chart below contains the combinations most commonly requested. For other combinations please contact us.
5" x 12" flash collars shown above. Flash collar shape may vary depending on pole diameter & outside diameter.

| POLE DIA. | OUTSIDE DIA. | HT. | LBS. | SATIN | | | CLEAR | | | BRONZE #313 | | | BLACK | | | WHITE | | |
|-----------|--------------|--------|------|--------|----------|---------|--------|----------|----------|-------------|----------|----------|--------|----------|----------|--------|----------|----------|
| | | | | ITEM # | 1-5 | 6+ | ITEM # | 1-5 | 6+ | ITEM # | 1-5 | 6+ | ITEM # | 1-5 | 6+ | ITEM # | 1-5 | 6+ |
| 2" | 8" | 2 1/4" | .50 | 370000 | \$38.00 | \$35.00 | 320064 | \$49.00 | \$45.00 | 370048 | \$49.00 | \$45.00 | 370073 | \$66.50 | \$60.00 | 370098 | \$49.00 | \$45.00 |
| 2 3/8" | 8" | 2 1/4" | .45 | 370001 | 38.00 | 35.00 | 370025 | 49.00 | 45.00 | 370049 | 49.00 | 45.00 | 370074 | 66.50 | 60.00 | 370099 | 49.00 | 45.00 |
| 2 1/2" | 8" | 2 1/4" | .45 | 370002 | 38.00 | 35.00 | 320065 | 49.00 | 45.00 | 370050 | 49.00 | 45.00 | 370075 | 66.50 | 60.00 | 370100 | 49.00 | 45.00 |
| 2" | 12" | 1 1/4" | .80 | 370003 | 46.50 | 42.00 | 370026 | 66.50 | 60.00 | 370051 | 66.50 | 60.00 | 370076 | 74.00 | 69.50 | 370101 | 66.50 | 60.00 |
| 2 3/8" | 12" | 1 1/4" | .80 | 370004 | 46.50 | 42.00 | 370027 | 66.50 | 60.00 | 370052 | 66.50 | 60.00 | 370077 | 74.00 | 69.50 | 370102 | 66.50 | 60.00 |
| 2 1/2" | 12" | 1 1/4" | .80 | 370005 | 46.50 | 42.00 | 370028 | 66.50 | 60.00 | 370053 | 66.50 | 60.00 | 370078 | 74.00 | 69.50 | 370103 | 66.50 | 60.00 |
| 3" | 12" | 1 1/4" | .85 | 370006 | 46.50 | 42.00 | 370029 | 66.50 | 60.00 | 370054 | 66.50 | 60.00 | 370079 | 74.00 | 69.50 | 370104 | 66.50 | 60.00 |
| 3 1/2" | 12" | 1 1/4" | .80 | 370007 | 46.50 | 42.00 | 370030 | 66.50 | 60.00 | 370055 | 66.50 | 60.00 | 370080 | 74.00 | 69.50 | 370105 | 66.50 | 60.00 |
| 4" | 12" | 1 1/4" | .75 | 370008 | 46.50 | 42.00 | 370031 | 66.50 | 60.00 | 370056 | 66.50 | 60.00 | 370081 | 74.00 | 69.50 | 370106 | 66.50 | 60.00 |
| 4 3/8" | 12" | 1 1/4" | .75 | 370009 | 46.50 | 42.00 | 370032 | 66.50 | 60.00 | 370057 | 66.50 | 60.00 | 370082 | 74.00 | 69.50 | 370107 | 66.50 | 60.00 |
| 5" | 12" | 1 1/4" | .75 | 370010 | 46.50 | 42.00 | 370033 | 66.50 | 60.00 | 370058 | 66.50 | 60.00 | 370083 | 74.00 | 69.50 | 370108 | 66.50 | 60.00 |
| 5 1/2" | 12" | 1 1/4" | .70 | 370011 | 46.50 | 42.00 | 370034 | 66.50 | 60.00 | 370059 | 66.50 | 60.00 | 370084 | 74.00 | 69.50 | 370109 | 66.50 | 60.00 |
| 6" | 12" | 1 1/4" | .65 | 370012 | 46.50 | 42.00 | 370035 | 66.50 | 60.00 | 370060 | 66.50 | 60.00 | 370085 | 74.00 | 69.50 | 370110 | 66.50 | 60.00 |
| 5" | 16" | 2 1/8" | 1.4 | 370633 | 80.00 | 75.00 | 370634 | 105.00 | 95.00 | 370635 | 105.00 | 95.00 | 370636 | 120.00 | 110.00 | 370637 | 105.00 | 95.00 |
| 6" | 16" | 2 1/8" | 1.4 | 370013 | 80.00 | 75.00 | 370036 | 105.00 | 95.00 | 370061 | 105.00 | 95.00 | 370086 | 120.00 | 110.00 | 370111 | 105.00 | 95.00 |
| 7" | 16" | 2 1/8" | 1.4 | 370014 | 80.00 | 75.00 | 370037 | 105.00 | 95.00 | 370062 | 105.00 | 95.00 | 370087 | 120.00 | 110.00 | 370112 | 105.00 | 95.00 |
| 8" | 16" | 2 1/8" | 1.3 | 370015 | 80.00 | 75.00 | 370038 | 105.00 | 95.00 | 370063 | 105.00 | 95.00 | 370088 | 120.00 | 110.00 | 370113 | 105.00 | 95.00 |
| 7" | 22" | 3 5/8" | 2.5 | 370016 | 163.00 | 148.00 | 370039 | 213.00 | 196.00 | 370064 | 213.00 | 196.00 | 370089 | 231.00 | 210.00 | 370114 | 213.00 | 196.00 |
| 8" | 22" | 3 5/8" | 2.7 | 370017 | 163.00 | 148.00 | 370040 | 213.00 | 196.00 | 370065 | 213.00 | 196.00 | 370090 | 231.00 | 210.00 | 370115 | 213.00 | 196.00 |
| 10" | 22" | 3 5/8" | 2.9 | 370018 | 163.00 | 148.00 | 370041 | 213.00 | 196.00 | 370066 | 213.00 | 196.00 | 370091 | 231.00 | 210.00 | 370116 | 213.00 | 196.00 |
| 8" | 30" | 4 1/4" | 5.9 | 370019 | 390.00 | 353.00 | 370042 | 511.00 | 468.00 | 370067 | 511.00 | 468.00 | 370092 | 531.00 | 482.00 | 370117 | 511.00 | 468.00 |
| 10" | 30" | 4 1/4" | 5.4 | 370020 | 390.00 | 353.00 | 370043 | 511.00 | 468.00 | 370068 | 511.00 | 468.00 | 370093 | 531.00 | 482.00 | 370118 | 511.00 | 468.00 |
| 12" | 30" | 4 1/4" | 5.3 | 370021 | 390.00 | 353.00 | 370044 | 511.00 | 468.00 | 370069 | 511.00 | 468.00 | 370094 | 531.00 | 482.00 | 370119 | 511.00 | 468.00 |
| 8" | 38" | 4 3/4" | 7.5 | 370022 | 1,049.00 | 931.00 | 370045 | 1,189.00 | 1,069.00 | 370070 | 1,189.00 | 1,069.00 | 370095 | 1,283.00 | 1,157.00 | 370120 | 1,189.00 | 1,069.00 |
| 10" | 38" | 4 3/4" | 6.9 | 370023 | 1,049.00 | 931.00 | 370046 | 1,189.00 | 1,069.00 | 370071 | 1,189.00 | 1,069.00 | 370096 | 1,283.00 | 1,157.00 | 370121 | 1,189.00 | 1,069.00 |
| 12" | 38" | 4 3/4" | 6.7 | 370024 | 1,049.00 | 931.00 | 370047 | 1,189.00 | 1,069.00 | 370072 | 1,189.00 | 1,069.00 | 370097 | 1,283.00 | 1,157.00 | 370122 | 1,189.00 | 1,069.00 |

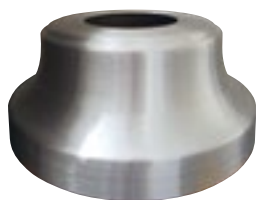

Satin

HIGH PROFILE 'TRUMPET' ALUMINUM FLASH COLLARS

Trumpet collars are generally used with flagpoles where a shoe base is welded to the bottom; however, these collars can be used on standard in-ground mounted flagpoles if a higher profile is desired. Supplied in a standard wall thickness of .060". The chart below contains the combinations most commonly requested. For other combinations please contact us.

| POLE DIA. | OUTSIDE DIA. | HT. | LBS. | SATIN | | | CLEAR | | | BRONZE #313 | | | BLACK | | | WHITE | | |
|-----------|--------------|--------|------|--------|------|------|--------|------|------|-------------|------|------|--------|-------|-------|--------|------|------|
| | | | | ITEM # | 1-5 | 6+ | ITEM # | 1-5 | 6+ | ITEM # | 1-5 | 6+ | ITEM # | 1-5 | 6+ | ITEM # | 1-5 | 6+ |
| 2 3/8" | 10" | 3 1/2" | 1.5 | 370468 | \$76 | \$70 | 370478 | \$98 | \$87 | 370488 | \$98 | \$87 | 370498 | \$112 | \$100 | 370508 | \$98 | \$87 |
| 3" | 10" | 2 3/4" | 1.5 | 370469 | 76 | 70 | 370479 | 98 | 87 | 370489 | 98 | 87 | 370499 | 112 | 100 | 370509 | 98 | 87 |
| 3" | 16" | 5 3/4" | 1.5 | 370470 | 125 | 115 | 370480 | 159 | 146 | 370490 | 159 | 146 | 370500 | 179 | 167 | 370510 | 159 | 146 |
| 4" | 16" | 5 3/4" | 1.8 | 370471 | 125 | 115 | 370481 | 159 | 146 | 370491 | 159 | 146 | 370501 | 179 | 167 | 370511 | 159 | 146 |
| 5" | 16" | 6 1/4" | 1.7 | 370472 | 125 | 115 | 370482 | 159 | 146 | 370492 | 159 | 146 | 370502 | 179 | 167 | 370512 | 159 | 146 |
| 6" | 16" | 7 1/8" | 1.7 | 370473 | 125 | 115 | 370483 | 159 | 146 | 370493 | 159 | 146 | 370503 | 179 | 167 | 370513 | 159 | 146 |
| 7" | 16" | 7 1/8" | 1.6 | 370474 | 125 | 115 | 370484 | 159 | 146 | 370494 | 159 | 146 | 370504 | 179 | 167 | 370514 | 159 | 146 |
| 8" | 16" | 7 1/8" | 1.6 | 370475 | 125 | 115 | 370485 | 159 | 146 | 370495 | 159 | 146 | 370505 | 179 | 167 | 370515 | 159 | 146 |
| 10" | 22" | 8 1/4" | 3.3 | 370476 | 254 | 227 | 370486 | 294 | 270 | 370496 | 294 | 270 | 370506 | 319 | 290 | 370516 | 294 | 270 |
| 12" | 26" | 11" | 4.9 | 370477 | 487 | 447 | 370487 | 559 | 497 | 370497 | 559 | 497 | 370507 | 580 | 518 | 370517 | 559 | 497 |

FLAGPOLES | Flash Collars (Split)

STANDARD PROFILE SPLIT ALUMINUM FLASH COLLARS WITH .060" WALL THICKNESS



Satin

A split collar can be useful when replacing or adding a collar to an installed flagpole without removing the pole from the foundation sleeve. The collar is split in half and mounting tabs with screws are installed on the under side of the collar. The quantity and size of the mounting tabs may vary depending on the size of the flash collar ordered.

| POLE DIA. | OUTSIDE DIA. | HT. | LBS. | SATIN | | | CLEAR | | | BRONZE #313 | | | BLACK | | | WHITE | | |
|-----------|--------------|-----|------|--------|-------|-------|--------|-------|-------|-------------|-------|-------|--------|-------|-------|--------|-------|-------|
| | | | | ITEM # | 1-5 | 6+ | ITEM # | 1-5 | 6+ | ITEM # | 1-5 | 6+ | ITEM # | 1-5 | 6+ | ITEM # | 1-5 | 6+ |
| 2" | 8" | 2¼" | .55 | 370233 | \$179 | \$164 | 370643 | \$186 | \$183 | 370281 | \$186 | \$183 | 370306 | \$202 | \$195 | 370331 | \$186 | \$183 |
| 2¾" | 8" | 2¼" | .50 | 370234 | 179 | 164 | 370258 | 186 | 183 | 370282 | 186 | 183 | 370307 | 202 | 195 | 370332 | 186 | 183 |
| 2½" | 8" | 2¼" | .50 | 370235 | 179 | 164 | 370644 | 186 | 183 | 370283 | 186 | 183 | 370308 | 202 | 195 | 370333 | 186 | 183 |
| 2" | 12" | 1¼" | .85 | 370236 | 182 | 179 | 370259 | 202 | 195 | 370284 | 202 | 195 | 370309 | 208 | 203 | 370334 | 202 | 195 |
| 2¾" | 12" | 1¼" | .85 | 370237 | 182 | 179 | 370260 | 202 | 195 | 370285 | 202 | 195 | 370310 | 208 | 203 | 370335 | 202 | 195 |
| 2½" | 12" | 1¼" | .85 | 370238 | 182 | 179 | 370261 | 202 | 195 | 370286 | 202 | 195 | 370311 | 208 | 203 | 370336 | 202 | 195 |
| 3" | 12" | 1¼" | .90 | 370239 | 182 | 179 | 370262 | 202 | 195 | 370287 | 202 | 195 | 370312 | 208 | 203 | 370337 | 202 | 195 |
| 3½" | 12" | 1¼" | .85 | 370240 | 182 | 179 | 370263 | 202 | 195 | 370288 | 202 | 195 | 370313 | 208 | 203 | 370338 | 202 | 195 |
| 4" | 12" | 1¼" | .80 | 370241 | 182 | 179 | 370264 | 202 | 195 | 370289 | 202 | 195 | 370314 | 208 | 203 | 370339 | 202 | 195 |
| 4¾" | 12" | 1¼" | .80 | 370242 | 182 | 179 | 370265 | 202 | 195 | 370290 | 202 | 195 | 370315 | 208 | 203 | 370340 | 202 | 195 |
| 5" | 12" | 1¼" | .80 | 370243 | 182 | 179 | 370266 | 202 | 195 | 370291 | 202 | 195 | 370316 | 208 | 203 | 370341 | 202 | 195 |
| 5½" | 12" | 1¼" | .75 | 370244 | 182 | 179 | 370267 | 202 | 195 | 370292 | 202 | 195 | 370317 | 208 | 203 | 370342 | 202 | 195 |
| 6" | 12" | 1¼" | .70 | 370245 | 182 | 179 | 370268 | 202 | 195 | 370293 | 202 | 195 | 370318 | 208 | 203 | 370343 | 202 | 195 |
| 5" | 16" | 2⅝" | 1.9 | 370645 | 210 | 204 | 370646 | 239 | 230 | 370647 | 239 | 230 | 370648 | 255 | 243 | 370649 | 239 | 230 |
| 6" | 16" | 2⅝" | 1.9 | 370246 | 210 | 204 | 370269 | 239 | 230 | 370294 | 239 | 230 | 370319 | 255 | 243 | 370344 | 239 | 230 |
| 7" | 16" | 2⅝" | 1.9 | 370247 | 210 | 204 | 370270 | 239 | 230 | 370295 | 239 | 230 | 370320 | 255 | 243 | 370345 | 239 | 230 |
| 8" | 16" | 2⅝" | 1.8 | 370248 | 210 | 204 | 370271 | 239 | 230 | 370296 | 239 | 230 | 370321 | 255 | 243 | 370346 | 239 | 230 |
| 7" | 22" | 3⅝" | 3.0 | 370249 | 311 | 293 | 370272 | 374 | 355 | 370297 | 374 | 355 | 370322 | 383 | 362 | 370347 | 374 | 355 |
| 8" | 22" | 3⅝" | 3.2 | 370250 | 311 | 293 | 370273 | 374 | 355 | 370298 | 374 | 355 | 370323 | 383 | 362 | 370348 | 374 | 355 |
| 10" | 22" | 3⅝" | 3.4 | 370251 | 311 | 293 | 370274 | 374 | 355 | 370299 | 374 | 355 | 370324 | 383 | 362 | 370349 | 374 | 355 |
| 8" | 30" | 4¼" | 6.4 | 370252 | 554 | 510 | 370275 | 662 | 615 | 370300 | 662 | 615 | 370325 | 679 | 632 | 370350 | 662 | 615 |
| 10" | 30" | 4¼" | 5.9 | 370253 | 554 | 510 | 370276 | 662 | 615 | 370301 | 662 | 615 | 370326 | 679 | 632 | 370351 | 662 | 615 |
| 12" | 30" | 4¼" | 5.8 | 370254 | 554 | 510 | 370277 | 662 | 615 | 370302 | 662 | 615 | 370327 | 679 | 632 | 370352 | 662 | 615 |
| 8" | 38" | 4¼" | 8.0 | 370255 | 1,238 | 1,119 | 370278 | 1,385 | 1,262 | 370303 | 1,385 | 1,262 | 370328 | 1,483 | 1,355 | 370353 | 1,385 | 1,262 |
| 10" | 38" | 4¼" | 7.4 | 370256 | 1,238 | 1,119 | 370279 | 1,385 | 1,262 | 370304 | 1,385 | 1,262 | 370329 | 1,483 | 1,355 | 370354 | 1,385 | 1,262 |
| 12" | 38" | 4¼" | 7.2 | 370257 | 1,238 | 1,119 | 370280 | 1,385 | 1,262 | 370305 | 1,385 | 1,262 | 370330 | 1,483 | 1,355 | 370355 | 1,385 | 1,262 |

HIGH PROFILE SPLIT 'TRUMPET' ALUMINUM FLASH COLLARS

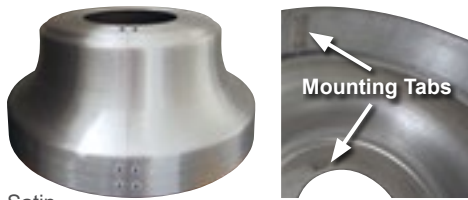

Satin

Trumpet collars are generally used with flagpoles where a shoe base is welded to the bottom; however, these collars can be used on standard in-ground mounted flagpoles if a higher profile is desired. A split collar can be useful when replacing or adding a collar to an installed flagpole without removing the pole from the foundation sleeve. The collar is split in half and mounting tabs with screws are installed on the under side of the collar. The quantity and size of the mounting tabs may vary depending on the size of the flash collar ordered. Supplied in a standard wall thickness of .060". The chart below contains the combinations most commonly requested. For other combinations please contact us.

| POLE DIA. | OUTSIDE DIA. | HT. | LBS. | SATIN | | | CLEAR | | | BRONZE #313 | | | BLACK | | | WHITE | | |
|-----------|--------------|-----|------|--------|-------|-------|--------|-------|-------|-------------|-------|-------|--------|-------|-------|--------|-------|-------|
| | | | | ITEM # | 1-5 | 6+ | ITEM # | 1-5 | 6+ | ITEM # | 1-5 | 6+ | ITEM # | 1-5 | 6+ | ITEM # | 1-5 | 6+ |
| 2¾" | 10" | 3½" | 2.0 | 370518 | \$238 | \$230 | 370528 | \$270 | \$258 | 370538 | \$270 | \$258 | 370548 | \$279 | \$270 | 370558 | \$270 | \$258 |
| 3" | 10" | 2¾" | 2.0 | 370519 | 238 | 230 | 370529 | 270 | 258 | 370539 | 270 | 258 | 370549 | 279 | 270 | 370559 | 270 | 258 |
| 3" | 16" | 5¼" | 2.0 | 370520 | 290 | 277 | 370530 | 328 | 310 | 370540 | 328 | 310 | 370550 | 337 | 321 | 370560 | 328 | 310 |
| 4" | 16" | 5¼" | 2.3 | 370521 | 290 | 277 | 370531 | 328 | 310 | 370541 | 328 | 310 | 370551 | 337 | 321 | 370561 | 328 | 310 |
| 5" | 16" | 6¼" | 2.2 | 370522 | 290 | 277 | 370532 | 328 | 310 | 370542 | 328 | 310 | 370552 | 337 | 321 | 370562 | 328 | 310 |
| 6" | 16" | 7⅞" | 2.2 | 370523 | 290 | 277 | 370533 | 328 | 310 | 370543 | 328 | 310 | 370553 | 337 | 321 | 370563 | 328 | 310 |
| 7" | 16" | 7⅞" | 2.1 | 370524 | 290 | 277 | 370534 | 328 | 310 | 370544 | 328 | 310 | 370554 | 337 | 321 | 370564 | 328 | 310 |
| 8" | 16" | 7⅞" | 2.1 | 370525 | 290 | 277 | 370535 | 328 | 310 | 370545 | 328 | 310 | 370555 | 337 | 321 | 370565 | 328 | 310 |
| 10" | 22" | 8¼" | 3.8 | 370526 | 421 | 393 | 370536 | 475 | 439 | 370546 | 475 | 439 | 370556 | 502 | 482 | 370566 | 475 | 439 |
| 12" | 26" | 11" | 5.4 | 370527 | 649 | 600 | 370537 | 728 | 662 | 370547 | 728 | 662 | 370557 | 752 | 678 | 370567 | 728 | 662 |

GALVANIZED STEEL FOUNDATION SLEEVES

The most common type of flagpole installation is the in-ground foundation sleeve method which calls for 1' of the flagpole to be encased in the ground sleeve for each 10' of exposed flagpole height. The diameter of the sleeve should be at least 2" greater than the outside diameter of the flagpole with the area between the flagpole and the sleeve filled with dry sand. Sleeves with a 6" diameter are supplied with a base plate and grounding spike. Sleeves with a diameter of greater than 6" are supplied with a base plate, support plate, grounding spike and, for ease of vertical alignment, steel centering structure welded to the inside of the base plate. If you require other sizes than listed or have special on-site conditions please contact us.

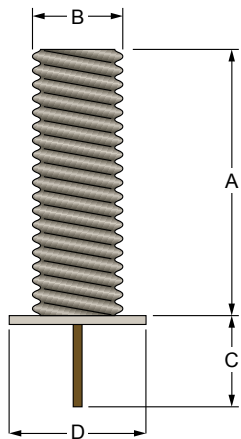

WITH BASE PLATE & GROUND SPIKE

| ITEM # | A | B | C | D | 1-5 | 6+ | LBS. |
|--------|----|----|----|----|-------|-------|------|
| 380000 | 2' | 6" | 6" | 8" | \$143 | \$137 | 20 |
| 380002 | 3' | 6" | 6" | 8" | 184 | 178 | 24 |

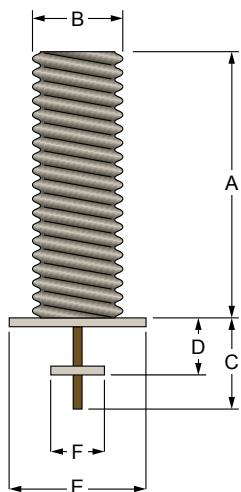

WITH BASE PLATE, SUPPORT PLATE, GROUNDING SPIKE & STEEL CENTERING STRUCTURE

| ITEM # | A | B | C | D | E | F | 1-5 | 6+ | LBS. |
|--------|--------|-----|-----|-----|-----|-----|-------|-------|------|
| 380003 | 3' | 8" | 18" | 6" | 12" | 6" | \$260 | \$237 | 30 |
| 380004 | 3-1/2' | 8" | 18" | 6" | 12" | 6" | 266 | 246 | 32 |
| 380005 | 3' | 10" | 18" | 6" | 16" | 8" | 280 | 265 | 37 |
| 380006 | 3-1/2' | 10" | 18" | 6" | 16" | 8" | 299 | 285 | 44 |
| 380007 | 4' | 12" | 18" | 6" | 16" | 8" | 403 | 385 | 55 |
| 380196 | 4-1/2' | 12" | 18" | 6" | 16" | 8" | 433 | 408 | 60 |
| 380008 | 5' | 12" | 18" | 6" | 18" | 9" | 474 | 450 | 70 |
| 380009 | 5' | 15" | 18" | 6" | 20" | 10" | 840 | 797 | 86 |
| 380010 | 6' | 15" | 24" | 10" | 20" | 10" | 970 | 928 | 122 |
| 380011 | 6' | 18" | 24" | 10" | 24" | 12" | 1,077 | 1,022 | 135 |
| 380012 | 7' | 15" | 24" | 12" | 24" | 12" | 1,077 | 1,022 | 141 |
| 380013 | 7' | 18" | 24" | 12" | 24" | 12" | 1,249 | 1,187 | 156 |
| 380014 | 8' | 18" | 24" | 12" | 24" | 12" | 1,334 | 1,271 | 160 |

PVC SLEEVES

Poles slip into form fit sleeves snugly - no voids to fill with sand. Standard sleeves require wood wedges & sand for a proper installation.



| ITEM # | FOR POLE DIA. | LEN. | TYPE | 1-5 | 6+ | LBS. |
|--------|---------------|------|----------|---------|--------|------|
| 380015 | 1-3/8" | 12" | FORM FIT | \$10.80 | \$9.50 | .14 |
| 380016 | 1-5/8" | 15" | FORM FIT | 12.80 | 11.60 | .20 |
| 380017 | 1-3/4" | 20" | FORM FIT | 14.80 | 13.50 | .26 |
| 380018 | 2" | 15" | FORM FIT | 19.30 | 17.20 | .25 |
| 380020 | 2" | 20" | FORM FIT | 20.90 | 19.30 | .34 |
| 380021 | 2-1/2" | 30" | FORM FIT | 28.00 | 26.40 | 1.1 |
| 380022 | 3" | 20" | FORM FIT | 34.40 | 32.70 | .95 |
| 380023 | 3"-3 1/2" | 24" | STANDARD | 30.20 | 28.60 | 1.6 |
| 380024 | 3"-3 1/2" | 30" | STANDARD | 41.40 | 40.10 | 1.9 |

GALVANIZED STEEL ANCHOR BOLTS

For Shoe Base Installations

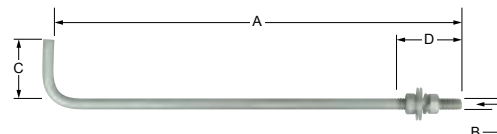

Complete with 2 Hex Nuts, 2 Washers & 1 Lock Washer

| ITEM # | A | B | C | D | 1-5 | 6+ | LBS. |
|--------|-----|--------|--------|----|------|------|------|
| 380037 | 16" | 5/8" | 3-1/2" | 4" | \$41 | \$37 | 2.4 |
| 380038 | 24" | 3/4" | 4" | 5" | 44 | 40 | 3.5 |
| 380039 | 36" | 1" | 4" | 6" | 79 | 77 | 8.4 |
| 380040 | 40" | 1" | 4" | 6" | 87 | 84 | 9.0 |
| 380041 | 54" | 1-1/4" | 6" | 8" | 210 | 190 | 29 |

COPPER CLAD LIGHTNING KIT

Each kit contains 5' long by 1/2" diameter copper clad rod, one 3' long by 1/2" diameter copper wire plus one connecting bracket.



COMPLETE SET

| ITEM # | 1-5 | 6+ | LBS. |
|--------|-------|-------|------|
| 380033 | \$190 | \$170 | 4.5 |

5' X 1/2" ROD ONLY

| ITEM # | PRICE | LBS. |
|--------|-------|------|
| 380035 | \$106 | 1.2 |

WIRE ONLY

| ITEM # | PER FOOT | LBS. |
|--------|----------|------|
| 380034 | \$15.60 | .36 |

BRACKET ONLY

| ITEM # | 1-5 | 6+ | LBS. |
|--------|------|------|------|
| 380036 | \$58 | \$54 | .36 |

THRU WALL BOLTS

For Mounting Outrigger & Vertical Wall Mount Brackets

Zinc plated steel complete with one acorn nut, one hex nut, two washers & two lock washers.



| ITEM # | SIZE | COLOR | 1-5 | 6+ | LBS |
|--------|------------|--------|---------|---------|-----|
| 380048 | 5/8" x 6" | SILVER | \$24.50 | \$23.50 | .75 |
| 380049 | 5/8" x 12" | SILVER | 29.00 | 28.00 | 1.2 |
| 380050 | 5/8" x 18" | SILVER | 29.50 | 28.00 | 1.7 |
| 380051 | 5/8" x 24" | SILVER | 30.50 | 28.50 | 2.1 |
| 380052 | 5/8" x 30" | SILVER | 31.50 | 30.50 | 2.5 |
| 380053 | 5/8" x 36" | SILVER | 35.50 | 31.00 | 2.9 |

MOUNTING BOLTS WITH EXPANSION SHIELDS

For Mounting Outrigger & Vertical Wall Mount Brackets

Zinc plated steel complete with one acorn nut, one washer & one lock washer.



| ITEM # | SIZE | COLOR | 1-5 | 6+ | LBS |
|--------|-----------|--------|---------|---------|-----|
| 380103 | 5/8" x 6" | SILVER | \$28.00 | \$26.50 | .81 |



TUNNEL LIGHTS

Sold in sets only – 18" long by 6" diameter aluminum cylinders. Fixtures accept 150 watt flood lamps for up, down or up/down lighting (lamps not included in pricing below). See table below for wiring set-up cost not included in tunnel light pricing.

| ADD ON FOR FACTORY SET-UP OF WIRING | POLE TYPE | ACCESS DOOR | PRICE |
|---|-----------|-------------|----------|
| | EXTERNAL | NO | \$560.00 |
| | EXTERNAL | YES | 1,000.00 |
| | INTERNAL | NO | 680.00 |
| | INTERNAL | YES | 1,260.00 |

Electrical access doors can only be supplied on 5" and larger diameter poles. Minimum wall thickness .156. For tunnel lights with access door, please allow 8-10 weeks of lead time.

| FOR POLE DIA. | LBS | SILVER | | | CLEAR | | | BRONZE #313 | | | WHITE | | | BLACK | | |
|---------------|-----|--------|---------|---------|--------|---------|---------|-------------|---------|---------|--------|---------|---------|--------|---------|---------|
| | | ITEM # | 1-5 | 6+ | ITEM # | 1-5 | 6+ | ITEM # | 1-5 | 6+ | ITEM # | 1-5 | 6+ | ITEM # | 1-5 | 6+ |
| 5" – 7" | 18 | 380112 | \$1,670 | \$1,510 | 380119 | \$1,920 | \$1,720 | 380126 | \$1,920 | \$1,720 | 380133 | \$1,920 | \$1,720 | 380140 | \$1,920 | \$1,720 |
| 8" – 12" | 18 | 380116 | 1,920 | 1,720 | 380123 | 2,090 | 1,920 | 380130 | 2,090 | 1,920 | 380137 | 2,090 | 1,920 | 380144 | 2,090 | 1,920 |



TUNNEL LIGHT REPLACEMENT LENS

| ITEM # | 1-5 | 6+ | LBS |
|--------|-------|-------|-----|
| 380190 | \$240 | \$220 | .33 |



DELUXE LED SOLAR FLAGPOLE LIGHT

This solar-powered flagpole light is ideal for residential flagpoles 15' to 25'

- 200 x 1W ultra brite SMD 2835 LEDs, 1100 lumens
- Two 3.2V 3600 mAh LiFePO4 batteries(7200mAh total)
- 5v 6.2w efficiency monocrystalline solar panels
- IP65 rated water resistant
- Light Dimension is 10" x 10" x 1.5"
- For use with all trucks except for the ST series



OBSTRUCTION (BEACON) LIGHT

This light measures 6" x 4-3/4" and is ideal for taller flagpoles near airports or flight paths. ETL verified to FAA standards. Supplied standard with LED steady-burn bulb; please contact us if flasher unit is required. Set-up of flagpole to accept this lighting fixture can be done at the factory; call for pricing.

| MODEL | ITEM # | 1-5 | 6+ | LBS. |
|-------|--------|-------|-------|------|
| OL-R | 380148 | \$650 | \$620 | 2.8 |

| Item# | DESCRIPTION | 1-5 | 6+ | LBS |
|--------|----------------------|-------|-------|-----|
| 380209 | SOLAR FLAGPOLE LIGHT | \$126 | \$119 | 1.9 |

NON-TANGLE RODS

For Wall Mounted Outrigger Flagpoles

Constructed of 3/8" diameter stainless steel rod. All sizes are supplied complete with a stainless steel fitting which attaches to the grommet of the flag. 30" and 48" long rods are supplied with one stainless steel fitting which attaches to the bottom edge of the flag while the 72" and 84" rods are supplied with three stainless steel fittings which attach to the bottom edge of the flag. **Note: A reinforcing patch must be sewn into the flag in order for the flag clamp to properly attach. Rope and flag must be routinely inspected for wear and loose connections to avoid property damage and/or personal injury.**



| MODEL | ITEM # | LENGTH | FOR FLAG SIZE | 1-5 | 6+ | LBS. |
|--------|--------|--------|--------------------|-------|-------|------|
| NTR-30 | 390000 | 30" | 3' x 5' or 4' x 6' | \$240 | \$230 | 1.6 |
| NTR-48 | 390001 | 48" | 5' x 8' | 265 | 240 | 2.3 |
| NTR-72 | 390002 | 72" | 6' x 10' | 365 | 325 | 3.1 |
| NTR-84 | 390003 | 84" | 8' x 12' | 375 | 345 | 4.3 |

FLAGPOLE PLAQUES

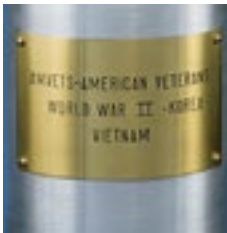

Engraved brass plaques are available and are curved to fit the butt diameter of the flagpole. Letter styles available are block or roman style. The plaques are supplied with brass rivets which are included.

Please specify flagpole base diameter when ordering.

**BLOCK
STYLE
LETTERING**

**ROMAN
STYLE
LETTERING**

| POLE DIAMETER | PRICE |
|--------------------|------------------------------|
| 3-1/2" AND SMALLER | \$113.00 + \$5.45 PER LETTER |
| 4" THROUGH 8" | \$144.00 + \$5.45 PER LETTER |
| GREATER THAN 8" | CALL FOR PRICING |



TOUCH-UP PAINT

12 oz. Aerosol Spray

| MODEL | ITEM # | COLOR | 1-5 | 6+ |
|---------|--------|-------------------|------|------|
| TUP-AL | 390006 | ALUMINUM | \$61 | \$58 |
| TUP-311 | 390007 | LIGHT BRONZE #311 | 61 | 58 |
| TUP-312 | 390008 | MED. BRONZE #312 | 61 | 58 |
| TUP-313 | 390009 | DARK BRONZE #313 | 61 | 58 |
| TUP-BL | 390010 | BLACK | 61 | 58 |
| TUP-WH | 390011 | WHITE | 61 | 58 |
| TUP-G | 390012 | GOLD | 61 | 58 |

Weight for each can is approximately 1.0 lbs.
Aerosol sprays cannot be shipped by air freight.

5' FLAGPOLE MOCK-UPS

| POLE TYPE | MODEL | ITEM # | PRICE | LBS. |
|---------------------------|-------|--------|-------|------|
| EXTERNAL HALYARD | FMU-X | 390013 | \$730 | 19 |
| VANGUARD INTERNAL HALYARD | FMU-Y | 390014 | 930 | 22 |
| M-WINCH INTERNAL HALYARD | FMU-M | 390015 | 1,710 | 25 |

External Halyard

Vanguard Internal Halyard

M-Winch Internal Halyard



WHEN TO DISPLAY THE FLAG

The flag should be displayed on all days when weather permits, especially on legal holidays or other special occasions. It is customary to display the flag from sunrise to sunset on buildings or on stationary flagstaffs in the open. However, on special occasions it may be displayed at night, preferably lighted. In several places the flag flies day and night; among these are the Capitol in Washington, D.C., and the Fort Henry National Monument in Baltimore, which was the inspiration for "The Star Spangled Banner" by Francis Scott Key.

The flag should be displayed...

- on or near the main administration building of every public institution
- in or near polling places on election days
- in or near schools when they are in session

A citizen may fly the flag on any day he wishes.

HOW TO FLY THE FLAG

The flag should be raised and lowered by hand. Never, raise the flag while it is furled; unfurl, then hoist quickly to the peak of the flagstaff. It should be lowered slowly and ceremoniously. The flag should never be allowed to touch anything beneath it, such as the ground or the floor.

The flying of the flag at half-staff, is a sign of mourning. When flown at half-staff, the flag should be first hoisted to the peak, then immediately lowered to the half-staff position. It should be raised to the peak again for a moment before it is lowered for the day. "Half-staff" is the point midway between the top and bottom of the flagstaff. On Memorial Day in May, the flag should fly at half-staff from sunrise until noon, and at full-staff from noon until sunset.

At sea services by Navy chaplains, the church pennant may be flown above the flag.

No other flag may be flown above The United States flag except at the United Nations Headquarters. The UN flag may be placed above flags of all member nations. In the UN enclave, national flags of all members are flown with equal prominence.

When the flags of two or more nations are displayed together they should be flown from separate staffs of the same height, and the flags should be of approximately equal size. International usage forbids the display of the flag of one nation above that of another in time of peace.

HOW TO DISPLAY THE FLAG

When carried in procession with another flag or flags, the Stars and Stripes should be at the right-front of the column, or when there is a line of other flags, in front of the center of that line. The flag should never be carried flat or horizontally, but always aloft and floating free.

When a number of flags are grouped and displayed from staffs, the flag of the United States should be in the center or at the highest point of the group. When displayed with another flag from crossed staffs, the flag of the United States should be on the right (the flag's own right), and its staff should be in front of the staff of the other flag.

If the flag is displayed from a staff projected from a window sill, balcony or front of a building, the union of the flag should go to the peak of the staff (unless the flag is to be displayed at half-staff).

When the flag is displayed in any manner other than being flown from a staff, it should be displayed flat, whether indoors or out. If displayed either horizontally or vertically against a wall, the union should be uppermost and to the flag's own right; that is to the observer's left. When displayed in a window it should be suspended in the same way—that is, with the union to the left of the observer in the street.

When displayed over the middle of the street, the Stars and Stripes should be suspended vertical with the union to the north on an east-west street and to the east on a north-south street.

When the flag is suspended over a sidewalk from a rope extending from house to pole at the edge of the sidewalk, the flag should be hoisted out from the building toward the pole union first.

When used on a speaker's platform the flag may be displayed flat, above and behind the speaker. If flown from a staff it should be on the speaker's right; all other flags on the platform should be on his left.

When it is displayed on the pulpit or chancel in a church, the flag should be flown from a staff placed on the clergyman's right as he faces the congregation. All other flags on the pulpit or chancel should be on his left.

However, when the flag is displayed on the floor of a church or auditorium, on a level with the audience, it is placed to the right of the audience.

When flags of states or cities, or pennants of societies, are flown on the same halyard with the flag of the United States, the latter should always be at the peak. When flown from adjacent staffs, the Stars and Stripes should be raised first and lowered last.

When used to cover a casket, the flag should be placed so that the union is at the head and over the left shoulder. The flag should not be lowered into the grave or allowed to touch the ground. The casket should be carried foot-first from the hearse to the grave.

SALUTING THE FLAG

In saluting the flag those present in uniform should render the military salute. When not in uniform, men should remove the hat with the right hand and hold it at the left shoulder, the hand being over the heart. Women, and men without hats, should place the right hand over the heart. Aliens should stand at attention.

All persons present should face the flag, stand at attention and salute on the following occasions:

1. When the flag is passing in a parade or review. The salute to the flag in the moving column is rendered at the moment the flag passes.
2. During the ceremony of hoisting or lowering the flag.
3. When the National Anthem is played and the flag is displayed.
4. During the Pledge of Allegiance...I pledge allegiance to the flag of the United States of America and to the Republic for which it stands, one Nation under God, indivisible, with liberty and justice for all.

When the National Anthem is played and the flag is not displayed, all present should stand and face toward the music. Those in uniform should salute at the first note of the anthem, retaining this position until the last note. All others should stand at attention, men removing their hats. When the flag is displayed, all present should face the flag and salute.

HOW TO DISPOSE OF WORN FLAGS

Every precaution should be taken to prevent the flag from becoming soiled. When a flag is in such a condition, through wear or damage, that is no longer a fitting emblem for display, it should be destroyed privately in a dignified manner.

The flag should NEVER

1. Be tilted (dipped) even momentarily to any person or thing. Regimental colors, State flags, organization or institutional flags may be tilted as the mark of honor.
2. Be displayed with the union down except as a signal of distress.
3. Be carried flat or horizontally, but always aloft and floating free.
4. Be displayed on a float, motor car or boat except from a staff.
5. Be allowed to touch the ground or floor, or brush against objects.
6. Have objects placed on, over it, or be used as a covering for a ceiling.
7. Have any mark, insignia, letter, work, figure, picture or drawing of any nature placed upon or attached to it.
8. Be used as a receptacle for carrying anything, or be used to cover a statue or monument. If used in connection with unveiling ceremonies, it should not serve as a covering of the object being unveiled.

9. Be used for advertising purposes or have advertising signs fastened to its staff or halyard.
10. Be embroidered on such articles as handkerchiefs or cushions, or be printed or otherwise impressed on boxes.
11. Be used as a costume or athletic uniform or part of one.
12. Be used as drapery of any sort whatsoever, never festooned, drawn back or up in folds, but always allowed to fall free. Bunting of blue, white and red—always arranged with the blue above, white in the middle, and red below—should be used for such purposes of decoration as covering a speaker's desk or draping the front of a platform.

FLAG ETIQUETTE BROCHURE

This fully illustrated brochure contains all of the etiquette printed on this page plus a "FLAG HOLIDAYS" and "CARING FOR YOUR FLAG" section. Measures 8" x 5-1/4".



| MODEL | ITEM # | 1-49 | 50+ | LBS. |
|-------|--------|--------|--------|------|
| ETQ-B | 420000 | \$1.44 | \$1.34 | .02 |

FLAG ETIQUETTE BOOKLET

An abbreviated version of our Flag Etiquette brochure which measures 3-1/2" x 2-3/4" is also available.

| MODEL | ITEM # | 1-99 | 100+ | LBS. |
|-------|--------|--------|--------|------|
| ETQ-S | 420001 | \$0.36 | \$0.32 | .001 |

We truly believe in our quality of materials and workmanship; therefore, our tapered aluminum flagpole shafts are covered by a Lifetime Warranty. Specific details on our warranty can be found in the document below.

We are honored to provide you this continued confidence when you are purchasing a commercial flagpole from Eder Flag.



Lifetime Warranty

Eder Flag Lifetime Aluminum Cone Tapered Commercial Flagpole Shaft Warranty

Eder Flag Manufacturing Company warrants for their intended use lifetime that the aluminum tapered flagpole shafts that we manufacture will be made of the best workmanship and free of defects in material at the time of shipment. When materials furnished on this job are used for the purpose intended, we hereby warrant the cone tapered aluminum flagpole shaft(s) shipped after May 1, 2017.

This intended use lifetime warranty extended to the original purchaser covers the aluminum cone tapered flagpole shaft only and does not include any accessories or connecting hardware. The accompanying hardware (with the exception of snaps, rope, ornaments or cable) is warranted for one (1) year from date of purchase.

Items damaged by improper installation and/or grounding, overloading with incorrect flag size, accident, vandalism, vehicular impact or neglect by owner are not covered by this guarantee. This shaft warranty does not include failures with following site conditions: wind induced vibrations and corrosive soils with low (under 5) pH values (Alkaline) or high (over 9) pH values (Acidic).

Guarantee will not be honored if any alterations, modifications, or additions are made to our product unless the latter is approved in writing by Eder Flag Mfg. Co., Inc. No claims for labor, dismantling, transportation, or re-erection will be honored. Eder Flag shall not be liable for any other loss or damage, including but not limited to consequential or liquidated damages, or back charges. Material that needs to be returned will require a written authorization form from our firm, which will include correct shipping instructions. Material returned without return authorization will not be accepted.

This warranty excludes any finishes such as powder coating and anodizing processes.

Eder Flag Manufacturing Company will, at its sole discretion repair, replace or credit original Buyer's account for any product that does not conform to this warranty. Eder Flag makes no other warranties, express or implied, which extend beyond the description on the face hereof.

**Eder Flag Mfg. Co., Inc. | 1000 W. Rawson Avenue | Oak Creek, WI 53154
800-558-6044 | Fax 414-764-1039 | www.ederflag.com**

The largest company in America that serves as both a flag and flagpole manufacturer.

All sales will be subject to the terms and conditions contained herein. An objection by Buyer to any of the terms contained herein shall be deemed to have been waived if we do not receive the objection in writing within 10 days of receipt of invoice or acknowledgment or before part of the merchandise or services is accepted by Buyer, whichever may occur first.

- 1. WARRANTY DISCLAIMER.** All products made by Seller are inspected before shipment. If any goods prove to have been defective in material or workmanship at time of shipment, a claim shall be made by Buyer pursuant to the provisions set forth below, Seller will repair or replace the goods, at Seller's option. Unless otherwise agreed by Seller in writing, Seller makes no warranties, express or implied, including but not limited to implied warranties of merchantability or fitness for a particular purpose. In no event shall Seller be liable to Buyer for incidental or consequential damages.
- 2. STATUTE OF LIMITATIONS.** Any action by Buyer against Seller for breach of contract or any other legal theory must be commenced by Buyer within (1) year after the cause of action has occurred.
- 3. RETURNS.** All returns must be authorized in advance by Seller within (10) days of receipt of goods by Buyer. Buyer must pre-pay all freight on authorized returned goods. Freight claims resulting from return shipment are the responsibility of Buyer. Credit on account minus a restocking charge will be made upon inspection of returned goods. Custom, non-stock and special order items are not returnable. Returns will not be accepted after (10) days from receipt of merchandise and no adjustments of any kind will be made after 180 days from receipt of merchandise.
- 4. SHORTAGES.** Claims for shortages must be made by Buyer within 48 hours of receipt of the goods, and no claims made after the expiration of such period will be entertained or allowed.
- 5. DELAYS.** All orders are accepted by Seller upon the express understanding by the Buyer that Seller shall not be liable for delays in delivery of the goods or inability to deliver the goods caused by or due to inability to obtain transportation, equipment, or material, or by reason of fires, floods, storms, embargoes, actions of any military or civil authorities, whether legal or de facto, strikes, labor difficulties, riots, lock outs, acts of God, or similar or different circumstances beyond the control of the Seller.
- 6. FREIGHT.** All costs of freight, transportation, or mailing, unless prepaid, and all demurrage charges shall be paid by Buyer. Buyer shall also pay for all increased freight rates whether prepayment for freight rates has been made or not. Likewise, if freight charges have been prepaid and the actual freight charges are less than quoted, Buyer forfeits the difference.
- 7. WAIVER.** A waiver by Seller of any breach by Buyer shall not constitute a waiver by Seller of any other breach by Buyer.
- 8. DELIVERY.** Delivery of the goods by Seller to the carrier at the point of origin shall constitute delivery of the goods to Buyer and thereafter the shipment of the goods shall be at Buyer's risk. All claims and allowances for damage to the merchandise incurred in transit must be filed against and presented to the carrier by Buyer. Goods sent by mail are insured at cost of Buyer.
- 9. PAYMENT.** Prices Net 15 to approved credit. Terms are from date of invoice and not from date the goods are received. No extra dating. All payments shall be made in U.S. dollars. Any amounts past due are subject to a service charge of 1.5% per month (18% annually) starting 30 days after invoice date. The minimum merchandise billing amount of \$75.00 net and a service charge of \$5.00 will be charged on orders less than the minimum. **Credit/Debit Card Payments:** All credit/debit card payments will incur a convenience fee. If a credit/debit card payment is used at time of shipment, a 2% convenience fee will be added to the invoice. If a credit/debit card payment is used to pay an outstanding balance, net terms, a 3% convenience fee will be added to the invoice total. ACH and check payments are the preferred method of payment.
- 10. CUSTOM PRODUCT.** Custom screen printed banners and flags are subject to variation in quantity. All orders subject to plus/minus 10% variance. Order accepted only on the basis that final invoice will reflect actual quantity delivered and Buyer agrees to accept and pay for overruns. All prices and specifications subject to change without notice.
- 11. CANCELLATIONS.** Orders for custom, non-stock and special order items cannot be cancelled except upon terms acceptable to Seller that will compensate Seller for costs incurred.

Continued on next page

- 12. BACK ORDERS.** Sellers policy is to ship all available merchandise and back order the balance unless otherwise specified by the Buyer. Therefore, Buyer must accept partial shipments and pay partial invoices and additional freight charges within Sellers payment terms.
- 13. DIES, TOOLS AND PATTERNS.** Charges made for dies, tools and patterns are part of the purchase price of the goods and do not convey ownership to Buyer. All dies, tools and patterns remain the property of Seller, unless agreed by Seller in writing.
- 14. COLLECTION.** Any collection fees, legal fees and/or court costs will be the responsibility of the Buyer in event of default based upon the terms of this agreement. In respect to such matters, legal fees by Buyer to Seller will be defined as thirty-three and one-third percent (33⅓%) of any unpaid invoice. The jurisdiction of any and all legal disputes is the Circuit Court of Milwaukee County, Wisconsin. All parties waive the right to trial by jury.

- 15. SHIPPING WEIGHTS, PRICES and SPECIFICATIONS.** Weights published by Seller are approximate and will vary according to size of shipping carton and/or packaging materials used. Weights are published for determining approximate freight charges by Buyer. Seller is not responsible for any difference in calculated freight charges versus actual freight charges. All prices and specifications are subject to change without notice.
- 16. HANDLING FEES AND TAXES.** A \$3.00 Shipping and Handling fee is added to each invoice. The appropriate State sales tax will be applied regarding shipments to the following States: Florida, Illinois, Wisconsin and any other State that charges a sales tax unless a proper tax exemption certificate is received by Seller that has been issued by the subject State.
- 17. PRICING AND AVAILABILITY DISCLAIMER.** All pricing is subject to change. Eder Flag reserves the right to make adjustments to pricing, product and service offerings for reasons including, but not limited to, changing market condition, production discontinuations, product unavailability and errors in advertisements. All orders may be subject to product availability.

We accept VISA, MasterCard and American Express



The largest company in America that serves as both a flag and flagpole manufacturer.

YOUR COMPLETE SOURCE FOR
Flags, Flagpoles & Accessories

Eder Flag Manufacturing Company, Inc.
1000 W. Rawson Ave. • P.O. Box 397
Oak Creek, Wisconsin 53154-0397

Phone: 414-764-3522
Toll Free Phone: 800-558-6044
Sales Department Fax: 414-764-1039
Toll Free Fax: 800-EDER FAX (333-7329)

www.ederflag.com